

# Puritan Bennett™

## 560 Ventilator



COVIDIEN, COVIDIEN with logo, and the Covidien logo and Positive Results for Life are U.S. and internationally registered trademarks of Covidien AG. <sup>TM\*</sup> brands are trademarks of their respective owners. All other brands are trademarks of a Covidien company.

The information contained in this manual is the sole property of Covidien and may not be duplicated without permission. This manual may be revised or replaced by Covidien at any time and without notice. You should ensure that you have the most current applicable version of this manual; if in doubt, contact Covidien's Technical Support department or visit the product manuals web page at:

[www.medtronic.com/covidien/support/product-manuals](http://www.medtronic.com/covidien/support/product-manuals)

While the information set forth herein is believed to be accurate, it is not a substitute for the exercise of professional judgment.

The ventilator should be operated and serviced only by trained professionals. Covidien's sole responsibility with respect to the ventilator, and its use, is as stated in the limited warranty provided.

Nothing in this manual shall limit or restrict in any way Covidien's right to revise or otherwise change or modify the equipment (including its software) described herein, without notice. In the absence of an express, written agreement to the contrary, Covidien has no obligation to furnish any such revisions, changes, or modifications to the owner or user of the equipment (including its software) described herein.

To obtain information about a warranty, if any, contact Covidien Technical Services at 1 800 635 5267 or your local representative.

Purchase of this instrument confers no express or implied license under any Covidien patent to use the instrument with any ventilator that is not manufactured or licensed by Covidien.

---

# Table of Contents

## Preface

<b>Purpose of This Manual</b>	xvii
<b>Qualification of Personnel</b>	xvii
<b>Warranty</b>	xvii
<b>Extended Service</b>	xvii
<b>Service Centers</b>	xviii

## 1 Safety Information

<b>1.1</b>	<b>Definitions</b>	<b>1-1</b>
<b>1.2</b>	<b>Warnings</b>	<b>1-1</b>
1.2.1	General Warnings Regarding Use of Equipment	1-1
1.2.2	Warnings Regarding Installation and Environment of Use	1-4
1.2.3	Warnings Regarding Electrical Power Supplies	1-7
1.2.4	Warnings Regarding Hoses and Accessories	1-8
1.2.5	Warnings Regarding Settings	1-11
1.2.6	Warnings Regarding PC Connection and USB Memory Devices	1-14
1.2.7	Warnings Regarding Maintenance	1-14
1.2.8	Warnings Regarding Oxygen	1-17
1.2.9	Warnings Regarding Electromagnetic Interference	1-19
<b>1.3</b>	<b>Symbols and Markings</b>	<b>1-19</b>
<b>1.4</b>	<b>Labels (Identification and Instruction Information)</b>	<b>1-24</b>

## 2 Ventilator Overview

<b>2.1</b>	<b>Indications for Use</b>	<b>2-1</b>
2.1.1	Target Patients	2-1
2.1.2	Target Environments	2-1
2.1.3	Target Operators	2-2
<b>2.2</b>	<b>Contraindications</b>	<b>2-2</b>
<b>2.3</b>	<b>Operational Use</b>	<b>2-2</b>
2.3.1	Safety Net	2-3
2.3.2	Settings	2-3
2.3.3	Oxygen Enrichment	2-3
2.3.4	Breathing Circuit	2-3
<b>2.4</b>	<b>Device Classification</b>	<b>2-3</b>
<b>2.5</b>	<b>Front Panel</b>	<b>2-4</b>
<b>2.6</b>	<b>Back Panel</b>	<b>2-5</b>
<b>2.7</b>	<b>Control Panel</b>	<b>2-6</b>
<b>2.8</b>	<b>Ventilation Menu</b>	<b>2-7</b>
<b>2.9</b>	<b>Alarm Menu</b>	<b>2-8</b>
<b>2.10</b>	<b>Waveforms Menu</b>	<b>2-9</b>
<b>2.11</b>	<b>USB Memory Device Menu</b>	<b>2-10</b>
<b>2.12</b>	<b>If Ventilator Failure Occurs</b>	<b>2-10</b>

---

# Table of Contents

## 3 Operating Parameters

<b>3.1</b>	<b>Overview</b> .....	<b>3-1</b>
<b>3.2</b>	<b>PSV Mode Parameters and Setting Ranges</b> .....	<b>3-2</b>
3.2.1	P Support—Pressure Support .....	3-3
3.2.2	PEEP—Positive End Expiratory Pressure .....	3-3
3.2.3	Rise Time .....	3-4
3.2.4	I Sens—Inspiratory Trigger Sensitivity .....	3-4
3.2.5	E Sens—Exhalation Sensitivity .....	3-5
3.2.6	Backup R—Backup Rate .....	3-5
3.2.7	Apnea Time .....	3-6
3.2.8	Vt Target—Target Tidal Volume .....	3-6
3.2.9	Max P—Maximum Inspiration Pressure .....	3-6
3.2.10	Min and Max I Time—Minimum and Maximum Inspiration Time .....	3-7
3.2.11	Min and Max VTI—Minimum and Maximum Inspiratory Tidal Volume .....	3-7
3.2.12	Min and Max VTE—Minimum and Maximum Exhalation Tidal Volume .....	3-7
3.2.13	Max Leak—Maximum Leakage .....	3-8
3.2.14	Max Rtot—Maximum Total Breath Rate .....	3-8
3.2.15	Min and Max FiO <sub>2</sub> —Minimum and Maximum Fraction of Inspired Oxygen .....	3-8
<b>3.3</b>	<b>CPAP Mode Parameters and Setting Ranges</b> .....	<b>3-9</b>
3.3.1	PEEP—Positive End Expiratory Pressure .....	3-10
3.3.2	Apnea Time .....	3-10
3.3.3	Min and Max VTI—Minimum and Maximum Inspiratory Tidal Volume .....	3-10
3.3.4	Max Leak—Maximum Leakage .....	3-10
3.3.5	Max Rtot—Maximum Total Breath Rate .....	3-11
3.3.6	I Sens—Inspiratory Trigger Sensitivity .....	3-11
3.3.7	E Sens—Exhalation Trigger Sensitivity .....	3-11
3.3.8	Min and Max FiO <sub>2</sub> —Minimum and Maximum Fraction of Inspired Oxygen .....	3-11
<b>3.4</b>	<b>P A/C Mode Parameters and Setting Ranges</b> .....	<b>3-12</b>
3.4.1	Pi—Inspiratory Pressure .....	3-13
3.4.2	PEEP—Positive End Expiratory Pressure .....	3-14
3.4.3	Rise Time .....	3-14
3.4.4	Rate—Respiratory Rate .....	3-14
3.4.5	Insp Time—Inspiratory Time .....	3-15
3.4.6	I Sens—Inspiratory Trigger Sensitivity .....	3-15
3.4.7	Vt Target—Target Tidal Volume .....	3-15
3.4.8	Max P—Maximum Inspiration Pressure .....	3-15
3.4.9	Min and Max VTI—Minimum and Maximum Inspiratory Tidal Volume .....	3-16
3.4.10	Min and Max VTE—Minimum and Maximum Exhalation Tidal Volume .....	3-16
3.4.11	Max Leak—Maximum Leakage .....	3-16
3.4.12	Max Rtot—Maximum Total Breath Rate .....	3-16
3.4.13	Min and Max FiO <sub>2</sub> —Minimum and Maximum Fraction of Inspired Oxygen .....	3-17
<b>3.5</b>	<b>V A/C Mode Parameters and Setting Ranges</b> .....	<b>3-17</b>
3.5.1	Vt—Tidal Volume .....	3-18
3.5.2	PEEP—Positive End Expiratory Pressure .....	3-18



## Table of Contents

3.5.3	Ramp Pattern—Flow Shape	3-19
3.5.4	Rate—Respiratory Rate	3-19
3.5.5	Insp Time—Inspiratory Time	3-19
3.5.6	I Sens—Inspiratory Trigger Sensitivity	3-19
3.5.7	Sigh Vt	3-19
3.5.8	Sigh Rate	3-20
3.5.9	Min and Max PIP—Minimum and Maximum Peak Inspiratory Pressure	3-20
3.5.10	Min and Max VTE—Minimum and Maximum Exhalation Tidal Volume	3-20
3.5.11	Max Rtot—Maximum Total Breath Rate	3-21
3.5.12	Min and Max FiO <sub>2</sub> —Minimum and Maximum Fraction of Inspired Oxygen	3-21
<b>3.6</b>	<b>P SIMV Mode Parameters and Setting Ranges</b>	<b>3-21</b>
3.6.1	Pi—Inspiratory Pressure	3-22
3.6.2	P Support—Pressure Support	3-23
3.6.3	PEEP—Positive End Expiratory Pressure	3-23
3.6.4	Rate—Respiratory Rate	3-23
3.6.5	Insp Time—Inspiratory Time	3-24
3.6.6	I Sens—Inspiratory Trigger Sensitivity	3-24
3.6.7	Apnea Time	3-24
3.6.8	Min and Max I Time—Minimum and Maximum Inspiration Time	3-24
3.6.9	Rise Time	3-25
3.6.10	E Sens—Exhalation Sensitivity	3-25
3.6.11	Min and Max VTI—Minimum and Maximum Inspiratory Tidal Volume	3-26
3.6.12	Min and Max VTE—Minimum and Maximum Exhalation Tidal Volume	3-26
3.6.13	Max Rtot—Maximum Total Breath Rate	3-26
3.6.14	Min and Max FiO <sub>2</sub> —Minimum and Maximum Fraction of Inspired Oxygen	3-26
<b>3.7</b>	<b>V SIMV Mode Parameters and Setting Ranges</b>	<b>3-27</b>
3.7.1	Vt—Tidal Volume	3-28
3.7.2	P Support—Pressure Support	3-29
3.7.3	PEEP—Positive End Expiratory Pressure	3-29
3.7.4	Rate—Respiratory Rate	3-29
3.7.5	Insp Time —Inspiratory Time	3-30
3.7.6	I Sens—Inspiratory Trigger Sensitivity	3-30
3.7.7	Apnea Time	3-30
3.7.8	Min and Max I Time—Minimum and Maximum Inspiration Time	3-31
3.7.9	Ramp	3-31
3.7.10	Rise Time	3-31
3.7.11	E Sens—Exhalation Sensitivity	3-31
3.7.12	Min and Max PIP—Minimum and Maximum Peak Inspiratory Pressure	3-32
3.7.13	Min and Max VTI—Minimum and Maximum Inspiratory Tidal Volume	3-32
3.7.14	Min and Max VTE—Minimum and Maximum Exhalation Tidal Volume	3-33
3.7.15	Max Rtot—Maximum Total Breath Rate	3-33
3.7.16	Min and Max FiO <sub>2</sub> —Minimum and Maximum Fraction of Inspired Oxygen	3-33
<b>3.8</b>	<b>FiO<sub>2</sub> For Various Oxygen and Ventilator Settings</b>	<b>3-34</b>

---

# Table of Contents

## 4 Monitored Parameters

4.1	<b>Overview</b>	4-1
4.2	<b>Digital Monitoring</b>	4-1
4.2.1	Menus	4-1
4.2.2	Inspiratory Trigger	4-5
4.2.3	Monitored Parameters Shown	4-6
4.3	<b>Bargraph Display</b>	4-7
4.4	<b>Waveform Display</b>	4-8
4.5	<b>Ventilation Report</b>	4-9

## 5 Alarms and Troubleshooting

5.1	<b>Overview</b>	5-1
5.2	<b>Alarm Level of Priority</b>	5-2
5.3	<b>Alarm Display</b>	5-2
5.4	<b>Alarm Logs Menu</b>	5-4
5.5	<b>Pausing the Audible Portion of Alarms</b>	5-5
5.6	<b>Pausing and Resetting Alarms</b>	5-6
5.7	<b>Reactivating Alarms</b>	5-7
5.8	<b>Overview of Alarms</b>	5-9
5.9	<b>Troubleshooting</b>	5-15
5.9.1	Alarms	5-15
5.9.2	Additional Troubleshooting	5-25

## 6 Installation and Assembly

6.1	<b>Ventilator Startup Procedure</b>	6-1
6.2	<b>Connecting to External AC Power</b>	6-3
6.3	<b>Connecting to an External DC Power Source</b>	6-6
6.4	<b>Patient Circuit</b>	6-9
6.4.1	Choosing the Patient Circuit Type	6-10
6.4.2	Installing the Patient Circuit	6-10
6.5	<b>Filters</b>	6-17
6.5.1	Air Inlet Filter	6-17
6.5.2	Bacteria Filter	6-18
6.6	<b>Humidifier</b>	6-18
6.7	<b>Exhalation Block</b>	6-20
6.8	<b>Oxygen</b>	6-21
6.8.1	Administering Oxygen	6-21
6.8.2	Connecting the Oxygen Supply	6-22
6.8.3	Connecting the FiO <sub>2</sub> Sensor	6-25
6.9	<b>Using the Dual Bag</b>	6-26
6.9.1	Fitting the Ventilator into the Dual Bag	6-26
6.9.2	Wearing the Dual Bag as a Backpack	6-27

---

## Table of Contents

6.9.3	Securing the Ventilator on a Wheelchair	6-27
6.9.4	Securing the Ventilator in a Personal Vehicle	6-29
<b>6.10</b>	<b>Mounting the Ventilator on a Utility Cart</b>	<b>6-30</b>
<b>6.11</b>	<b>Connecting the Nurse Call Cable</b>	<b>6-32</b>
<b>7</b>	<b>Operating Procedures</b>	
<b>7.1</b>	<b>Turning on the Ventilator</b>	<b>7-1</b>
<b>7.2</b>	<b>Setup Menu Parameters</b>	<b>7-5</b>
7.2.1	Accessing the Setup Menu	7-5
7.2.2	Changing the Setup Menu Parameters	7-5
7.2.3	Entering Setup 2 Menu	7-12
7.2.4	Exiting the Setup Menu	7-14
<b>7.3</b>	<b>Preferences Menu Parameters</b>	<b>7-14</b>
7.3.1	Accessing the Preferences Menu	7-15
7.3.2	Changing the Preferences Menu Parameters	7-15
7.3.3	Exiting the Preferences Menu	7-21
<b>7.4</b>	<b>Setting the Ventilation Mode</b>	<b>7-22</b>
7.4.1	Changing Modes While Ventilation is on Standby	7-22
7.4.2	Changing Modes During Ventilation	7-23
<b>7.5</b>	<b>Setting Ventilation Parameters</b>	<b>7-25</b>
7.5.1	Links Between Ventilation Parameters	7-26
7.5.2	Links Between Ventilation and Alarm Parameters	7-27
<b>7.6</b>	<b>Setting Alarm Parameters</b>	<b>7-27</b>
7.6.1	Blocking an Alarm Threshold Linked to a Ventilation Parameter	7-29
<b>7.7</b>	<b>USB Menu Parameters</b>	<b>7-30</b>
7.7.1	USB Memory Device Specifications	7-30
7.7.2	USB Memory Device Menu	7-30
<b>7.8</b>	<b>Locking the Control Panel</b>	<b>7-35</b>
<b>7.9</b>	<b>Unlocking the Control Panel</b>	<b>7-35</b>
<b>7.10</b>	<b>Starting Ventilation</b>	<b>7-36</b>
<b>7.11</b>	<b>Stopping Ventilation</b>	<b>7-37</b>
<b>7.12</b>	<b>Turning Off the Ventilator</b>	<b>7-38</b>
<b>8</b>	<b>Internal Battery</b>	
<b>8.1</b>	<b>Battery Capacity</b>	<b>8-2</b>
<b>8.2</b>	<b>Battery Operation</b>	<b>8-3</b>
<b>8.3</b>	<b>Testing the Battery</b>	<b>8-5</b>
<b>8.4</b>	<b>Recharging the Battery</b>	<b>8-5</b>
<b>8.5</b>	<b>Storage</b>	<b>8-6</b>

---

## Table of Contents

### 9 Cleaning

9.1	Cleaning the Ventilator	9-1
9.2	Cleaning the Accessories	9-2
9.3	Cleaning the Exhalation Block	9-2
9.4	Pneumatic System	9-3

### 10 Routine Maintenance

10.1	Overview	10-1
10.2	Expected Service Life	10-1
10.3	Calibrating the Exhalation Flow Sensor	10-2
10.4	Calibrating the FiO <sub>2</sub> Sensor	10-4
10.5	Replacing the Air Inlet Filter	10-6
10.6	Recommended Schedule of Maintenance	10-7
10.6.1	Preventive Maintenance Intervals	10-7
10.6.2	Maintenance of the Internal Battery	10-10
10.6.3	Periodic Test of the Internal Battery	10-10
10.6.4	Replacement of the Internal Battery	10-10
10.7	Service Assistance	10-11

### A Patient and Caregiver Checklist

A.1	Overview	A-1
A.2	What the Patient and Caregiver Must Understand	A-1
A.3	The Clinician's Responsibility	A-1

### B Specifications

B.1	Physical	B-1
B.2	Electrical	B-1
B.3	Indicators and Alarms	B-3
B.4	Performance	B-3
B.4.1	Specifications	B-3
B.4.2	Measurement Uncertainty	B-4
B.5	Monitored Parameters	B-4
B.6	Range, Resolution, and Accuracy	B-5
B.7	Environmental	B-9
B.8	USB	B-9
B.9	Pneumatic	B-10
B.10	Manufacturer's Declaration	B-11
B.11	Standards Compliance and IEC Classification	B-14
B.11.1	General Standards	B-14
B.11.2	Collateral Standards	B-14

---

## Table of Contents

B.11.3	Particular Standards	B-15
B.11.4	Air Transportation Standards	B-15
<b>C</b>	<b>Theory of Operation</b>	
<b>C.1</b>	<b>Architecture</b>	<b>C-1</b>
<b>C.2</b>	<b>Operation</b>	<b>C-1</b>
<b>D</b>	<b>Modes and Breath Types</b>	
<b>D.1</b>	<b>Modes of Ventilation</b>	<b>D-1</b>
D.1.1	Assist/Control (A/C) Modes	D-1
D.1.2	SIMV Modes	D-1
D.1.3	CPAP Mode	D-2
D.1.4	PSV Mode	D-2
<b>D.2</b>	<b>Breath Types</b>	<b>D-2</b>
D.2.1	Volume Breaths in Assist/Control Mode	D-2
D.2.2	Pressure Control Breaths in Assist/Control Mode	D-4
D.2.3	Volume Breaths in V SIMV Mode	D-5
D.2.4	Pressure Supported Breaths in SIMV and PSV Modes	D-8
D.2.5	CPAP	D-9
<b>D.3</b>	<b>Ventilation Modes and Apnea</b>	<b>D-10</b>
<b>E</b>	<b>Operational Verification Checklist</b>	
<b>F</b>	<b>Alarms Tests</b>	
<b>F.1</b>	<b>Low Pressure Test</b>	<b>F-2</b>
<b>F.2</b>	<b>Max Leak Test (Only NIV)</b>	<b>F-3</b>
<b>F.3</b>	<b>Circuit Check</b>	<b>F-4</b>
F.3.1	Accessing the Circuit Check Screen	F-4
F.3.2	Performing the Circuit Check	F-5
F.3.3	Troubleshooting a Failed Check	F-7
F.3.4	Returning to Ventilation Mode	F-7
<b>F.4</b>	<b>Apnea Test</b>	<b>F-7</b>
<b>F.5</b>	<b>Power Failure Test</b>	<b>F-8</b>
<b>F.6</b>	<b>Occlusion Test</b>	<b>F-9</b>
<b>F.7</b>	<b>High Pressure Test</b>	<b>F-10</b>
<b>F.8</b>	<b>Continuous Positive Pressure Alarm Test</b>	<b>F-12</b>
<b>F.9</b>	<b>Delivered Volume Alarm Test</b>	<b>F-13</b>
<b>F.10</b>	<b>High Expiratory Volume Alarm Test</b>	<b>F-14</b>
<b>F.11</b>	<b>Low Expiratory Volume Alarm Test</b>	<b>F-15</b>
<b>F.12</b>	<b>Battery Test</b>	<b>F-17</b>
<b>F.13</b>	<b>Involuntary Stop Test</b>	<b>F-18</b>

---

## Table of Contents

- G**      **Unpacking and Preparation**
- H**      **Parts and Accessories**
- I**      **Glossary**

## List of Figures

Figure 1-1.	Locations of Labels—Top-Front View . . . . .	1-25
Figure 1-2.	Locations of Labels—Front-Left View . . . . .	1-25
Figure 1-3.	Location of Labels and Markings—Rear View . . . . .	1-26
Figure 1-4.	Location of Labels—Bottom View . . . . .	1-26
Figure 2-1.	Front Panel . . . . .	2-4
Figure 2-2.	Back Panel . . . . .	2-5
Figure 2-3.	Control Panel . . . . .	2-6
Figure 2-4.	Ventilation Menu Display (on standby at left; during ventilation at right) . . . . .	2-7
Figure 2-5.	Alarm Menu (on standby at left; during ventilation at right) . . . . .	2-8
Figure 2-6.	Waveforms Menu . . . . .	2-9
Figure 2-7.	USB Memory Device Menu . . . . .	2-10
Figure 3-1.	Menus in PSV Mode with Exhalation Valve Configuration . . . . .	3-2
Figure 3-2.	Menus in PSV Mode with Leakage Configuration . . . . .	3-2
Figure 3-3.	Exhalation Trigger Sensitivity . . . . .	3-5
Figure 3-4.	Menus in CPAP Mode in leakage configuration . . . . .	3-9
Figure 3-5.	Menus in P A/C Mode with Exhalation Valve Configuration . . . . .	3-12
Figure 3-6.	Menus in P A/C Mode with Leakage Configuration . . . . .	3-12
Figure 3-7.	Menus in the V A/C Mode . . . . .	3-17
Figure 3-8.	Menus in P SIMV Ventilation Mode . . . . .	3-21
Figure 3-9.	Exhalation Trigger Sensitivity . . . . .	3-25
Figure 3-10.	Menus in V SIMV Ventilation Mode . . . . .	3-27
Figure 3-11.	Exhalation Trigger Sensitivity . . . . .	3-32
Figure 3-12.	Inhalation Flow (LPM) = Volume (L) x 60 / Inspiratory Time (S) . . . . .	3-34
Figure 4-1.	Ventilation Menu: Pressure Leakage Configuration Modes (CPAP, PSV S, PSV ST, PCV, P A/C) . . . . .	4-2
Figure 4-2.	Ventilation Menu: Pressure Valve Configuration Modes (PSV S, PSV ST, PCV, P A/C) . . . . .	4-2
Figure 4-3.	Ventilation Menu: Volume Mode (CV, V A/C, SIMV) . . . . .	4-2
Figure 4-4.	Alarm Menu: Pressure Leakage Modes (CPAP, PSV S, PSV ST, PCV, P A/C) . . . . .	4-3
Figure 4-5.	Alarm Menu: Pressure Valve Modes (PSV S, PSV ST, PCV, P A/C) . . . . .	4-3
Figure 4-6.	Alarm Menu: Volume Modes (CV, V A/C, SIMV) . . . . .	4-3
Figure 4-7.	Waveform Menu: Pressure Leakage Modes (CPAP, PSV S, PSV ST, PCV, P A/C) . . . . .	4-4
Figure 4-8.	Waveform Menu: Pressure Valve Modes (PSV S, PSV ST, PCV, P A/C) . . . . .	4-4
Figure 4-9.	Waveform Menu: Volume Mode (CV, V A/C, SIMV) . . . . .	4-4
Figure 4-10.	Monitored Parameter Inserts . . . . .	4-5
Figure 4-11.	Display Showing Unavailable Parameter Values . . . . .	4-5
Figure 4-12.	Inspiratory Effort Detected Indicator . . . . .	4-6
Figure 4-13.	Bargraph Display . . . . .	4-7
Figure 4-14.	Waveform Screen . . . . .	4-8
Figure 4-15.	Ventilation Report . . . . .	4-9
Figure 5-1.	Front Panel (Alarm Control Key) . . . . .	5-3
Figure 5-2.	Alarm Messages (in Ventilation menu at left, in Alarm menu at right) . . . . .	5-3
Figure 5-3.	Accessing the Alarm Logs Menu . . . . .	5-4
Figure 5-4.	Alarm Logs Screen . . . . .	5-4

---

## List of Figures

Figure 5-5.	Alarm Logs Screen (no alarm activated).....	5-5
Figure 5-6.	Pausing the Audible Portion of Alarms.....	5-6
Figure 5-7.	Ventilator Screen (alarm paused indicator).....	5-7
Figure 5-8.	Reactivating Alarms.....	5-7
Figure 5-9.	Alarm Logs.....	5-8
Figure 6-1.	The Power Cable Holder.....	6-4
Figure 6-2.	Inserting the Power Cable Holder into the Notch.....	6-4
Figure 6-3.	Power Cable Connected to the Ventilator.....	6-5
Figure 6-4.	Power Indicators.....	6-6
Figure 6-5.	Connecting the DC Power Cable to the Ventilator.....	6-7
Figure 6-6.	Connecting the Ventilator to an External DC Power Source.....	6-8
Figure 6-7.	Single-Limb Patient Circuit With Exhalation Valve (including accessories).....	6-11
Figure 6-8.	Closeup of Exhalation Valve Tube and Proximal Pressure Tube.....	6-12
Figure 6-9.	Double-Limb Patient Circuit (including accessories).....	6-13
Figure 6-10.	Closeup of Exhalation Valve Tube and Proximal Pressure Tube.....	6-14
Figure 6-11.	Close-up of Exhalation Bacteria Filter Connection.....	6-15
Figure 6-12.	Single-Limb Patient Circuit Without Exhalation Valve (including accessories).....	6-15
Figure 6-13.	Air Inlet Filter.....	6-17
Figure 6-14.	Bacteria Filter.....	6-18
Figure 6-15.	Humidifier.....	6-18
Figure 6-16.	Removing the Exhalation Block.....	6-20
Figure 6-17.	Rear Panel Oxygen Inlet Port and Coupler.....	6-22
Figure 6-18.	Connecting the Oxygen Supply.....	6-23
Figure 6-19.	Disconnecting the Oxygen Supply.....	6-24
Figure 6-20.	Connecting the FiO <sub>2</sub> Sensor.....	6-25
Figure 6-21.	Using the Dual Bag as a Backpack.....	6-27
Figure 6-22.	Using the Dual Bag on a Wheelchair (with double-limb circuit on left; with single-limb circuit on right).....	6-28
Figure 6-23.	Using the Dual Bag in a Personal Vehicle.....	6-29
Figure 6-24.	Mounting the Ventilator on the Utility Cart.....	6-30
Figure 6-25.	Securing the Ventilator on the Utility Cart.....	6-30
Figure 6-26.	Puritan Bennett™ 560 Ventilator Mounted on Utility Cart.....	6-31
Figure 6-27.	Connecting the Nurse Call Cable.....	6-32
Figure 7-1.	Turning on the Ventilator.....	7-3
Figure 7-2.	VENTILATION ON/OFF Button and Standby Indicator.....	7-3
Figure 7-3.	Welcome Menu Screen.....	7-4
Figure 7-4.	Ventilation Menu Parameters.....	7-4
Figure 7-5.	Setup Menu.....	7-5
Figure 7-6.	Resetting Patient Hours to Zero (1).....	7-8
Figure 7-7.	Resetting Patient Hours to Zero (2).....	7-9
Figure 7-8.	Resetting Patient Hours to Zero (3).....	7-9
Figure 7-9.	Resetting Patient Hours to Zero (4).....	7-10
Figure 7-10.	Restoring Default Settings (1).....	7-10



---

## List of Figures

Figure 7-11.	Restoring Default Settings (2) .....	7-11
Figure 7-12.	Restoring Default Settings (3) .....	7-11
Figure 7-13.	Setup 2 Menu .....	7-12
Figure 7-14.	Absolute and Relative Pressure .....	7-13
Figure 7-15.	E Sens Settings .....	7-14
Figure 7-16.	Selecting the Preferences Menu .....	7-15
Figure 7-17.	Changing Settings in the Preferences Menu (1) .....	7-15
Figure 7-18.	Changing Settings in the Preferences Menu (1) .....	7-16
Figure 7-19.	Increasing Contrast .....	7-17
Figure 7-20.	Decreasing Contrast .....	7-17
Figure 7-21.	Increasing Alarm Volume .....	7-18
Figure 7-22.	Decreasing Alarm Volume .....	7-18
Figure 7-23.	Setting the Apnea Alarm .....	7-19
Figure 7-24.	Accessing the Ventilation Report .....	7-21
Figure 7-25.	Changing Ventilation Modes While on Standby .....	7-22
Figure 7-26.	Changing Ventilation Modes During Ventilation (1) .....	7-23
Figure 7-27.	Changing Ventilation Modes During Ventilation (2) .....	7-24
Figure 7-28.	Changing Ventilation Modes During Ventilation (3) .....	7-24
Figure 7-29.	Changing Ventilation Modes During Ventilation (4) .....	7-25
Figure 7-30.	Modifying a Ventilation Parameter .....	7-26
Figure 7-31.	Setting Links Between Ventilation Parameters .....	7-27
Figure 7-32.	Modifying Alarm Parameters—Min Value .....	7-28
Figure 7-33.	Modifying Alarm Parameters—Max Value .....	7-28
Figure 7-34.	Selecting the USB Menu .....	7-30
Figure 7-35.	Selecting Transfer Continuously .....	7-31
Figure 7-36.	Selecting Transfer Trends .....	7-32
Figure 7-37.	Erasing Data from the USB Memory Device .....	7-34
Figure 7-38.	Installing the Locking Key .....	7-35
Figure 7-39.	Prompt to Start Ventilation .....	7-36
Figure 7-40.	Starting Ventilation .....	7-37
Figure 7-41.	Stopping Ventilation (1) .....	7-37
Figure 7-42.	Stopping Ventilation (2) .....	7-38
Figure 8-1.	Internal Battery Indicator .....	8-3
Figure 8-2.	Battery Reserve Capacity as a Percentage .....	8-4
Figure 8-3.	Battery Reserve Capacity in Hours and Minutes .....	8-4
Figure 8-4.	Power Indicators When Charging the Battery .....	8-5
Figure 9-1.	Puritan Bennett™ 560 Ventilator Pneumatic Diagram .....	9-3
Figure 10-1.	Blocking the Patient Circuit (single-limb circuit at left; double-limb circuit at right) .....	10-2
Figure 10-2.	Calibrating the Exhalation Flow Sensor (1) .....	10-3
Figure 10-3.	Calibrating the Exhalation Flow Sensor (2) .....	10-3
Figure 10-4.	Calibrating the Exhalation Flow Sensor (3) .....	10-3
Figure 10-5.	Calibrating the FiO2 Sensor (1) .....	10-5
Figure 10-6.	Calibrating the FiO2 Sensor (2) .....	10-5

---

## List of Figures

Figure 10-7.	Calibrating the FiO <sub>2</sub> Sensor (3).....	10-6
Figure 10-8.	Replacing the Air Inlet Filter .....	10-7
Figure D-1.	Waveforms (Volume Breaths in A/C Mode).....	D-3
Figure D-2.	A/C Mode Breaths .....	D-4
Figure D-3.	Waveforms (Pressure Control Breaths in A/C Mode) .....	D-4
Figure D-4.	P A/C Mode Breaths .....	D-5
Figure D-5.	Waveforms (Volume Breaths in V SIMV Mode).....	D-6
Figure D-6.	V SIMV Mode Breaths .....	D-7
Figure D-7.	Waveforms (Pressure Supported Breaths in SIMV and PSV Modes).....	D-8
Figure D-8.	Waveforms (CPAP).....	D-9
Figure F-1.	Ventilator Screen (Patient Disconnection alarm shown) .....	F-2
Figure F-2.	Ventilator Screen (High Leakage alarm shown).....	F-3
Figure F-3.	Circuit Check Screen (before starting).....	F-4
Figure F-4.	Blocking the Patient Circuit (single-limb circuit at left; double-limb circuit at right) .....	F-5
Figure F-5.	Circuit Check (running) .....	F-5
Figure F-6.	Circuit Check (complete, passed) .....	F-6
Figure F-7.	Circuit Check (complete, failed) .....	F-6
Figure F-8.	Ventilator Screen (Apnea alarm shown).....	F-8
Figure F-9.	Ventilator Screen (AC Power Disconnection alarm shown) .....	F-9
Figure F-10.	Blocking the Patient Circuit (single-limb circuit at left; double-limb circuit at right) .....	F-9
Figure F-11.	Ventilator Screen (Occlusion alarm shown) .....	F-10
Figure F-12.	Ventilator Screen (High Pressure alarm shown).....	F-11
Figure F-13.	Ventilator Screen (Proximal Sensor Fault 2 alarm shown) .....	F-13
Figure F-14.	Ventilator Screen (Low VTI alarm shown).....	F-14
Figure F-15.	Ventilator Screen (High VTE alarm shown) .....	F-15
Figure F-16.	Ventilator Screen (Low VTE alarm shown).....	F-16
Figure F-17.	Ventilator Screen (AC Power Disconnection alarm shown) .....	F-17

---

## List of Tables

Table 1-1.	Ventilator Symbols .....	1-19
Table 1-2.	Ventilator Labels and Markings .....	1-24
Table 3-1.	Ventilation Parameters in PSV Menu .....	3-2
Table 3-2.	Alarm Parameters in PSV Mode .....	3-3
Table 3-3.	Ventilation Parameters in CPAP Menu.....	3-9
Table 3-4.	Alarm Parameters in CPAP Mode .....	3-9
Table 3-5.	Ventilation Parameters in PA/C Mode Menu .....	3-12
Table 3-6.	Alarm Parameters in PA/C Mode.....	3-13
Table 3-7.	Ventilation Parameters in V A/C Ventilation Mode.....	3-17
Table 3-8.	V A/C Mode Alarm Parameters.....	3-18
Table 3-9.	Ventilation Parameters in P SIMV Ventilation Mode.....	3-22
Table 3-10.	Alarm Parameters in P SIMV Ventilation Mode.....	3-22
Table 3-11.	Ventilation Parameters in V SIMV Mode .....	3-27
Table 3-12.	Alarm Parameters in the V SIMV Mode Menu.....	3-28
Table 4-1.	Monitored Parameters Shown .....	4-6
Table 5-1.	Overview of Alarms.....	5-9
Table 5-2.	Alarms and Corrective Actions.....	5-15
Table 5-3.	Additional Troubleshooting and Corrective Actions.....	5-25
Table 7-1.	Languages .....	7-7
Table 7-2.	USB Memory Device Specifications .....	7-30
Table 7-3.	Ventilator to USB Device Data Transfer Times .....	7-33
Table 8-1.	Internal Battery Reserve Capacity .....	8-2
Table 9-1.	Approved Cleaning Solutions for Exterior Ventilator Surfaces.....	9-2
Table 10-1.	Preventive Maintenance Schedule.....	10-8
Table A-1.	Patient and Caregiver Checklist.....	A-1
Table B-1.	Physical Description (excluding accessories) .....	B-1
Table B-2.	Electrical Supply.....	B-1
Table B-3.	Internal Lithium Ion Battery.....	B-2
Table B-4.	Remote Alarm.....	B-2
Table B-5.	Power Indicators .....	B-3
Table B-6.	Alarm Indicators.....	B-3
Table B-7.	Audio Alarms.....	B-3
Table B-8.	Performance Parameter Specifications and Tolerances.....	B-3
Table B-9.	Performance Verification Equipment Uncertainty .....	B-4
Table B-10.	Monitored Parameter Tolerances .....	B-4
Table B-11.	Ventilator Range, Resolution, and Accuracy .....	B-5
Table B-12.	Environmental Conditions for Storage or Transport .....	B-9
Table B-13.	Environmental Conditions for Operation.....	B-9
Table B-14.	USB Memory Device Specifications .....	B-9
Table B-15.	Data Transfer Characteristics.....	B-9
Table B-16.	Airway Resistances .....	B-10
Table B-17.	Patient Circuit Resistances.....	B-10
Table B-18.	Air Inlet Resistance (Filter) .....	B-10

---

## List of Tables

Table B-19.	Oxygen Inlet Specifications .....	B-10
Table B-20.	Performance Specifications .....	B-10
Table B-21.	Electromagnetic Emissions .....	B-12
Table B-22.	Electromagnetic Immunity .....	B-12
Table B-23.	Electromagnetic Immunity—Conducted and Radiated RF .....	B-13
Table B-24.	Compliant Cables and Accessories.....	B-13
Table E-1.	Operational Verification Checklist.....	E-1
Table G-1.	Items Included with Ventilator .....	G-1
Table H-1.	List of Consumables and Accessories .....	H-1
Table H-2.	List of Circuits .....	H-2

# Preface

## Purpose of This Manual

This manual contains important information regarding the safe operation of your Puritan Bennett™ 560 ventilator. Your ventilator is an electrical device that can provide years of useful service with the proper care, as described in this manual.

Ensure that you read and understand the instructions contained in this manual before operating the ventilator.



### **WARNING:**

**Before operating the ventilator, read, understand, and strictly follow the information contained in Chapter 1, *Safety Information*.**

## Qualification of Personnel

Installation and maintenance of the device must be made by authorized and trained personnel. In particular, training for the handling of products sensitive to electrostatic discharges must include the use of electrostatic discharge (ESD) protection devices and knowledge of the meaning of the symbol at left, as well as using original spare parts and respecting quality assurance and traceability rules approved by Covidien.



## Warranty

Information regarding your product warranty is available from your sales representative or Covidien.

## Extended Service

The Puritan Bennett™ 560 ventilator offers extended service contracts/warranties for purchase when the ventilator is purchased. Please contact your local Covidien sales or service representative for additional information.



For online technical support, visit the SolvIT<sup>SM</sup> Center Knowledge Base by clicking the link at [www.medtronic.com/covidien/support/solvit-center-knowledge-base/](http://www.medtronic.com/covidien/support/solvit-center-knowledge-base/). Here, you will find answers to frequently asked questions about the product and other Covidien products 24 hours a day, 7 days a week. If you require further assistance, contact your local Covidien representative.

## Service Centers

<p><b>Covidien Argentina</b> Pacheco Trade Center Marcos Sastre 1990, El Talar, Buenos Aires, Argentina, B1610CRH [T] +54 01157898107 [F] +54 114863 4142</p>	<p><b>Covidien Asia</b> Singapore Regional Service Centre 15 Pioneer Hub, #06-04 Singapore 627753 [T] +65 6578 5288 [F] +65 6515 5260</p>	<p><b>Covidien Australia</b> 52A Huntingwood Drive Huntingwood, NSW 2148 Australia [T] +61 1800 350702 [F] +61 2967 18118</p>	<p><b>Covidien Austria GmbH</b> C-Mill Gebouw K Jan Campertstraat 21-A 6416 SG Heerlen, Netherlands [T] 01 20609 1143 [F] 01 20609 2457 [E] techservices.csAustria@ medtronic.com</p>
<p><b>Covidien Belgium BVBA/SPRL</b> C-Mill Gebouw K Jan Campertstraat 21-A 6416 SG Heerlen, Netherlands [T] 0220 08260 [F] 0270 06690 [E]techservices.csBel- gium@medtronic.com</p>	<p><b>Covidien Brazil</b> Av. Das Nações Unidas 12995 Andar 23 - Brooklin São Paulo, SP Brasil 04578-000 [T] +5511 2187 6200 [F] +5511 2187 6380</p>	<p><b>Covidien Canada</b> 19600 Clark Graham Baie d'Urfe, QC, H9X 3R8 Canada [T] 514 695 1220 (ext 4004) [F] 514 695 4965</p>	<p><b>Covidien Chile</b> Camino lo Boza (Ex 8395) Pude- huel Santiago Chile [T] +562 739 3000 [F] +562 783 3149</p>
<p><b>Covidien China</b> 2F, Tyco Plaza 99 Tian Zhou Rd Shang Hai 200233 P.R. China [T] +86 4008 1886 86 [F] +86 2154 4511 18</p>	<p><b>Covidien Colombia</b> Avenida Calle 116 # 7-15 / Oficina 1101 Torre Cusezar, Bogotá, Colombia [T] +57 1 7427300 [F] +571 619 5425</p>	<p><b>Covidien Costa Rica</b> Global Park, Parkway 50 La Aurora de Heredia Costa Rica [T] +506 2239 5386 [F] +506 2239 5319</p>	<p><b>Covidien ECE</b> Organizační Složka Prosecká 852/66 190 00 Praha 9 Czech Republic [T] +420 241 095 735 [F] +420 239 016 856</p>
<p><b>Covidien Danmark A/S</b> C-Mill Gebouw K Jan Campertstraat 21-A 6416 SG Heerlen, Netherlands [T] +45 43 68 21 71 [F] +45 43 31 48 99 [E]techservices.csDenmark@ medtronic.com</p>	<p><b>Covidien Deutschland GmbH</b> C-Mill Gebouw K Jan Campertstraat 21-A 6416 SG Heerlen, Netherlands [T] +49 6951709670 [F] +49 69299571608 [E] techservices.csGermany@ medtronic.com</p>	<p><b>Covidien ECE</b> Galvahiho 7 / A 832104 Bratislava Slovakia [T] +421 2 4821 4573 [F] +421 2 4821 4501</p>	<p><b>Covidien Finland OY</b> C-Mill Gebouw K Jan Campertstraat 21-A 6416 SG Heerlen, Netherlands [T] +358 972519288 [F] +358 972522072 [E] techservices.csFinland@ medtronic.com</p>

<p><b>Covidien France SAS</b> C-Mill Gebouw K Jan Campertstraat 21-A 6416 SG Heerlen, Netherlands [T] +33 151 323 510 [F] +33 157 327 010 [E] techservices.csFrance@medtronic.com</p>	<p><b>Covidien Hong Kong</b> Unit 12 - 16, 18/F BEA Tower Millennium City 5 4187 Kwun Tong Road Kwum Tong, Kowloon, Hong Kong [T] +852 3157 7299 [F] +852 2838 0749</p>	<p><b>Covidien ECE s.r.o.</b> Magyarországi Fióktelepe Mariássy u.7. 1095 Budapest Hungary [T] +36 1 880 7975 [F] +36 1 778 9459</p>	<p><b>Covidien India</b> 10th Floor Building No 9B DLF Cyber City Phase III Gurgaon Haryana - 122002 India [T] +91 1 244 709800 [F] +91 1 244 206850</p>
<p><b>Covidien Ireland</b> C-Mill Gebouw K Jan Campertstraat 21-A 6416 SG Heerlen, Netherlands [T] +353 0 1 4073173 [F] +353 0 1 9075668 [E] techservices.csireland@medtronic.com</p>	<p><b>Covidien Israel</b> 3 HaCarmel Street, Kochav Yokneam Building Yokneam Elit Israel 20692 [T] +972 4 6309423 [F] +97 2774704093 [E] service.repair.israel@medtronic.com</p>	<p><b>Covidien Italia S.p.A</b> C-Mill Gebouw K Jan Campertstraat 21-A 6416 SG Heerlen, Netherlands [T] +39 02 91 483320 [F] +39 02 91 294863 [E] techservices.csitaly@medtronic.com</p>	<p><b>Covidien Japan Inc.</b> Technical Support Center 83-1, Takashimadaira 1-Chome Itabashi-ku, Tokyo 175-0082 Japan [T] +81 0 3 6859 0120 [F] +81 0 3 6859 0142</p>
<p><b>Covidien Korea</b> 5F, Hibrand Living Gwan, #215, Yangjae-Dong, Seocho-Gu Seoul, Korea [T] +822 570 5459 [F] +822 570 5499</p>	<p><b>Covidien Mexico</b> Autopista México-Querétaro KM 34.5 Nave 3 Cortina 113 Cuautitlán Izcalli 54740 México, Estado de México [T] 5255 5804 1524 (ext. 1410) [F] 5255 5536 1326</p>	<p><b>Covidien Nederland BV</b> C-Mill Gebouw K Jan Campertstraat 21-A 6416 SG Heerlen, Netherlands [T] +31 202061470 [F] +31 707709229 [E] techservices.csitaly@medtronic.com</p>	<p><b>Covidien New Zealand</b> Cnr Manu Tapu Dr &amp; Joseph Hammond Pl. Auckland Airport New Zealand [T] +64 508 489 264</p>
<p><b>Covidien Norge AS</b> C-Mill Gebouw K Jan Campertstraat 21-A 6416 SG Heerlen, Netherlands [T] +47 24159887 [F] +47 23024955 [E] techservices.csNorway@medtronic.com</p>	<p><b>Covidien Panama</b> Parque Industrial Costa del Esta Calle Primera, Edificio # 109 Panama City, Panama [T] +507 264 7337 [F] +507 236 7408</p>	<p><b>Covidien Polska</b> C-Mill Gebouw K Jan Campertstraat 21-A 6416 SG Heerlen, Netherlands [T] +48 223060034 [F] +48 223060853 [E] techservices.csPoland@medtronic.com</p>	<p><b>Covidien Portugal Lda.</b> C-Mill Gebouw K Jan Campertstraat 21-A 6416 SG Heerlen, Netherlands [T] +351 21 761 62 44 [F] +351 800 781385 [E] techservices.csPortugal@medtronic.com</p>
<p><b>Covidien Puerto Rico</b> Palmas Industrial Park Road 869 Km 2.0 Bdlg. #1 Cataño, PR 00962 [T] 787 993 7250 (ext. 7221/22) [F] 787 993 7234</p>	<p><b>Covidien Russia</b> Tupikovy proezd, Building 1, Marushinsky, Krekshino village Moscow, Russia [T] +7 495 995 1898 [F] +7 495 933 6468 [E] service.repair.russia@medtronic.com</p>	<p><b>Covidien Saglik A.S.</b> LTD.ŞTI Akçaburgaz Mah. 1567 Sok. No.2 DHL Depolama Tesisleri Esenyurt Istanbul, Turkey [T] +90 212 6223 500 [F] +90 212 6720 722 [E] service.repair.turkey@medtronic.com</p>	<p><b>Covidien South Africa</b> Waterfall Distribution Campus Cnr Bridal Veil Road &amp; K101 Pre- toria Main Road Midrand South Africa 1685 [T] +27 11 542 9584 [F] +27 86 604 8360 [E]service.repair.southafri- ca@medtronic.com</p>




<p><b>Covidien Spain S.L.</b>                  C-Mill Gebouw K                  Jan Campertstraat 21-A                  6416 SG Heerlen, Netherlands                  [T] +34 91 275 48 54                  [F] +34 91 276 89 33                  [E] techservices.csSpain@medtronic.com</p>	<p><b>Covidien Sverige AB</b>                  C-Mill Gebouw K                  Jan Campertstraat 21-A                  6416 SG Heerlen, Netherlands                  [T] +46 8517 61573                  [F] +46 8502 52110                  [E] techservices.csSweden@medtronic.com</p>	<p><b>Covidien Switzerland</b>                  C-Mill Gebouw K                  Jan Campertstraat 21-A                  6416 SG Heerlen, Netherlands                  [T] +41 44 511 82 71                  [F] +41 44 511 16 34                  [E] techservices.csSwitzerland@medtronic.com</p>	<p><b>Covidien Thailand</b>                  99 Soi Rubia                  Sukhumvit 42 Road                  13-14 Fl., Berli Jucker Building                  Prakanong, Klongtoey                  Bangkok 10110, Thailand                  [T] +66 2 207 3100                  [F] +66 2 657 6325</p>
<p><b>Covidien UK</b>                  C-Mill Gebouw K                  Jan Campertstraat 21-A                  6416 SG Heerlen, Netherlands                  [T] +44 0 2030271757                  [F] +44 0 2036848869                  [E] techservices.csUK@medtronic.com</p>			



# 1 Safety Information

## 1.1 Definitions

This manual uses three indicators to highlight critical information: warning, caution, and note. They are defined as follows:

	<b>WARNING</b> Indicates a condition that can endanger the patient or the ventilator operator.
	<b>Caution</b> Indicates a condition that can damage the equipment.
	<b>Note</b> Indicates points of particular emphasis, that make operation of the ventilator more efficient or convenient.

It is essential to read, understand and follow these instructions before using the Puritan Bennett™ 560 ventilator.

In order to use the ventilator correctly and efficiently and to help prevent incidents, please pay particular attention to section [1.2, Warnings](#), as well as all warnings and cautions contained throughout this manual.

## 1.2 Warnings

### 1.2.1 General Warnings Regarding Use of Equipment



**WARNING:**

The ventilator must be used only under the responsibility and on the prescription of a doctor.



**WARNING:**

The ventilator must be used according to its intended use. Refer to section [2.1, Indications for Use](#).



**WARNING:**

Be aware this manual describes how to respond to the ventilator, but does not tell you how to respond to the patient.



**WARNING:**

While the ventilator is in use, an alternative means of ventilation should always be available in the event of a ventilator problem. This is particularly true for ventilator-dependent patients. Supplementary observation, appropriate for the patient's condition, is also recommended.



**WARNING:**

To ensure that ventilation continues uninterrupted, ensure alternative power sources are available (AC power source, extra batteries, or an auxiliary DC car adapter). Be prepared for the possibility of power failure by having an alternative means of ventilation ready for use – particularly for ventilator-dependent patients.



**WARNING:**

Do not allow a patient to remain connected to the ventilator when ventilation is stopped, because a substantial quantity of exhalation gas, primarily carbon dioxide, may be inhaled by the patient. In some circumstances, inhaling carbon dioxide may lead to under-ventilation, suffocation, and serious injury or death.



**WARNING:**

Always have immediate access to an alternative means of ventilation, which is ready for use, to avoid patient death or serious injury.



**WARNING:**

The ventilator must not be used with flammable anesthetic substances.



**WARNING:**

Do not start ventilation until you ensure that the device is suitably assembled, that the air inlet filter is properly installed and is not obstructed, and that there is proper clearance all around the unit. Also ensure that the patient circuit is suitably connected to both the ventilator and the patient and that the patient circuit, including all hoses, is not damaged or obstructed.



**WARNING:**

A ventilator-dependent patient should always be monitored by trained and competent medical personnel. Ensure that the patient's caregiver is able and prepared to take suitable action in the event the ventilator identifies an alarmed condition or experiences a problem.



**WARNING:**


Do not use a patient circuit with a leak accessory for ventilator-dependent patients.



**WARNING:**

Refer to this manual for equipment compatible with this ventilator. It may be unsafe to interconnect this equipment with other equipment not described in this manual.

**WARNING:**

Before dispensing the ventilator to caregivers or the patient for home use, ensure the Locking Key  is activated so that critical ventilator settings are not modified.

**WARNING:**

Do not perform ventilator alarm tests while the patient is connected to the ventilator. Provide the patient with an alternate means of ventilation before conducting these tests.

**WARNING:**

Verify the functionality of the alarms before connecting the patient to the ventilator. Refer to Appendix [F, Alarms Tests](#).

**WARNING:**

If the ventilator fails the alarm tests or if you cannot complete the tests, refer to section [5.9, Troubleshooting](#) or call your equipment supplier or Covidien.

**WARNING:**

When an alarm condition is triggered, or there is evidence of a patient-ventilator fault or problem, examine the patient first before examining the ventilator.

**WARNING:**

A continuous alarm condition will be activated if the ventilator power switch is turned off while ventilation is in progress. When the power switch is turned back on again, ventilation will resume without having to press the VENTILATION ON/OFF button.

**WARNING:**

To reduce the risk of infection, wash your hands thoroughly before and after handling the ventilator or its accessories.

**WARNING:**

A patient treated by mechanical ventilation is highly vulnerable to the risks of infection. Dirty or contaminated equipment is a potential source of infection. Clean the ventilator and its accessories regularly and systematically before and after each use and following any maintenance procedure to reduce the risks of infection. The use of a bacterial filter at the ventilator's outlet (TO PATIENT) port—or both ports if a double-limb circuit is used—is recommended. Refer to Chapter [9, Cleaning](#).

**WARNING:**

Handle the ventilator with care during and after use, particularly when ambient temperatures are high. Some ventilator surfaces may become hot, even if safety specifications are not exceeded.

**WARNING:**

Do not connect the ventilator to any device other than a PC with a dedicated compatible Puritan Bennett™ software package.

**WARNING:**

The ventilator system is not intended to be a comprehensive monitoring device and does not activate alarms for all types of conditions. For a detailed understanding of ventilator operations, be sure to thoroughly read this manual before attempting to use the ventilator system.

**1.2.2 Warnings Regarding Installation and Environment of Use****WARNING:**

Even though the Puritan Bennett™ 560 ventilator meets current safety standards, the internal Lithium-ion battery of the device exceeds the 100Wh threshold and is therefore considered to be Dangerous Goods (DG) Class 9 – Miscellaneous, when transported in commerce. As such, the Puritan Bennett™ 560 ventilator and/or the associated Lithium-ion battery are subject to strict transport conditions under the Dangerous Goods Regulation for air transport (IATA: International Air Transport Association), International Maritime Dangerous Goods code for sea and the European Agreement concerning the International Carriage of Dangerous Goods by Road (ADR) for Europe. Private individuals who transport the device are excluded from these regulations although for air transport some requirements apply. For air transport; the Puritan Bennett™ 560 ventilator is permitted as checked-in or carry-on baggage. Two spare batteries per person may be taken on board as carry-on luggage only, with the prior approval of the airline. This classification and regulatory requirements may vary depending upon the country and mode of transport. Therefore it is recommended that users verify with the carrier / airline as to which measures to take before the voyage.

**WARNING:**

To minimize the risk of damage, you must use the ventilator's dual bag to transport the ventilator. Ventilator accessories are listed in [Table H-1](#).

**WARNING:**

When using the ventilator in a carrying case, only use a carrying case that is listed in the instructions for use to prevent adverse ventilator performance, which can consequently result in patient death.

**WARNING:**

Regularly clean the ventilator's dual bag according to manufacturer's recommendations.

**WARNING:**

The ventilator should never be immersed in any liquid, and any liquid on the surface of the device should be wiped away immediately.

**WARNING:**

To avoid damage to the ventilator, in particular the batteries or electrical components, fluids must not be allowed to enter the device, particularly through the air inlet filter or the cooling apertures located in the side, rear, and bottom panels of the ventilator.

**WARNING:**

To ensure correct and lasting operation of the device, ensure that the ventilator is installed and operated in the environmental conditions recommended in Appendix *B, Specifications*.

**WARNING:**

Do not leave power cables lying on the ground where they may pose a hazard.

**WARNING:**

Do not operate the ventilator in a magnetic resonance imaging (MRI) environment. Doing so could cause a ventilator malfunction.

**WARNING:**

Do not operate the ventilator in the presence of active high frequency (HF) surgical equipment. Doing so could cause a ventilator malfunction.

**WARNING:**

Do not operate the ventilator in direct sunlight, near heat sources, outdoors, or near installations where liquid may pose a risk without first providing adequate protection for the device.

**WARNING:**

Avoid using the ventilator, if possible, in dusty environments. Dusty environments may require more vigilant monitoring, cleaning, and/or replacement of air intake and other filters.

**WARNING:**

Ensure that the ventilator's immediate surroundings allow for the proper operational connection of the device without folding, pinching, or damaging any of the required cables or tubes, and that the connection of the patient circuit to the patient provides for a secure, comfortable fit.

**WARNING:**

Ensure that the ventilator is not positioned or located such that the AC and DC connections at the back of the ventilator are difficult to access.

**WARNING:**

Do not cover the ventilator or place in a position that affects proper operation, e.g., blocking a front or lateral opening.

**WARNING:**

Place the ventilator in a safe place when ventilating and according to the recommendations in this manual.

**WARNING:**

Do not place the ventilator in a position where a child, pet or pest can reach it, or in any position that might cause it to fall on the patient or someone else.



**WARNING:**

To ensure correct and lasting operation of the ventilator, ensure that its air circulation holes (main inlet or cooling) are never obstructed. Place the device in an area where air can freely circulate around the ventilator and avoid installing it near floating fabrics, such as curtains.



**WARNING:**

If the ventilator has been transported or stored at a temperature that differs more than  $\pm 20^{\circ}\text{C}$  ( $\pm 36^{\circ}\text{F}$ ) from the temperature in which it will be operating, the ventilator should be allowed to stabilize in its operating environment for at least 2 hours prior to use. When the ambient temperature is  $20^{\circ}\text{C}$ , 2 hours are required to warm the ventilator from the minimum storage temperature or to cool the ventilator from the maximum storage temperature prior to use.



**WARNING:**

If the ambient temperature where the device is operated is greater than  $35^{\circ}\text{C}$  ( $95^{\circ}\text{F}$ ), the temperature of the patient circuit or the flow supplied at the device outlet may exceed  $41^{\circ}\text{C}$  ( $106^{\circ}\text{F}$ ), and the patient circuit may reach up to  $60^{\circ}\text{C}$  ( $140^{\circ}\text{F}$ ). This may lead to undesirable side effects for the patient. To avoid injury to the patient move the patient and the ventilator to a cooler location. For more information, contact Covidien.



**WARNING:**

The default setting for altitude compensation is YES. Altitude compensation should always be set to YES for accurate volume delivery calculations at all elevations.



**WARNING:**

To reduce the risk of a fire hazard, keep matches, lighted cigarettes, and all other sources of ignition (such as flammable anesthetics and/or heaters) away from the ventilator and oxygen hoses.



**WARNING:**

Regularly check the cleanliness of the air inlet filter located on the rear of the ventilator. If necessary, replace the filter before the recommended replacement period is over (see Chapter 10, *Routine Maintenance*). This is particularly important when the ventilator is installed on a wheelchair, because environmental conditions may cause the filter to become dirty more rapidly.



**WARNING:**

Handle the ventilator with care during and after use, particularly when ambient temperatures are high. Some ventilator surfaces may become hot, even if safety specifications are not exceeded.



**WARNING:**

Exercise care to avoid any potential significant risks of reciprocal interference posed by the ventilator and accessories during specific investigations or treatments.

### 1.2.3 Warnings Regarding Electrical Power Supplies



**WARNING:**

The operator should connect the ventilator to an AC power source whenever available, for safer operation.



**WARNING:**

The maximum recommended shelf life of the internal battery is 2 years. Do not use a battery that has been stored for 2 years prior to its first use.



**WARNING:**

Periodic recharging is important to help maximize useful life of the battery. Do not store the internal battery for extended periods, without recharging, as this may reduce the maximum life.



**WARNING:**

For the AC (“mains”) power cable to be properly secured, the attachment located on the power cable must be fitted into the power cable holder incorporated in the battery access cover and located under the AC (mains) power socket. Refer to section 6.2, *Connecting to External AC Power*.



**WARNING:**

The power supply to which the ventilator is connected (both AC and DC) must comply with all applicable standards and provide electrical power corresponding to the voltage characteristics inscribed on the rear of the ventilator to ensure correct operation. Refer also to the electrical specifications found in Appendix B, *Specifications*.



**WARNING:**

Ensure that the ventilator’s internal battery is fully charged before connecting the ventilator to an external DC power source. Powering the ventilator using an external 12–30 VDC power source (via the DC power cable) does not enable its internal battery to recharge.



**WARNING:**

Due to the internal battery’s limited reserve capacity, the ventilator should only be operated on the internal battery when no other power source is available. Ensure that the internal battery never becomes fully discharged.




**WARNING:**

When using a car auxiliary adapter (cigarette lighter) ensure the car has been started prior to plugging in the ventilator’s DC adapter. Refer to section 6.3, *Connecting to an External DC Power Source*.





**WARNING:**

Even if the internal battery charging indicator is off, charging of the battery may sometimes be incomplete if the ambient temperature is above 40°C (104°F) because of the battery’s internal heat safety device.


 **WARNING:**  
When the Low Battery alarm is triggered, immediately connect the ventilator to an AC power supply to maintain ventilation and recharge the internal battery.


 **WARNING:**  
Batteries should be disposed of according to environmental legislation in your country and locality.


 **WARNING:**  
Never expose any batteries to direct flame.

 **WARNING:**  
Ensure that the AC power cable is in perfect condition and not compressed. The device should not be turned on if the AC power cable is damaged.


### 1.2.4 Warnings Regarding Hoses and Accessories

 **WARNING:**  
The ventilator must not use, nor be connected to, any anti-static or electrically conductive hoses, tubing, or conduits.



 **WARNING:**  
Minimum and maximum VTE alarm parameters must be properly set to warn in the event of patient disconnection.

 **WARNING:**  
Before opening the packaging for the patient circuit, ensure that no damage is evident to the packaging or its contents. Do not use if evidence of damage exists.

 **WARNING:**  
The patient circuit should not be changed during ventilation.

 **WARNING:**  
On a DAILY basis, inspect the patient circuit to ensure that it shows no signs of damage, is properly connected, and is operating correctly without leakage.

 **WARNING:**  
Single use accessories should not be reused.

 **WARNING:**  
The exhalation block is intended for single use by a single patient . It may periodically be cleaned, but it cannot be disinfected or sterilized. To maintain good measurement quality when used continuously,



clean the exhalation block periodically (refer to section 9.3, *Cleaning the Exhalation Block*). The exhalation block should be changed every 4 months and cannot be reused with any other patient.



**WARNING:**

During invasive ventilation (when an artificial airway bypasses the patient's upper respiratory system), the patient's upper respiratory system cannot humidify the incoming gas. For this reason, a humidifier, to minimize drying of the patient's airway and subsequent irritation and discomfort, must be used.



**WARNING:**

If exhaled tidal volume measurements are required to ensure correct patient ventilation a double-limb patient circuit configuration must be used in order to detect leaks. In this case, both the minimum and maximum VTE alarm parameters must be properly set to warn in the event of patient disconnection.



**WARNING:**

Failing to replace a dirty air inlet filter or operating the ventilator without a filter may cause serious damage to the ventilator.



**WARNING:**

Before cleaning the ventilator, first disconnect the ventilator and the patient circuit.



**WARNING:**

If the ventilator is used indoors, the condition of the air inlet filter should be checked monthly. If the ventilator is used outdoors or in a dusty environment, the filter should be checked weekly and replaced as necessary.



**WARNING:**

The air inlet filter is not reusable; do not attempt to wash, clean, or reuse it.



**WARNING:**

The patient circuit should always be positioned to avoid hindering the patient's movements, to prevent accidental disconnection or leakage, and to minimize the risk of patient strangulation.



**WARNING:**

For pediatric use, ensure that the patient circuit type fits, and, in all respects, is suitable for use with a child. Use a pediatric circuit for patients that weigh under 53 lb. (23 kg). To ensure proper performance of the ventilator, use a recommended patient circuit; see [Table H-2](#).




**WARNING:**


Resistance of the exhalation valve and accessories (water traps, filters, HMEs, etc.) must be as low as possible.





**WARNING:**


Adding attachments to the ventilator breathing system can cause the pressure during exhalation at the patient connection port to increase.


 **WARNING:**  
The exhalation valve must allow rapid discharge of the circuit pressure. Ensure that the exhalation valve is always clean and its evacuation aperture (exhaust port) is never obstructed.


 **WARNING:**  
Users must always possess an additional breathing circuit and exhalation valve while using the Puritan Bennett™ 560 ventilator.


 **WARNING:**  
Always ensure that the humidification device is positioned lower than both the ventilator and the patient. Use water traps, if necessary, to limit water in the patient circuit and periodically empty these water traps. Take precautions when discarding the fluid in the water trap. Discard per local ordinance for proper disposal.







 **WARNING:**  
Use of a nebulizer or humidifier can lead to an increase in the resistance of inspiratory and exhalation filters. Monitor the filters frequently for increased resistance or blockage.

 **WARNING:**  
If a heated humidifier is used, you should always monitor the temperature of the gas delivered to the patient. Gas delivered from the ventilator that becomes too hot may burn the patient's airway.



 **WARNING:**  
Adding accessories to the ventilator breathing circuit, such as a humidifier and water trap(s), may result in a decrease in tidal volume delivered to the patient due to the added compressible volume of the accessory. Always assure that the patient is receiving the appropriate inspired volume when altering the breathing circuit configuration.


 **WARNING:**  
The level of inspiratory resistance of the circuit and accessories (bacteria filter, humidifier, HMEs, etc.) must be as low as possible. Settings—particularly the Patient Disconnection alarm, maximum inspired volume (Max VTI), and minimum inspired volume (Min VTI) settings—must be periodically adjusted according to changes in the patient circuit resistance—especially when filters are replaced.


 **WARNING:**  
To ensure proper performance of the ventilator, use a patient circuit recommended by Covidien in this manual; refer to Chapter 6, *Installation and Assembly* and Appendix H, *Parts and Accessories*. The total specified length of the patient circuit tubing as measured from the ventilator outlet to the ventilator inlet is 1.1 meters (3.6 feet) to 2.0 meters (6.6 feet). The tubing must conform to all applicable standards and must be fitted with Ø 22 mm terminals that also conform to all applicable standards. Ensure that both the length and the internal volume of the patient circuit are appropriate for the tidal volume: a corrugated tube of Ø 22 mm for adult patients, and a corrugated tube of Ø 15 mm for pediatric patients with a tidal volume lower than 200 ml.


-  **WARNING:**  
To ensure proper performance of the ventilator, use only accessories (including oxygen accessories) approved and recommended by Covidien. See Appendix *H, Parts and Accessories* or contact your customer services.
-  **WARNING:**  
To reduce the likelihood of disconnection and to prevent adverse ventilator performance, use only accessories compatible with the ventilator. Compatibility is determined by reviewing the instructions for use of either the ventilator or the accessories.
-  **WARNING:**  
When using non-invasive ventilation (NIV) without an exhalation valve, use a vented nose or face mask or a non vented combined with a leak accessory. When using non-invasive ventilation (NIV) with an exhalation valve, use a non-vented mask.
-  **WARNING:**  
Before using the nurse call system, ensure that its connections are secure and it operates properly. For more information, contact Covidien.
-  **WARNING:**  
To connect the ventilator to a nurse call device, contact Covidien to check the ventilator's compatibility with the nurse call device and order a suitable connection cable.
-  **WARNING:**  
Do not use nurse call devices that operate based on the closure of an electrical circuit, because the devices often do not take into account possible cable disconnection or a total loss of power. Ensure that the nurse call device is always connected to the ventilator.


### 1.2.5 Warnings Regarding Settings


-  **WARNING:**  
Before starting ventilation, always verify that all settings are properly set in accordance with the required prescription.
-  **WARNING:**  
Before starting ventilation, ensure that the device is properly assembled and that the air inlet, cooling vents, and alarm sound diffusion holes are not obstructed. Ensure also that the patient circuit is of the proper configuration (double or single limb), properly connected to the ventilator, and that the circuit hoses are neither damaged nor compressed and contain no obstructions or foreign bodies.


 **WARNING:**  
The CPAP mode does not provide a set respiratory rate. Do not use this mode for ventilator-dependent patients.


 **WARNING:**  
Do not allow a patient to remain connected to the ventilator when ventilation is stopped, because a substantial quantity of exhalation gas, primarily carbon dioxide, may be inhaled by the patient.


 **WARNING:**  
Alarm volume should be adjusted with respect to the ventilator's operating environment and so that the patient's caretakers can hear the alarms. The audible alarm vents located at the front of the device should never be obstructed. The alarm can be paused with the Alarm Pause function by pressing the ALARM CONTROL key twice once the alarm has been declared.


 **WARNING:**  
Ensure that the I Sens setting is not set to OFF when ventilating patients capable of triggering spontaneous breaths.











 **WARNING:**  
The ventilator offers a variety of breath delivery options. Throughout the patient's treatment, the clinician should carefully select the ventilation mode and settings to use for that patient, based on clinical judgment, the condition and needs of the patient, and the benefits, limitations, and characteristics of the breath delivery options. As the patient's condition changes over time, periodically assess the chosen modes and settings to determine whether those are best for the patient's current needs.

 **WARNING:**  
In adult or pediatric use ensure that the adjusted tidal volume is compatible with the needs of the patient.

 **WARNING:**  
When changing the mode during ventilation, significant transitions of pressure, flow or cycling rate might occur, depending on the difference between the modes. Before setting the new mode, first ensure that the settings between the different modes are compatible. This reduces the risk of discomfort and harm to the patient.

 **WARNING:**  
Do not conduct the ventilator alarm test while the patient is connected to the ventilator. Switch the patient to an alternate means of ventilation before testing.

 **WARNING:**  
The Min PIP alarm setting must be adjusted for the patient, but must also be set high enough to allow the Patient Disconnection alarm to trigger properly. Perform the low pressure test (see section [F.1, Low Pressure Test](#)) to ensure that the alarm is properly set.

-  **WARNING:**  
The Max Leak alarm setting must be adjusted for the patient, but must also be set low enough to allow the High Leakage alarm to trigger properly. Perform the max leak test (see section [F.2, Max Leak Test \(Only NIV\)](#)) to ensure that the alarm is functioning properly. This alarm only applies to leak configuration (NIV).
-  **WARNING:**  
If Apnea Time is set to a value higher than 60/Control R then the Apnea alarm will not activate.
-  **WARNING:**  
If an Apnea alarm is required, set the Apnea setting to YES in the Preferences Menu.
-  **WARNING:**  
The Apnea alarm should be set to YES for ventilator dependent patients.
-  **WARNING:**  
Setting any alarm limits to OFF or extreme high or low values can cause the associated alarm not to activate during ventilation, which reduces its efficacy for monitoring the patient and alerting the clinician to situations that may require intervention.
-  **WARNING:**  
Ensure the Insp Time setting is compatible with the physiological requirements of the patient.
-  **WARNING:**  
Adjustable alarms should not be systematically canceled; instead, they should be adjusted according to the needs and condition of the patient.
-  **WARNING:**  
Do not pause, disable, or decrease the volume of the ventilator's audible alarm if patient safety could be compromised.
-  **WARNING:**  
A continuous alarm condition will be activated if the ventilator power switch is turned off while ventilation is in progress. When the power switch is turned back on again, the ventilation will resume without having to press the VENTILATION ON/OFF button.
-  **WARNING:**  
In the SIMV mode the use of a double-limb circuit is recommended. The Min VTE setting should remain active in the event that pressure losses are present on the patient circuit downstream from the proximal pressure link. In such cases the Patient Disconnection alarm would not be systematically activated in case of a disconnection of the circuit.



**WARNING:**

The inspiration trigger threshold should be carefully modified in order to avoid the risk of false triggering or “autotriggering” of the ventilator. For example, Level 0P, the most sensitive mode, is recommended for pediatric use. However, for an adult, this setting may result in autotriggering.



**WARNING:**

The sound level of the alarms should be adjusted according to the installation environment and the size of the area monitored by the patient’s caregiver. Ensure that the alarm sound apertures at the front of the device are never obstructed.

### 1.2.6 Warnings Regarding PC Connection and USB Memory Devices



**WARNING:**

Do not connect the ventilator to any device other than a PC with a dedicated compatible Puritan Bennett™ software package.



**WARNING:**

Always verify the file ID before using a USB memory device to transfer data between the ventilator and a PC.



**WARNING:**

USB connections are not intended for connection to any devices other than the specified USB flash storage (see section [7.7.1, USB Memory Device Specifications](#)).

### 1.2.7 Warnings Regarding Maintenance



**WARNING:**

Never use a ventilator or any components or accessories that appear to be damaged. If any signs of damage are evident, contact your equipment supplier or Covidien.














**WARNING:**

To ensure proper servicing and avoid the possibility of physical injury to personnel or damage to the ventilator, only personnel authorized and qualified by Covidien should attempt to service or make authorized modifications to the Puritan Bennett™ 560 ventilator.



**WARNING:**


If you cannot determine the cause of a problem with your ventilator, contact your equipment supplier. Do not use the ventilator until the problem has been corrected.

-  **WARNING:**  
To ensure proper performance of the ventilator, the preventative maintenance schedule should be followed. For further information contact Covidien.
-  **WARNING:**  
On a daily basis, ensure the proper connection and operation of the patient circuit.
-  **WARNING:**  
If a problem with the ventilator is suspected, **FIRST CHECK THAT THE PATIENT IS NOT IN DANGER.** If necessary, remove the patient from the ventilator and provide an alternative means of ventilation.
-  **WARNING:**  
After assembling, cleaning, or reassembling the patient circuit, and on a daily basis, inspect the hoses and other components to ensure that there are no cracks or leaks and that all connections are secure.
-  **WARNING:**  
Use all cleaning solutions and products with caution. Read and follow the instructions associated with the cleaning solutions you use to clean your ventilator. Use only those solutions listed in [Table 9-1](#).
-  **WARNING:**  
Never use a liquid cleaner inside the patient circuit, or on any component of a gas pathway. Clean the patient circuit only as specified by the manufacturer's instructions.
-  **WARNING:**  
Do not attempt to open, repair or otherwise service the ventilator yourself. Doing so might endanger the patient, damage the ventilator, or void your warranty. Only personnel authorized and qualified by Covidien should repair, open or service the ventilator.
-  **WARNING:**  
If the ventilator is damaged, or its external housing is not correctly closed, or it behaves in a way that is not described in this manual (excessive noise, heat emission, unusual odor, alarms not triggered during the start-up procedure), the oxygen and power supplies should be disconnected and use of the device stopped immediately.
-  **WARNING:**  
The exhalation block is intended for single use by a single patient . It may periodically be cleaned, but it cannot be disinfected or sterilized. To maintain good measurement quality when used continuously, clean the exhalation block periodically (refer to section 9.3, [Cleaning the Exhalation Block](#)). The exhalation block should be changed every 4 months and cannot be reused with any other patient.
-  **WARNING:**  
Ensure that the exhalation block is completely dried after cleaning and prior to use.

**WARNING:**

When an exhalation block is set up, each time it is removed, or after installing a new exhalation block on the machine, it is essential that the exhalation flow sensor be recalibrated before the exhalation block is used. Refer to section [10.3, \*Calibrating the Exhalation Flow Sensor\*](#).

**WARNING:**

The patient circuit is intended for single use by a single patient  and should be changed according to the manufacturer's recommendations and according to the patient circuit lifetime. Refer to the instructions for use supplied by the manufacturer of the patient circuit (included with the ventilator) and Chapter [6, \*Installation and Assembly\*](#).

**WARNING:**

A patient treated by mechanical ventilation is highly vulnerable to the risks of infection. Dirty or contaminated equipment is a potential source of infection. Clean the ventilator and its accessories regularly and systematically before and after each use and following any maintenance procedure to reduce the risks of infection. The use of a bacterial filter at the ventilator's outlet (TO PATIENT) port—or both ports if a double-limb circuit is used—is recommended. Refer to Chapter [9, \*Cleaning\*](#).

**WARNING:**

Regularly check the cleanliness of the air inlet filter located on the rear of the ventilator. If necessary, replace the filter before the recommended replacement period is over (see Chapter [10, \*Routine Maintenance\*](#)). This is particularly important when the ventilator is installed on a wheelchair, because environmental conditions may cause the filter to become dirty more rapidly.

**WARNING:**

For environmental protection, the ventilator and its components, whatever their respective conditions of operation, cannot be disposed of with household waste and must be submitted for suitable selective collection and possible recycling. Observe all applicable regulations when disposing of the ventilator and any of its components.

**WARNING:**

Before using the ventilator's internal battery, ensure that the battery is fully charged and that the charge holds. Back up ventilators or those in storage should be connected to an AC power source to protect the integrity of the battery.

**WARNING:**

The maximum recommended shelf life of the internal battery is 2 years. Do not use a battery that has been stored for 2 years prior to its first use. Periodic recharging is important to help maximize useful life of the battery. Do not store the internal battery for extended periods, without recharging, as this may reduce the maximum life.

**WARNING:**

To connect the ventilator to an external power source, first ensure the ventilator's I/O (power) switch is off (O). Then, connect the desired power cable to the ventilator. Finally, connect the power cable to the external power source.



**WARNING:**

To disconnect the ventilator from an external power source, first power down the ventilator. Then, disconnect the power cable from the external power source and, finally, the ventilator.

**WARNING:**

Connect the external DC power source by first connecting the power cable to the ventilator and then to the external DC source. Follow the reverse procedure to disconnect the device from the external DC power source.

**WARNING:**

Connect the external electrical power source by first connecting the power cable to the ventilator and then to the external power source. Follow the reverse procedure to disconnect the device from electrical power sources.

### 1.2.8 Warnings Regarding Oxygen

**WARNING:**

The ventilator must not be used with flammable anesthetic substances.

**WARNING:**

Oxygen therapy for patients with respiratory failure is a common and effective medical prescription. However, be aware that inappropriate oxygen use may potentially lead to serious complications, including, but not limited to, patient injury.

**WARNING:**

Strictly follow the instructions provided in section [6.8.2, \*Connecting the Oxygen Supply\*](#), which include the use of a flow regulator and special oxygen connector.

**WARNING:**

To avoid injury to the patient and/or possible damage to the ventilator: before connecting the ventilator to the oxygen supply, ensure a flow meter (flow regulator) is connected to the ventilator to regulate the oxygen supply to the required specification.

**WARNING:**

The Puritan Bennett™ 560 ventilator can be used with an optional oxygen analyzer with minimum and maximum concentration alarms. Always measure the delivered oxygen with a calibrated oxygen analyzer (FiO<sub>2</sub> kit) that features a minimum and maximum concentration alarm in order to ensure that the prescribed oxygen concentration is delivered to the patient.

**WARNING:**

The Puritan Bennett™ 560 ventilator is designed to deliver a percentage of oxygen equal or lower than 50%. Do not exceed this value as this may cause the ventilator to malfunction and put the patient at risk.



**WARNING:**

Ensure that the oxygen supply pressure to the machine never exceeds 7 psi (50 kPa) or a flow of 15 lpm. For volume and sensitivity tolerances, refer to [Table B-8](#).



**WARNING:**

In the event of an oxygen leak, shut down the supply of oxygen at its source. In addition, remove and/or keep any incandescent source away from the device, which may be enriched with oxygen. Circulate fresh air into the room to bring the oxygen level down to normal.



**WARNING:**

The hose connecting the ventilator to the oxygen source must be designed exclusively for use with medical-grade oxygen. Under no circumstances should the oxygen hose be modified by the user. In addition, the hose must be installed without the use of lubricants.



**WARNING:**

Ensure that the only gas supplied to the ventilator through the dedicated oxygen supply connector is medical-grade oxygen.



**WARNING:**

The coupler must not remain connected to the oxygen inlet unless it is also connected to a leak-proof, external oxygen gas source. When an oxygen supply is not being used with the ventilator, disconnect the oxygen source completely from the ventilator.



**WARNING:**

To prevent any interference with the internal sensors of the ventilator, do not install a humidifier upstream of the ventilator.



**WARNING:**

To ensure stability, when the Puritan Bennett™ 560 ventilator is mounted on a cart, the weight of the oxygen bottle should not exceed 14 kg (30 lbs).



**WARNING:**

The oxygen supply hose ages even when it is not in use and should be replaced periodically. Follow the expiration date, if any.




**WARNING:**


The oxygen supply must be regulated using a flow meter connected to the source gas outlet.




**WARNING:**


The oxygen supply must be shut off when ventilation is interrupted. Before disconnecting the oxygen hose, allow the ventilator to continue for a few cycles without oxygen to flush the patient circuit of excess oxygen.


 **WARNING:**  
Before connecting the oxygen supply, ensure that the stud on the oxygen inlet is protruding outwards.

 **WARNING:**  
Inspect the oxygen coupler before use to ensure it has its black O-ring attached and in good condition. Do not use an oxygen coupler with a missing, damaged, or worn O-ring.

### 1.2.9 Warnings Regarding Electromagnetic Interference



 **WARNING:**  
The Puritan Bennett™ 560 ventilator requires special precautions for electromagnetic compatibility and should be installed and started according to the recommendations found in Appendix B, *Specifications*. In particular, the use of nearby mobile and portable communications equipment using radio frequencies, such as mobile telephones or other systems exceeding the levels set in the IEC 60601-1-2 standard, may affect its operation. Refer to section B.10, *Manufacturer's Declaration*.

 **WARNING:**  
Portable RF communications equipment (including peripherals such as antenna cables and external antennas) should be used no closer than 30 cm (12 inches) to any part of the ventilator, including cables specified by the manufacturer. Otherwise, degradation of the performance of this equipment could result.














 **WARNING:**  
The use of any accessory other than those specified, with the exception of the power supplies or cables sold by Covidien, may lead to an increase in electromagnetic emissions or a decrease in the equipment protection against electromagnetic emissions. If the ventilator is used adjacent to such accessories or stacked with such devices, the ventilator's performance should be monitored to verify normal operation.

## 1.3 Symbols and Markings



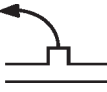







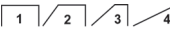
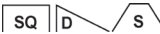

Table 1-1. Ventilator Symbols

Symbols	Descriptions
	It is essential to read, understand, and follow these instructions before using the Puritan Bennett™ 560 ventilator (ISO 7000-0434A). This symbol appears on the ventilator's back panel, see item 5 in <i>Table 1-2</i> .
	It is mandatory to read, understand, and follow these instructions before using the Puritan Bennett™ 560 Ventilator (ISO 7010-M002). This symbol appears on the ventilator's air inlet label, see item 5 in <i>Table 1-2</i> .
















**Table 1-1.** Ventilator Symbols (Continued)

Symbols	Descriptions
	<p>Type BF applied part (IEC 60417-5333).</p> <p>A regulatory standard classification for protection against electrical shock for the part of the device that contacts the patient.</p> <p>This symbol appears on the ventilator's back panel; see item 5 in <a href="#">Table 1-2</a>.</p>
	<p>Direct current, DC (IEC 60417-5031).</p> <p>This symbol appears on the ventilator's front panel and back panel; see Figure 1-1, and item 9 in <a href="#">Figure 1-3</a>.</p>
	<p>Alternating current, AC (IEC 60417-5032).</p> <p>This symbol appears on the ventilator's front panel and back panel; see item 8 in <a href="#">Figure 1-3</a>, and item 10 in <a href="#">Figure 2-3</a> (page 2-6).</p>
	<p>Internal battery.</p> <p>This symbol appears on the ventilator's front panel; see item 10 in <a href="#">Figure 2-3</a> (page 2-6).</p>
	<p>Insulation class II equipment (IEC 60417-5172).</p> <p>A regulatory standard classification for protection against electric shock. Class II equipment relies on double insulation rather than protective earthing.</p> <p>This symbol appears on the ventilator's back panel; see item 5 in <a href="#">Table 1-2</a>.</p>
<p><b>IP32</b></p>	<p>Index of Protection rating for the ventilator's enclosure, defined in IEC 60529 (BSEN60529).</p> <p>The first digit, 3, indicates protection against the intrusion of small foreign bodies (including fingers, tools, wires, etc. with a diameter greater than 2.5 mm) into the ventilator. The second digit, 2, indicates protection against water dripping or falling vertically when the enclosure is tilted at an angle of up to 15° from its normal position, as well as an environment featuring water vapor condensation and/or light rain.</p> <p>This rating appears on the ventilator's back panel; see item 5 in <a href="#">Table 1-2</a>.</p>
	<p>CSA—Canadian Standards Association.</p> <p>This symbol appears on the ventilator's back panel; see item 5 in <a href="#">Table 1-2</a>.</p>
	<p>CE—Conformity European</p> <p>Signifies compliance with the medical device directive 93/42/EEC as amended by 2007/47/EC.</p> <p>This symbol appears on the ventilator's back panel; see item 5 in <a href="#">Table 1-2</a>.</p>
	<p>This combined symbol appears on the ventilator's UP/UNFREEZE key; see item 4 in <a href="#">Figure 2-3</a> (page 2-6).</p> <p>This key is used to: move the LCD display's cursor upwards, line-by-line; increase the value of displayed and selected parameter settings; restart ("unfreeze") waveforms tracing.</p>
	<p>This combined symbol appears on the ventilator's DOWN/FREEZE key; see item 6 in <a href="#">Figure 2-3</a> (page 2-6).</p> <p>This key is used to: move the LCD display's cursor downwards, line-by-line; decrease the value of displayed and selected parameter settings; stop ("freeze") waveforms tracing.</p>
	<p>This symbol appears on the ventilator's ENTER key; see item 5 in <a href="#">Figure 2-3</a> (page 2-6).</p> <p>This key is used to confirm command actions.</p>
	<p>This combined symbol appears on the ventilator's ALARM CONTROL key; see item 2 in <a href="#">Figure 2-3</a> (page 2-6).</p> <p>This key is used to: cancel the audible portion of alarms for 60 seconds at a time; cancel an alarm. For more information, see <a href="#">Appendix F, Alarms Tests</a>.</p>
	<p>This symbol appears on the ventilator's MENU key; see item 7 in <a href="#">Figure 2-3</a> (page 2-6).</p> <p>This key is used to access the ventilator's menus via the ventilator's front panel LCD display.</p>
	<p>This symbol (IEC 60417-5009) appears on the ventilator's VENTILATION ON/OFF button; see item 8 in <a href="#">Figure 2-3</a> (page 2-6).</p> <p>This button is used to start and stop ventilation.</p>







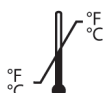





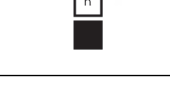
**Table 1-1.** Ventilator Symbols (Continued)

Symbols	Descriptions
	<p>TO PATIENT port. This symbol appears on the front right of the ventilator, adjacent to the TO PATIENT port; see item 1 in Figure 1-1.</p>
	<p>FROM PATIENT port (double-limb option). This symbol appears on the front left of the ventilator, adjacent to the FROM PATIENT port; see item 4 in Figure 1-1.</p>
	<p>Patient proximal pressure port. This symbol appears on the front right of the ventilator, adjacent to the proximal pressure and TO PATIENT ports; see Figure 1-1, and item 3 in Figure 1-4.</p>
	<p>Exhalation valve pilot port. This symbol appears on the front right of the ventilator, adjacent to the exhalation valve and TO PATIENT ports, indicating the connection of the tubing between the patient circuit exhalation valve; see Figure 1-1, and item 3 in Figure 1-4.</p>
	<p>Oxygen inlet. This marking appears on the back panel of the ventilator, adjacent to the oxygen inlet port; see item 2 in Figure 1-3.</p>
	<p>Nurse call connection. This symbol appears on the back panel of the ventilator, adjacent to the nurse call receptacle; see item 12 in Figure 1-3.</p>
	<p>Switch in "Off" position (IEC 60417-5008). This symbol appears on the I/O (power on/off) switch on the back panel of the ventilator to indicate the switch's "Off" position. See item 2 in Figure 2-2 (page 2-5).</p>
	<p>Switch in "On" position (IEC 60417-5007). This symbol appears on the I/O (power on/off) switch on the back panel of the ventilator to indicate the switch's "On" position. See item 2 in Figure 2-2 (page 2-5).</p>
	<p>Software lock enabled. This symbol appears at upper left in the ventilator's LCD display when the keyboard Locking key is enabled; see section 7.8, <i>Locking the Control Panel</i>.</p>
	<p>Internal battery. This symbol appears at top center in the ventilator's LCD display to indicate that the ventilator is being powered by its internal battery. See item 1 in Figure 2-4 (page 2-7) and Chapter 8, <i>Internal Battery</i>, for more information.</p>
	<p>Pressure rise times (inspiratory phase) parameter. These symbols appear on the ventilation mode menu screens. For more information, see Chapter 3, <i>Operating Parameters</i>. In pressure ventilation modes, you can select one of four rise times with setting 1 representing the fastest rise time and setting 4 representing the slowest.</p>
	<p>Flow shape ("flow distribution shape", inspiratory phase) parameter. These symbols appear on the ventilation mode menu screens; selectable for V A/C mode only. For more information, see Chapter 3, <i>Operating Parameters</i>. In volume ventilation mode you can select between Square (SQ), Descending (D) or Sinusoidal (S) flow patterns.</p>
	<p>Selected line (filled square). When making menu choices, this graphic indicates the line on which the cursor is currently positioned. See Figure 7-16 (page 7-15).</p>

**Table 1-1.** Ventilator Symbols (Continued)

Symbols	Descriptions
	Non-selected line (empty square). When making menu choices, this graphic indicates a line on which the cursor is currently not positioned.
	Locked parameter line. When making menu choices, this graphic indicates a line that cannot be selected (the Locking key is enabled).
	Active parameter line. When making menu choices, this graphic indicates that the current parameter is selected and can be changed. See Chapter 7, <i>Operating Procedures</i> .
	Inspiratory effort detected. This symbol appears in the front panel display's Status window when the patient triggers a breath.
	Parameter adjustment bar. This graphic shows the current setting for parameters such as display contrast and alarm volume in the Preferences menu. See section 7.3, <i>Preferences Menu Parameters</i> .
	WEEE (Waste Electrical and Electronic Equipment). This symbol means that this product must not be disposed of with household waste. Observe local ordinances for proper disposal. See item 5 in <i>Table 1-2</i> .
	Year of manufacture.
	Manufacturer.
	Authorized representative.
	Audio Paused (ALARM CONTROL key pressed once). This symbol means the sounding of audible alarms is currently disabled. This period lasts 60 seconds. For more information, see section 5.5, <i>Pausing the Audible Portion of Alarms</i> .
	Alarm Paused (ALARM CONTROL key pressed twice). This symbol means one or more alarms have been paused, or reset/canceled. The alarm is paused until the alarm condition is corrected and the condition reoccurs. For more information, see section 5.6, <i>Pausing and Resetting Alarms</i> .
	Alarm off (Apnea off). This symbol means that the Apnea alarm has been set to OFF in the Preferences menu. For more information, see section 5.6, <i>Pausing and Resetting Alarms</i> .
	Exhalation valve detected. This symbol means that an exhalation valve has been detected during ventilation.
	No exhalation valve detected. This symbol means that no exhalation valve has been detected during ventilation.
	Single patient use only (ISO 7000-1051). This symbol means that the labeled device is for use by a single patient only.

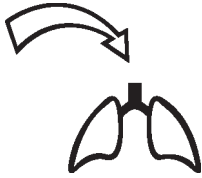

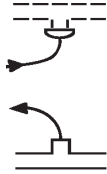
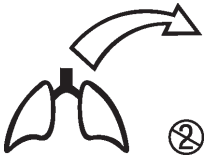
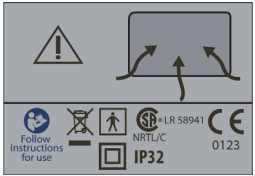
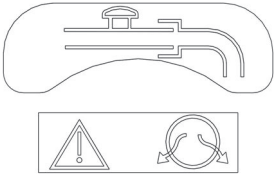
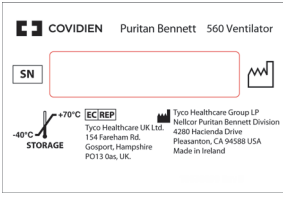
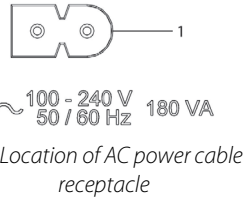
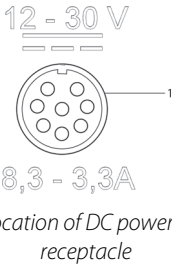
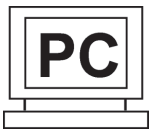



**Table 1-1.** Ventilator Symbols (Continued)

Symbols	Descriptions
	<p>Freeze waveforms.</p> <p>This symbol means the tracing of patient pressure and flow waveforms is currently paused or “frozen.” For more information, see section 4.4, <i>Waveform Display</i>.</p>
	<p>Follow instructions for use (ISO 7000-1641).</p> <p>This symbol directs the user to observe and adhere to the instructions contained in the product’s user manuals.</p>
	<p>USB port.</p> <p>This symbol indicates a communications port for interfacing with a USB connector. See item 11 in <i>Figure 1-3</i>.</p>
	<p>PC connector.</p> <p>This symbol indicates a port that can be used by authorized Covidien product service personnel or Covidien service personnel for software maintenance. See item 10 in <i>Figure 1-3</i>.</p>
	<p>Atmospheric pressure limitations. See section B.7 for specifications.</p>
	<p>Humidity limitations. See section B.7 for specifications.</p>
	<p>Temperature limitations. See section B.7 for specifications.</p>
	<p>Fragile.</p>
	<p>Keep dry.</p>
	<p>Keep away from direct sunlight.</p>
	<p>This side up.</p>
	<p>Stacking limitation.</p> <p>The number shown (represented by “n”) indicates the maximum number of additional identical packages that may be stacked on top of a package containing this device, when this device is correctly packaged.</p> <p>For the Puritan Bennett™ 560 ventilator, n = 2.</p>
	<p>Lithium battery.</p> <p>This symbol indicates that the contents of the package contain lithium batteries.</p>

## 1.4 Labels (Identification and Instruction Information)

Various labels or specific markings are affixed to the ventilator that describe precautions to be taken for the correct use of the ventilator and contribute to the traceability of the product. See Table 1-2 and the figures on the following pages for illustrations of these labels and markings and their locations on the ventilator. Use the item numbers in Table 1-2 to locate the labels in Figures 1-1 through 1-4.

**Table 1-2.** Ventilator Labels and Markings

			
<p>1. TO PATIENT port label (Figures 1-1 and 1-4)</p>	<p>2. Oxygen inlet marking and label (Figure 1-3)</p>	<p>3. Exhalation valve and patient pressure connection label (Figures 1-1 and 1-4)</p>	<p>4. FROM PATIENT port, exhalation limb connection of patient circuit—single use exhalation block label (Figures 1-1, 1-2, and 1-4)</p>
			
<p>5. Air inlet label (Figure 1-3)</p>	<p>6. Exhaled gas outlet label (Figure 1-2)</p>	<p>7. Identification label (Figure 1-4)</p>	<p>8. AC power (mains) cable receptacle marking (Figure 1-3)</p>
			
<p>9. External DC cable receptacle marking (Figure 1-3)</p>	<p>10. PC connection marking (Figure 1-3)</p>	<p>11. USB port marking (Figure 1-3)</p>	<p>12. Nurse call cable receptacle marking (Figure 1-3)</p>
			
<p>13. FiO<sub>2</sub> label (Figures 1-1 and 1-4)</p>			





**Note:**

The item number callouts in the following figures refer to those listed in *Table 1-2*.

**Figure 1-1.** Locations of Labels—Top-Front View



**Figure 1-2.** Locations of Labels—Front-Left View



Figure 1-3. Location of Labels and Markings—Rear View

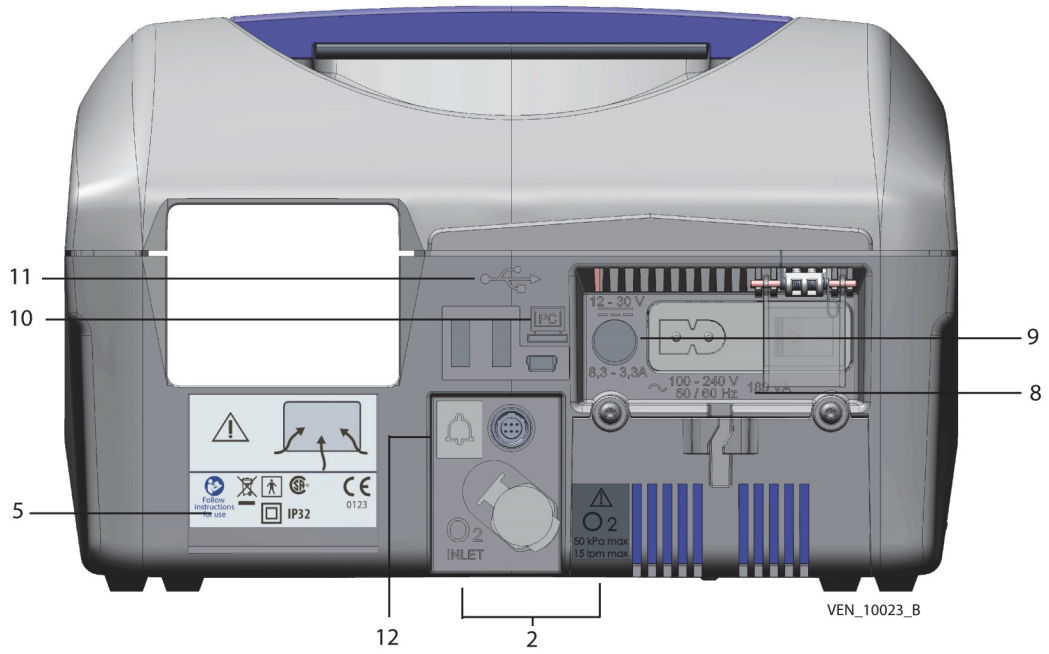
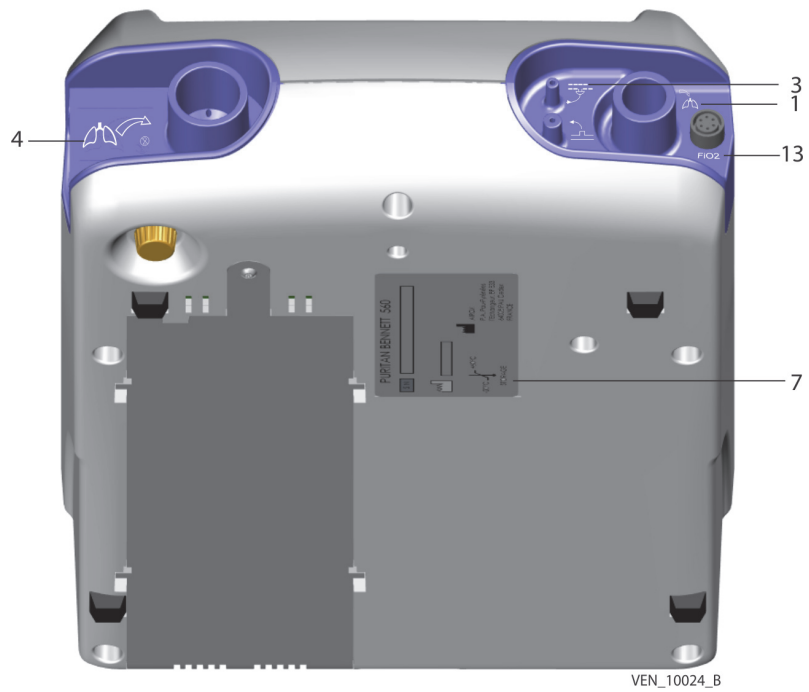


Figure 1-4. Location of Labels—Bottom View



## 2 Ventilator Overview

### 2.1 Indications for Use

The Puritan Bennett™ 560 Ventilator is indicated for the continuous or intermittent mechanical ventilatory support of patients weighing at least 11 lb (5 kg) who require mechanical ventilation. The ventilator is a restricted medical device intended for use by qualified, trained personnel under the direction of a doctor. It is essential to read, understand, and follow these instructions before using the Puritan Bennett™ 560 Ventilator.

#### 2.1.1 Target Patients

Specifically, the ventilator is applicable for adult and pediatric patients who require the following general types of invasive or non-invasive ventilatory support, as prescribed by an attending doctor:

- Positive Pressure ventilation
- Assist/Control, SIMV, or CPAP modes of ventilation
- Breath types including Volume Control, Pressure Control, and Pressure Support

#### 2.1.2 Target Environments

The ventilator is suitable for use in institutional, home, and portable settings. It is not intended for use in Emergency Medical Service (EMS), such as an emergency transport.

The Puritan Bennett™ 560 Ventilator is suitable for use on commercial aircraft, per FAA requirements. See section [B.11, Standards Compliance and IEC Classification](#). Patients traveling with the Puritan Bennett™ 560 Ventilator may be required by their airline to demonstrate evidence of compliance with the RTCA/DO-160F standard, as well as other requirements. Contact your airline prior to travel to determine airline specific requirements and documentation.



#### **WARNING:**

**Even though the Puritan Bennett™ 560 Ventilator meets current safety standards, the internal Lithium-ion battery of the device exceeds the 100Wh threshold and is therefore considered to be Dangerous Goods (DG) Class 9 – Miscellaneous, when transported in commerce. As such, the Puritan Bennett™ 560 Ventilator and/or the associated Lithium-ion battery are subject to strict transport conditions under the Dangerous Goods Regulation for air transport (IATA: International Air Transport Association), International Maritime Dangerous Goods code for sea and the European Agreement concerning the International Carriage of Dangerous Goods by Road (ADR) for Europe. Private individuals who transport the device are excluded from these regulations although for air transport some requirements apply. For air transport; the Puritan Bennett™ 560 Ventilator is permitted as**

**checked-in or carry-on baggage. Two spare batteries per person may be taken on board as carry-on luggage only, with the prior approval of the airline. This classification and regulatory requirements may vary depending upon the country and mode of transport. Therefore it is recommended that users verify with the carrier / airline as to which measures to take before the voyage.**

### 2.1.3 Target Operators



**WARNING:**

**This ventilator must be used only under the responsibility and on the prescription of a doctor.**

The ventilator may be operated by the following caregivers:

- Respiratory therapists
- Doctors
- Nurses
- Homecare providers
- Patient and patient's families

For more details on the knowledge and skill requirements for operating the Puritan Bennett™ 560 Ventilator, see Appendix A, *Patient and Caregiver Checklist*.

## 2.2 Contraindications

This ventilator is not for use with anesthetic gases, and is not intended for use as an emergency transport ventilator.

## 2.3 Operational Use

The Puritan Bennett™ 560 ventilator uses a micro-turbine to provide ventilatory support to patients. Clinicians may use a variety of interfaces to connect patients to the ventilator for continuous or intermittent ventilatory support. Some examples include mouthpieces; nasal masks or full face masks; endotracheal tubes or tracheotomy tubes. User-selectable ventilation modes are:

- Assisted Controlled Volume (V A/C)
- Assisted Controlled Pressure (P A/C)
- Volume Synchronized Intermittent Mandatory Ventilation (V SIMV)
- Pressure Synchronized Intermittent Mandatory Ventilation (P SIMV)
- Continuous Positive Airway Pressure (CPAP)
- Pressure Support Ventilation with apnea ventilation (PSV/ST)

### 2.3.1 Safety Net

Incorporated in the ventilator design is an alarm system that continuously monitors both patient and machine for signs of specific errors or faults that could lead to an unsafe condition. Should any of these errors or faults be detected, the alarm system announces the specific alarm condition both audibly and visually. The machine-related alarm conditions are factory set, whereas the patient-related alarm conditions are defined by alarm-threshold values selected by an operator (a clinician or a caregiver). For more information, see Chapter 5, *Alarms and Troubleshooting*.

### 2.3.2 Settings



A software key, known as the Locking key, restricts access to ventilation parameter settings and ventilation mode changes in order to distinguish between clinician usage and patient usage (see *Locking the Control Panel* on page 7-35).

### 2.3.3 Oxygen Enrichment

Oxygen may be supplied from an external, low pressure source, but the oxygen flow must be limited to 15 lpm (50 kPa, 500 mbar). The ventilator automatically compensates for the extra flow created by the external oxygen supply (see Chapter 6, *Installation and Assembly*).

### 2.3.4 Breathing Circuit

The ventilator can be used with a single- or double-limb patient circuit. If exhaled volume monitoring is required (such as ventilator dependent patients), use the double-limb circuit for exhaled tidal volume monitoring. For more information, see *Patient Circuit* on page 6-9.



**WARNING:**

**Users must always possess an additional breathing circuit and exhalation valve while using the Puritan Bennett™ 560 ventilator.**

## 2.4 Device Classification

The ventilator's IEC/EN 60601-1 classification is as follows:

- Protection/insulation class (electric shock): Class II
- Protection index of enclosure: IP32
- Degree of protection against risk of electric shock: BF
- Power: External (AC–mains, or DC–cigarette lighter) or internal (DC–battery)
- Operation mode: Continuous operation

For additional information, see Appendix B, *Specifications*.

## 2.5 Front Panel

Figure 2-1. Front Panel

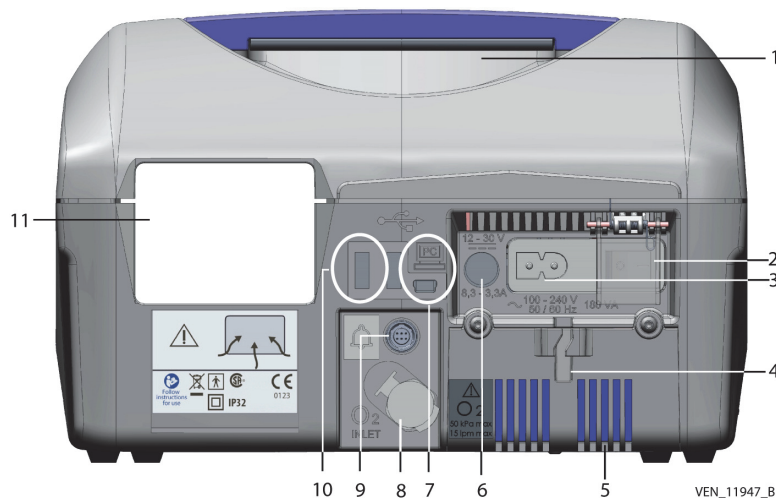


<p><b>1 LCD display</b>—Shows information about the ventilator, including patient hours and software version, ventilation modes and settings, and monitored and calculated patient data and waveforms. The display also allows the user to view and, using the control panel, adjust the ventilator’s operating and alarm configuration settings.</p>	<p><b>6 Exhalation valve port</b>—Nipple for providing piloting pressure to the exhalation valve. Controls the open-closed position of the exhalation valve.</p>
<p><b>2 Control panel</b>—Features the controls for setting up and operating the ventilator, and LEDs to indicate the ventilator’s power source, ventilation on/off status, and alarm priority level. Control functions include turning on and off the ventilation, configuring ventilation modes, pausing audible alarms, canceling alarms, and setting device and alarm parameters.</p>	<p><b>7 Lateral and front openings</b>—Vents that allow for air circulation to cool the ventilator’s internal components. In addition, these openings function as sound ports for audible alarms. <b>WARNING:</b> Do not cover or obstruct these openings.</p>
<p><b>3 FiO<sub>2</sub> sensor connection</b>—Connection for FiO<sub>2</sub> sensor, which monitors the amount of oxygen in the patient circuit.</p>	<p><b>8 From patient port</b>—Exhaled volume measurements are taken from this port, through which a portion of the exhaled gas is diverted to the exhalation flow sensor. VTE is calculated from this flow measurement.<sup>1</sup></p>
<p><b>4 Patient connection port</b>—Provides an outlet for the gas to be delivered to the patient via the patient circuit.</p>	<p><b>9 Exhaled gas outlet</b>—Exhalation valve connects here.</p>
<p><b>5 Patient pressure monitoring port</b>—Nipple for monitoring proximal patient pressure.</p>	

1. If exhaled tidal volume monitoring is required, use the double-limb circuit.

## 2.6 Back Panel

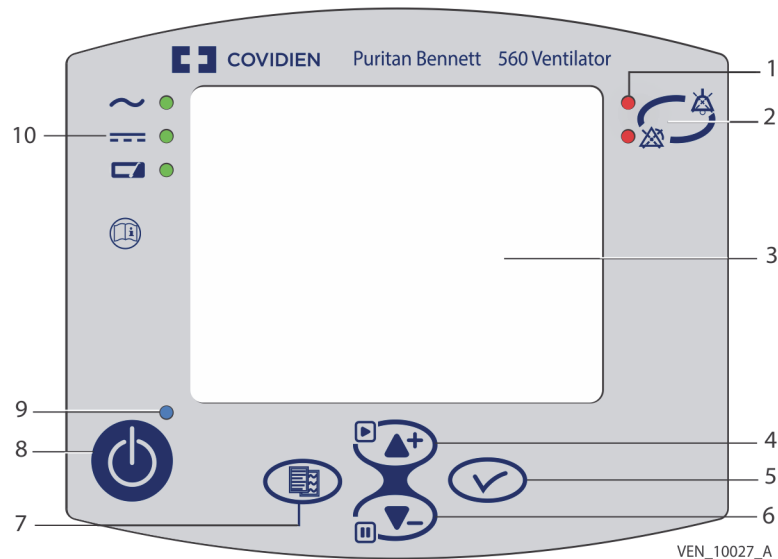
Figure 2-2. Back Panel



<p><b>1</b> Ergonomic carrying handle.</p>	<p><b>7</b> PC cable connector: USB mini-B connector used for Puritan Bennett™ ventilator test software. <b>WARNING:</b> Do not connect the ventilator to any device other than a PC with a dedicated compatible Puritan Bennett™ software package.</p>
<p><b>2</b> I/O (power) switch with protective cover: Device powered on in position I; device switched off in position 0.</p>	<p><b>8</b> O<sub>2</sub> inlet port: Connects the ventilator to a low pressure oxygen source via an adapter connected to the O<sub>2</sub> inlet (see <i>Oxygen</i> on page 6-21).</p>
<p><b>3</b> AC power (mains) cable connector.</p>	<p><b>9</b> Nurse call output connector: Used to connect the ventilator to the nurse call system.</p>
<p><b>4</b> AC power (mains) cable holding system: Secures AC power cable to avoid accidental disconnection.</p>	<p><b>10</b> USB memory device connection: USB connection to be used with the Puritan Bennett™ Respiratory Insight software package. There are two USB type A ports. <b>WARNING:</b> USB connections are not intended for connection to any devices other than the specified USB flash storage (see section 7.7.1, <i>USB Memory Device Specifications</i>).</p>
<p><b>5</b> Access cover for the internal battery.</p>	<p><b>11</b> Air inlet filter: Filters air as it enters the ventilator.</p>
<p><b>6</b> DC power cable connector with key.</p>	

## 2.7 Control Panel

Figure 2-3. Control Panel



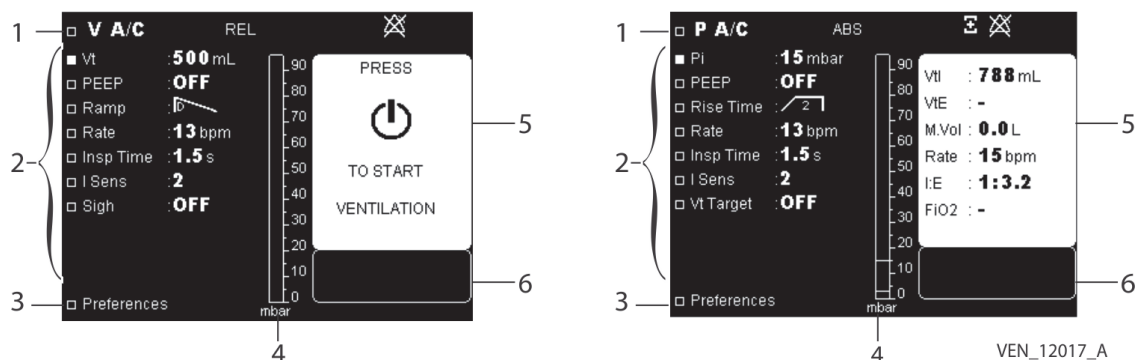
VEN\_10027\_A

<p><b>1</b> Alarm indicators (two LEDs):</p> <p>Red indicator:</p> <ul style="list-style-type: none"> <li>• Continuous: Very high priority (VHP) alarm activated.</li> <li>• Flashing: High priority (HP) alarm activated.</li> </ul> <p>Yellow indicator:</p> <ul style="list-style-type: none"> <li>• Flashing: Medium priority (MP) alarm activated.</li> <li>• Continuous: Low priority (LP) alarm activated.</li> </ul>	<p><b>6</b> DOWN/FREEZE key:</p> <ul style="list-style-type: none"> <li>• Moves the cursor down and decreases parameter values.</li> <li>• During ventilation, freezes the waveform shown in the Waveform menu.</li> </ul>
<p><b>2</b> ALARM CONTROL key:</p> <ul style="list-style-type: none"> <li>• Press once to pause an audible alarm for 60 seconds.</li> <li>• Press twice to halt visual and audible alarms. If alarm is remedied, the alarm is canceled (other than the high pressure alarm).</li> </ul>	<p><b>7</b> MENU key:</p> <p>Changes the menu shown. From the Ventilation menu screen, press this key to show the Alarm menu screen.</p> <p>When a USB memory device is inserted into the ventilator, press this key to show the USB memory device screen.</p>
<p><b>3</b> Display screen:</p> <p>Shows modes, ventilation settings, patient data and waveforms, configuration of the ventilator, and alarm management.</p>	<p><b>8</b> VENTILATION ON/OFF button:</p> <ul style="list-style-type: none"> <li>• ON: Press briefly and release to start ventilation.</li> <li>• OFF: Press and hold for 3 seconds, then press again to stop ventilation.</li> </ul>
<p><b>4</b> UP/UNFREEZE key:</p> <ul style="list-style-type: none"> <li>• Moves the cursor up and increases parameter values.</li> <li>• During ventilation, reactivates waveform tracing in the Waveform menu.</li> </ul>	<p><b>9</b> Ventilation status indicator:</p> <ul style="list-style-type: none"> <li>• Blue indicator illuminated: Device is turned on and ventilation is off (on standby).</li> <li>• Blue indicator off: Ventilation is on.</li> </ul>
<p><b>5</b> ENTER key:</p> <ul style="list-style-type: none"> <li>• Access to a setting value and validation of the modification of this setting.</li> <li>• Access to a sub-menu.</li> </ul>	<p><b>10</b> Electrical power source indicators:</p> <ul style="list-style-type: none"> <li>• AC power indicator lit: AC power source connected.</li> <li>• DC power indicator lit: DC power source connected.</li> <li>• Internal battery indicator lit continuously: Internal battery in use (no external power source connected.)</li> <li>• Internal battery indicator flashing: Battery charging.</li> </ul>



## 2.8 Ventilation Menu

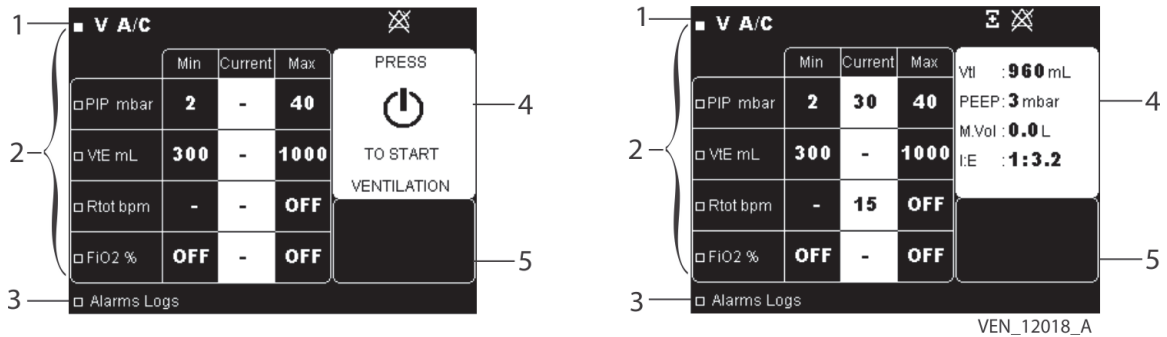
Figure 2-4. Ventilation Menu Display (on standby at left; during ventilation at right)



<p><b>1</b> General information line: Shows the current ventilation mode, along with the following:</p> <ul style="list-style-type: none"> <li>: Battery symbol if the device is powered by the internal battery.</li> <li>: Audio paused symbol if an alarm is currently inhibited.</li> <li>: Alarm canceled symbol if an alarm has been canceled manually and the cause of the alarm remains.</li> <li>: Apnea alarm deactivation symbol.</li> <li>: Exhalation valve symbol.</li> <li>: No exhalation valve symbol.</li> <li><b>ABS</b>: Absolute symbol.</li> <li><b>REL</b>: Relative symbol.</li> </ul>	<p><b>2</b> Ventilation settings: Shows the specific ventilation parameter values for the currently selected ventilation mode. See Chapter 3, <i>Operating Parameters</i> for more information.</p>	<p><b>3</b> Preferences menu access line: Highlight this line and press the ENTER  key to show the Preferences menu. See <i>Preferences Menu Parameters</i> on page 7-14 for more information.</p>
<p><b>4</b> Bargraph: Shows pressure generation during ventilation.</p>	<p><b>5</b> Status/monitored data window:</p> <ul style="list-style-type: none"> <li>• Ventilation stopped (standby): Shows the message, "PRESS  TO START VENTILATION."</li> <li>• Ventilation on: Parameters are monitored and shown.</li> <li>• The Inspiratory effort detected symbol  appears adjacent to the monitored I:E ratio when the patient actively triggers a breath.</li> </ul>	<p><b>6</b> Alarm conditions window:</p> <ul style="list-style-type: none"> <li>• For active alarms, scrolls through active alarm messages in flashing reverse video.</li> <li>• For inactive alarms, shows the last alarm along with its trigger date and end-of-event time. See Chapter 5, <i>Alarms and Troubleshooting</i> for details.</li> </ul>

## 2.9 Alarm Menu

Figure 2-5. Alarm Menu (on standby at left; during ventilation at right)



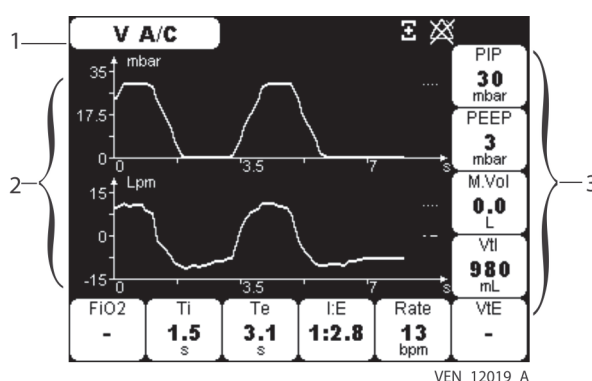
<p><b>1</b> Title line: Shows ventilation mode and the following symbols:</p> <p>: Battery symbol if the ventilator is powered by the internal battery.</p> <p>: Audio paused symbol if an alarm is currently inhibited.</p> <p>: Alarm paused symbol if an alarm has been canceled manually and the cause of the alarm remains.</p> <p>: Apnea alarm deactivation symbol.</p> <p>: Exhalation valve symbol.</p> <p>: No exhalation valve symbol.</p>	<p><b>2</b> Alarm settings: Shows the specific alarm parameter values for the currently selected ventilation mode, which are:</p> <ul style="list-style-type: none"> <li>• Minimum and maximum alarm threshold settings</li> <li>• Current monitored patient readings, or hyphen (-) when ventilation is in standby</li> </ul>	<p><b>3</b> Access line to Alarm Logs menu. Highlight this line and press the ENTER  key to show the Alarm Logs menu. See <a href="#">Alarm Logs Menu</a> on page 5-4.</p>
<p><b>4</b> Status/monitored data window:</p> <ul style="list-style-type: none"> <li>• Ventilation stopped (standby): Shows the message, "PRESS  TO START VENTILATION."</li> <li>• Ventilation on: Parameters are monitored and shown.</li> <li>• The Inspiratory effort detected symbol  appears adjacent to the monitored I:E ratio when the patient actively triggers a breath.</li> </ul>	<p><b>5</b> Alarm message window:</p> <ul style="list-style-type: none"> <li>• For active alarms, scrolls through active alarm messages in flashing reverse video.</li> <li>• For inactive alarms, shows the last alarm along with its trigger date and end-of-event time. See Chapter 5, <a href="#">Alarms and Troubleshooting</a> for more information.</li> </ul>	








## 2.10 Waveforms Menu

-  The display of waveforms (see Figure 2-6) is optional and can be selected using the Menu key (see Chapter 4, *Monitored Parameters*).

The Waveform menu is only accessible when ventilation is active.

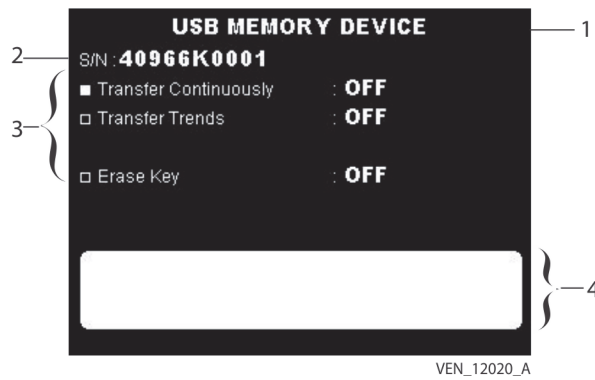
Figure 2-6. Waveforms Menu



<p><b>1</b> Title line: Shows ventilation mode and the following symbols:</p> <p>: Battery symbol if the ventilator is powered by the internal battery.</p> <p>: Audio paused symbol if an alarm is currently inhibited.</p> <p>: Alarm paused symbol if an alarm has been canceled manually and the cause of the alarm remains.</p> <p>: Apnea alarm deactivation symbol.</p> <p>: Freeze waveforms symbol if the tracing of patient waveforms has been halted during ventilation.</p> <p>: Exhalation valve symbol.</p> <p>: No exhalation valve symbol.</p>	<p><b>2</b> Graphic zone: Shows the patient's pressure and flow waveforms as a function of time. For more information, see Chapter 4, <i>Monitored Parameters</i>.</p>	<p><b>3</b> Numeric zone: Shows monitored data.</p>
---	--	---

## 2.11 USB Memory Device Menu

Figure 2-7. USB Memory Device Menu



- 1 Title line
- 2 Ventilator serial number
- 3 USB Memory Device menu
- 4 Dialogue box

## 2.12 If Ventilator Failure Occurs

If a problem with the ventilator is suspected, **first check that the patient is not in danger**. If necessary, remove the patient from the ventilator and provide an alternate means of ventilation.

Keep in mind that troubleshooting information is available in this manual to assist you in the event of a problem. See Chapter 5, *Alarms and Troubleshooting*.

If you cannot determine the cause of a problem, contact your equipment supplier or Covidien. See section 10.7, *Service Assistance*.

# 3 Operating Parameters

## 3.1 Overview

This chapter describes ventilation and alarm parameters and their setting ranges for each ventilation mode. For a listing of operating parameters and monitored patient data, see Table [B-12](#) on page [B-9](#). For further information about the different ventilation modes and breath types provided by the Puritan Bennett™ 560 ventilator, see Appendix [D, Modes and Breath Types](#).



**WARNING:**

The ventilator offers a variety of breath delivery options. Throughout the patient's treatment, the clinician should carefully select the ventilation mode and settings to use for that patient, based on clinical judgment, the condition and needs of the patient, and the benefits, limitations, and characteristics of the breath delivery options. As the patient's condition changes over time, periodically assess the chosen modes and settings to determine whether those are best for the patient's current needs.



**WARNING:**

Setting any alarm limits to OFF or extreme high or low values can cause the associated alarm not to activate during ventilation, which reduces its efficacy for monitoring the patient and alerting the clinician to situations that may require intervention.



**WARNING:**

If Apnea Time is set to a value higher than 60/Rate then the Apnea alarm will not activate.



**WARNING:**

The Min PIP alarm setting must be adjusted for the patient, but must also be set high enough to allow the Patient Disconnection alarm to trigger properly. Perform the low pressure test (see section [F.1, Low Pressure Test](#)) to ensure that the alarm is properly set.



**WARNING:**

The Max Leak alarm setting must be adjusted for the patient, but must also be set low enough to allow the High Leakage alarm to trigger properly. Perform the max leak test (refer to section [F.2, Max Leak Test \(Only NIV\)](#)) to ensure that the alarm is properly set. This alarm only applies to leak configuration (NIV).

### 3.2 PSV Mode Parameters and Setting Ranges

The menus for PSV—Pressure Support Ventilation mode are shown in Figures 3-1 and 3-2.

Figure 3-1. Menus in PSV Mode with Exhalation Valve Configuration

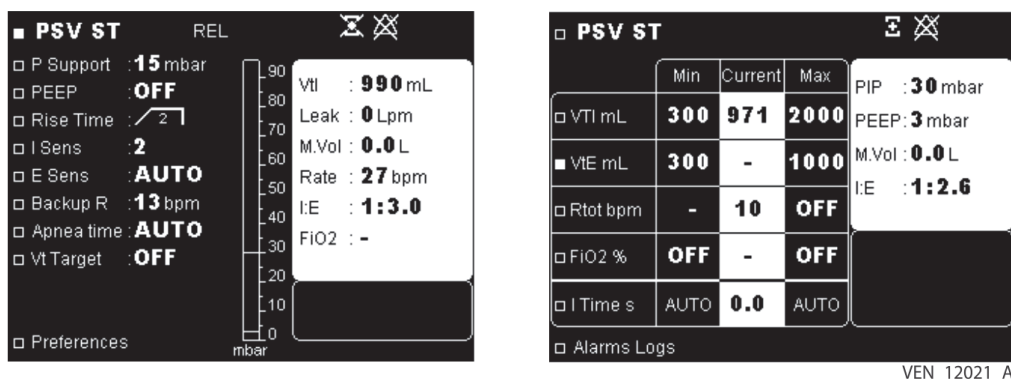
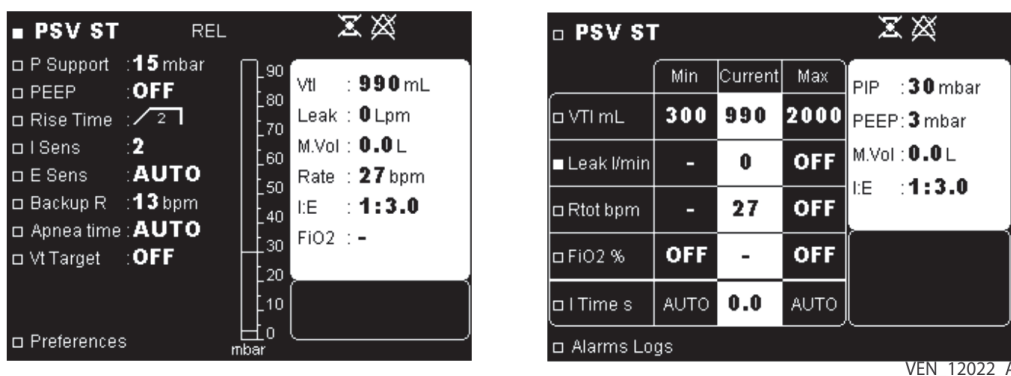


Figure 3-2. Menus in PSV Mode with Leakage Configuration



The ventilation parameters and setting ranges available in PSV mode are listed in [Table 3-1](#).

Table 3-1. Ventilation Parameters in PSV Menu

Name	Units	Min. value	Max. value	Adjustment resolution	Default value	Linked parameters
P Support	cmH <sub>2</sub> O, mbar, or hPa	Standby: 2 Valve configuration: 5 Leak configuration: 6	Standby: 55 Valve configuration: 55 Leak configuration: 30	1	15	PEEP
PEEP	cmH <sub>2</sub> O, mbar, or hPa	Standby: OFF Valve configuration: OFF Leak configuration: 4	20	1	OFF	P Support Max P
Rise Time	–	1	4	1	2	I Time
I Sens	–	0P	5	1	2	–
E Sens <sup>1</sup>	%	5 (–95)	95 (–5)	5	Auto	–
Backup R	bpm	4	40	1	13	Min I Time
Apnea Time	s	1	60	1	Auto	Backup R

**Table 3-1.** Ventilation Parameters in PSV Menu

Name	Units	Min. value	Max. value	Adjustment resolution	Default value	Linked parameters
Vt Target	ml	50	2000	10	OFF = 100	–
Min I Time	s	0.1	2.8	0.1	Auto	Max I Time
Max P	mbar	8	55	1	Pi + 3	–
Max I Time	s	0.8	3	0.1	Auto	Min I Time

1. See Chapter 7, *Operating Procedures* for information on positive and negative E Sens settings.

Table 3-2 lists the available alarm settings in PSV mode.

**Table 3-2.** Alarm Parameters in PSV Mode

Name	Units	Min. value	Max. value	Adjustment resolution	Default value	Linked parameters
Min VTI	ml	30	2000	10	300	Max VTI
Max VTI	ml	80	3000	10	2000	Min VTI
Min VTE (with exhalation valve)	ml	30	1990	10	300	Max VTE
Max VTE (with exhalation valve)	ml	80	3000	10	1000	Min VTI
Max Leak (with leak configuration)	lpm	5	150	5	OFF	–
Max Rtot	bpm	10	70	1	OFF	Backup R
Min FiO <sub>2</sub>	%	18	90	1	OFF	Max FiO <sub>2</sub>
Max FiO <sub>2</sub>	%	30	100	1	OFF	Min FiO <sub>2</sub>

### 3.2.1 P Support—Pressure Support

When Relative pressure is set to YES in the Setup menu, P Support allows you to determine inspiratory pressure added to PEEP during the inspiratory phase.

In this configuration, the sum of P Support and PEEP must not exceed 55 mbar.

When Relative pressure is set to OFF in the Setup menu, P Support allows you to determine inspiratory absolute pressure.

In this configuration, P Support and PEEP are related and their settings must maintain a minimum difference between the two of 2 mbar in leak configuration and 5 mbar in valve configuration.

### 3.2.2 PEEP—Positive End Expiratory Pressure

PEEP allows you to determine the level of pressure maintained during the exhalation phase.

When Relative pressure is set to YES in the Setup menu, the sum of P Support and PEEP must not exceed 55 mbar.

When relative pressure is set to OFF, P Support and PEEP are related and their settings must maintain a minimum difference between the two of 2 mbar in leak configuration and 5 mbar in valve configuration.





The ventilation mode can be adjusted without PEEP (PEEP is nearly 0 mbar when set to OFF) in valve configuration.

In leak configuration, the minimum PEEP setting is 4 mbar.

### 3.2.3 Rise Time

This parameter is used during the inspiration phase to determine how the target pressure will be reached. This setting indirectly defines the minimum inspiratory time.

The different levels available are as follows:

-  1 • Rise time 1 = 200 ms
-  2 • Rise time 2 = 400 ms
-  3 • Rise time 3 = 600 ms
-  4 • Rise time 4 = 800 ms

These time ranges are determined by the pressure setting required, the breath rate, and the physiological condition of the patient.

### 3.2.4 I Sens—Inspiratory Trigger Sensitivity

I Sens allows you to set the level of inspiratory effort the patient has to provide during the initiation of a machine breath.

The sensitivity levels are 0P, 1P, 2, 3, 4, and 5 (P denotes pediatric use); the lower the number, the more sensitive the trigger sensitivity.

I Sens can be set to OFF.



**WARNING:**

**Ensure that the I Sens setting is not set to OFF when ventilating patients capable of triggering spontaneous breaths.**



**WARNING:**

**Carefully modify the trigger threshold setting to reduce the risk of ventilator autotriggering. Level 0P, the most sensitive inspiratory trigger, is recommended for pediatric use. For an adult, this setting may result in ventilator autotriggering.**



### 3.2.5 E Sens—Exhalation Sensitivity

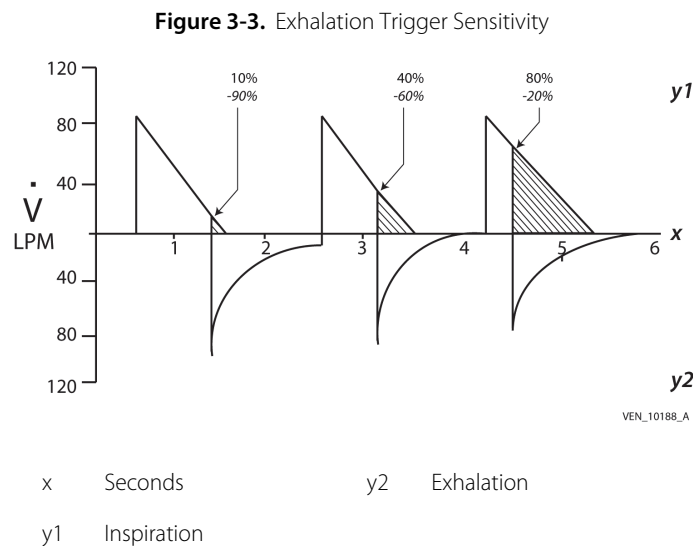
E Sens is available in the PSIMV, VSIMV, and PSV modes.

E Sens allows you to determine sensitivity of switching to exhalation and thus indirectly determines the inspiratory time of a breath.

The end of inspiration will occur when inspiratory flow has decreased to the preset E Sens setting.

The exhalation trigger is only taken into account after the Rise Time (which constitutes a default minimum inspiratory time) has elapsed.

If the flow drop is insufficient, exhalation is automatically triggered independently of the E Sens, which is defined as a percentage of peak inspiratory flow. Exhalation may be triggered if the maximum inspiratory time has elapsed. For more information about maximum inspiratory time, see section 3.2.10, *Min and Max I Time—Minimum and Maximum Inspiration Time*.



#### Note:

See section 7.2.2, *Changing the Setup Menu Parameters* for positive and negative E Sens settings.

### 3.2.6 Backup R—Backup Rate

Backup R allows you to determine the frequency of ventilation breaths to be applied in the event of prolonged apnea – as long as no inspiratory trigger is detected.

The inspiratory time of the backup breaths applied in the event of apnea still depends on the detection of exhalation trigger (E Sens) and the safety maximum inspiratory time (see above comment on E Sens). The rise time of these cycles is identical to the ventilation cycle previously set.

The controlled cycles following apnea are interrupted as soon as a new spontaneous inspiration of the patient is detected.

The Backup R is linked to the Min I Time so that the Min I Time setting cannot be greater than half the inspiratory phase of a ventilator-controlled breath.

Backup R breath is delivered at the Pressure Support settings.

Setting a backup rate is not optional; it is always set.

### 3.2.7 Apnea Time

Apnea time allows the user to monitor and detect interruptions to the patient's spontaneous breathing pattern. The ventilator declares apnea when no breath has been delivered by the time that the operator-selected apnea interval elapses.

The Apnea time adjustment range shall be 1 to 60 seconds. The ventilator shall enable the operator to set an auto-setting. The Apnea time AUTO setting (in seconds) is calculated using the formula (Auto = maximum value between 3 seconds and  $60/\text{Backup R}$  or  $\text{AUTO}=30$  in CPAP mode).



**Note:**

During apnea ventilation, the ventilator delivers machine controlled breaths according to a backup rate (Backup R)—as long as no inspiratory trigger has been detected.



**Note:**

The Backup R value applied depends on the Rate setting.



**Note:**

If the Apnea alarm is set to OFF in the Preferences menu, the Apnea time setting will still be active.

### 3.2.8 Vt Target—Target Tidal Volume

Vt Target allows the ventilator to deliver a target volume of gas to the patient.

When a Vt Target is set, the ventilator constantly adjusts the target inspiratory pressure between Pi and Max P to ensure the inspired tidal volume remains as close as possible to the Vt target.

Vt Target should be more than 10 ml higher than Min VTE and more than 10 ml lower than Max VTl to avoid triggering VTI or VTE alarms.

The minimum increase or decrease of target inspiratory pressure is 0.5 mbar and the maximum is 2 mbar.

Setting the Vt Target is not mandatory (it can be set to OFF).

### 3.2.9 Max P—Maximum Inspiration Pressure

Max P allows the ventilator to adjust the inspiratory pressure up to a maximum limit in order to reach the target tidal volume (Vt Target).

P Support and Max P are related and the difference between them must be less than 20 mbar.

Max P is not shown when Vt Target is set to OFF.

### 3.2.10 Min and Max I Time—Minimum and Maximum Inspiration Time

Min I Time and Max I Time are ventilation parameters that can be adjusted in the alarm menu.

Min I Time defines the minimum duration of time the inspiratory phase is maintained. It takes priority over activation of the exhalation trigger which can only be triggered after the Min I Time has expired.

The Backup R is linked to the Min I Time so that the Min I Time setting cannot be greater than half the inspiratory phase of a cycle triggered by the ventilator.

If Backup R is changed, Min I Time is, if necessary, automatically readjusted so that the difference between them is always maintained.

The minimum time by default if no parameter is set (Min I Time = AUTO) corresponds to the Rise Time to which an operating margin of 0.3 seconds is added. See *Rise Time* on page 3-4 for details about Rise Time.

Max I Time defines the maximum duration of time during which the inspiratory phase is maintained. The switch-over to exhalation occurs, at the latest, after this time has expired.

By default, if no parameter is set, the maximum time (Max I Time = AUTO) is the shortest time between a fixed time of 3 seconds and half the duration of the patient's inspiratory breaths expressed in seconds. (AUTO equals the lesser of 3 seconds or 30/Rate). This default value will be applied if it is lower than the Max I Time setting.

Min I Time and Max I Time are related so that the Max I Time cannot be set to a value lower than the Min I Time.

### 3.2.11 Min and Max VTI—Minimum and Maximum Inspiratory Tidal Volume

It is possible to set a minimum, maximum, or both Tidal Volume alarm threshold for the patient's inspired tidal volume during a cycle.

This setting is used to trigger an alarm if the tidal volume inspired by the patient is lower than the minimum threshold set (Low VTI alarm) or greater than the maximum threshold set (High VTI alarm). See Chapter 5, *Alarms and Troubleshooting*.

Min VTI and Max VTI are related, and their settings must be set to values that maintain a minimum difference of 20 ml between the two.

It is not mandatory to set the minimum and maximum VTI alarm limits. When the minimum and maximum VTI alarm limits are not set, the display will show "OFF" next to these settings.

### 3.2.12 Min and Max VTE—Minimum and Maximum Exhalation Tidal Volume

Use a double-limb patient circuit configuration when setting the minimum, maximum, or both Exhalation Tidal Volume alarm parameters.

These thresholds can be set to trigger an alarm if the tidal volume expired by the patient is lower than the minimum threshold set (Low VTE alarm) or greater than the maximum threshold set (High VTE alarm). See Chapter 5, *Alarms and Troubleshooting*.

Min VTE and Max VTE are related and their settings must be set to values that maintain a minimum difference of 20 ml between the two.

VTE is shown when ventilating with an exhalation valve.

It is not mandatory to set the minimum and maximum VTE alarm limits. When the minimum and maximum VTE alarm limits are not set, the display will show "OFF" next to these settings.

### 3.2.13 Max Leak—Maximum Leakage

The setting of a high leakage threshold enables a High Leakage alarm to be triggered in the event the calculated leakage flow exceeds this limit. The displayed value corresponds to the mean parasite leakage flow observed during the exhalation phase.

This alarm can be used to detect a circuit disconnect in leak configuration mode.

Max Leak is shown when ventilating without an exhalation valve.

Setting the Max Leak is not mandatory (it can be set to OFF), but the measured value is always shown.

### 3.2.14 Max Rtot—Maximum Total Breath Rate

The maximum rate threshold set is used to warn of hyperventilation or ventilator autotriggering.

The alarm setting is used to trigger the High Rate alarm. See Chapter 5, *Alarms and Troubleshooting*.

When set, the Max Rtot threshold must always exceed the backup rate by 5 bpm. If the backup rate is readjusted, the Max Rtot is automatically readjusted to maintain a minimum difference of 5 bpm.

Setting the Max Rtot is not mandatory (it can be set to OFF), but the measured value is always shown.

### 3.2.15 Min and Max FiO<sub>2</sub>—Minimum and Maximum Fraction of Inspired Oxygen

An FiO<sub>2</sub> sensor connected to the patient circuit allows you to determine that the correct level of oxygen is being delivered to the patient.

Min and Max FiO<sub>2</sub> thresholds can be set to trigger Low FiO<sub>2</sub> or High FiO<sub>2</sub> alarms.

Min FiO<sub>2</sub> and Max FiO<sub>2</sub> thresholds are related and their settings must maintain a minimum difference of 10% between the two.

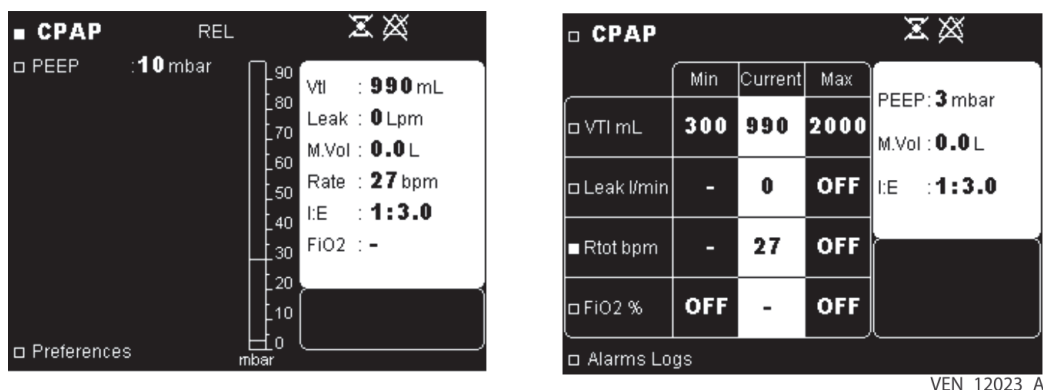
Min and Max FiO<sub>2</sub> settings can be set to OFF if an FiO<sub>2</sub> sensor is not connected. Settings are automatically restored once a sensor is reconnected.

These settings are the same for all ventilation modes.

### 3.3 CPAP Mode Parameters and Setting Ranges

The menus in CPAP (Continuous Positive Airway Pressure) ventilation mode are shown in [Figure 3-4](#).

**Figure 3-4.** Menus in CPAP Mode in leakage configuration



The ventilation parameters and setting ranges available in CPAP mode are listed in [Table 3-3](#).

**Table 3-3.** Ventilation Parameters in CPAP Menu

Name	Units	Min. value	Max. value	Adjustment resolution	Default value	Linked parameters
PEEP	cmH <sub>2</sub> O, mbar, or hPa	4	20	1	10	Pi
Apnea Time <sup>1</sup>	s	1	60	1	Auto	Backup R

1. Not available if Apnea alarm is set to OFF in Preferences menu.

Table 3-4 lists the available alarm settings in CPAP mode.

**Table 3-4.** Alarm Parameters in CPAP Mode

Name	Units	Min. value	Max. value	Adjustment resolution	Default value	Linked parameters
Min VTI	ml	30	2000	10	300	Max VTI
Max VTI	ml	80	3000	10	2000	Min VTI
Max Leak	lpm	5	150	5	OFF	-
Max Rtot	bpm	10	70	1	OFF	Backup R
Min FiO <sub>2</sub>	%	18	90	1	OFF	Max FiO <sub>2</sub>
Max FiO <sub>2</sub>	%	30	100	1	OFF	Min FiO <sub>2</sub>



**WARNING:**

The CPAP mode does not feature control cycles. Do not use this mode for ventilator-dependent patients.



**Note:**

Only leak configuration is available in CPAP mode.

### 3.3.1 PEEP—Positive End Expiratory Pressure

PEEP allows you to determine the level of pressure maintained during the exhalation phase.

The ventilation mode can be adjusted without PEEP (PEEP is nearly 0 mbar when set to OFF).

A PEEP value can be set to determine the level of pressure maintained during the inspiratory phase and the exhalation phase.

### 3.3.2 Apnea Time

Apnea time allows the user to monitor and detect interruptions to the patient's spontaneous breathing pattern. The ventilator declares apnea when no breath has been delivered by the time that the operator-selected apnea interval elapses.

The Apnea time AUTO setting is 30 seconds.

Apnea time is not available if Apnea alarm is set to OFF in the Preferences menu.

### 3.3.3 Min and Max VTI—Minimum and Maximum Inspiratory Tidal Volume

It is possible to set a Min, Max, or both Tidal Volume alarm threshold for the patient's inspired tidal volume during a cycle.

This setting is used to trigger an alarm if the tidal volume inspired by the patient is lower than the minimum threshold set (Low VTI alarm) or greater than the maximum threshold set (High VTI alarm). See Chapter 5, *Alarms and Troubleshooting*.

Min VTI and Max VTI are related, and their settings must be set to values that maintain a minimum difference of 20 ml between the two.

It is not mandatory to set the minimum and maximum VTI alarm limits. When the minimum and maximum VTI alarm limits are not set, the display will show "OFF" next to these settings.

### 3.3.4 Max Leak—Maximum Leakage

The setting of a high leakage threshold enables a High Leakage alarm to be triggered in the event the calculated leakage flow exceeds this limit. The displayed value corresponds to the mean parasite leakage flow observed during the exhalation phase.

This alarm can be used to detect a circuit disconnect in leak configuration mode.

It is not mandatory to set the maximum Leak alarm limit. When the maximum Leak alarm limit is not set, the display will show "OFF" next to this setting.

### 3.3.5 Max Rtot—Maximum Total Breath Rate

The maximum rate threshold set is used to warn of hyperventilation or ventilator autotriggering. The alarm setting is used to trigger the High Rate alarm. See Chapter 5, *Alarms and Troubleshooting*. When set, the Max Rtot threshold must always exceed the backup Rate by 5 bpm. If the backup rate is readjusted, the Max Rtot is automatically readjusted to maintain a minimum difference of 5 bpm. Setting the Max Rtot is not mandatory (it can be set to OFF), but the measured value is always shown.

### 3.3.6 I Sens—Inspiratory Trigger Sensitivity

The trigger threshold for switching to inhalation cannot be set in CPAP mode. The device is configured with a default I Sens of 2.

### 3.3.7 E Sens—Exhalation Trigger Sensitivity

The trigger threshold for switching to exhalation cannot be set in CPAP mode. The device is configured with a default E Sens of 25%.

### 3.3.8 Min and Max FiO<sub>2</sub>—Minimum and Maximum Fraction of Inspired Oxygen

An FiO<sub>2</sub> sensor connected to the patient circuit allows you to determine that the correct level of oxygen is being delivered to the patient.

Min and Max FiO<sub>2</sub> thresholds can be set to trigger Low FiO<sub>2</sub> or High FiO<sub>2</sub> alarms.

Min FiO<sub>2</sub> and Max FiO<sub>2</sub> thresholds are related and their settings must maintain a minimum difference of 10% between the two.

Min and Max FiO<sub>2</sub> settings can be set to OFF if an FiO<sub>2</sub> sensor is not connected. Settings are automatically restored once a sensor is reconnected.

These settings are the same for all ventilation modes.

### 3.4 P A/C Mode Parameters and Setting Ranges

The menus in P A/C (Pressure Assisted/Controlled) ventilation mode are shown in Figures 3-5 and 3-6.

Figure 3-5. Menus in P A/C Mode with Exhalation Valve Configuration

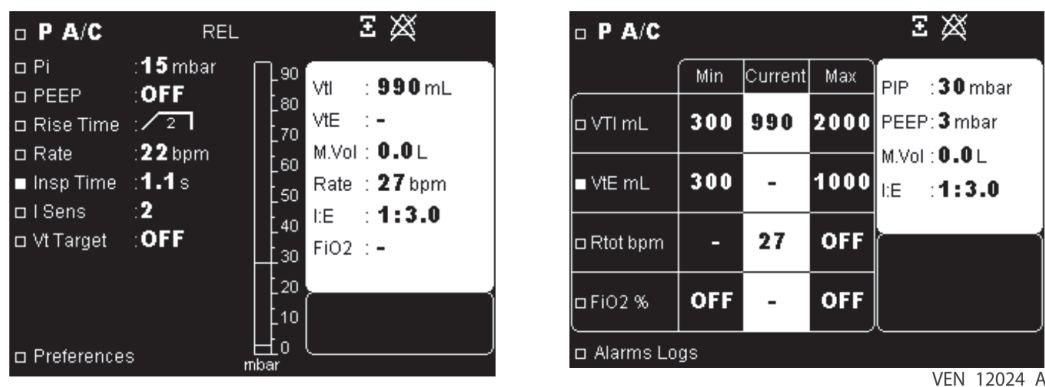
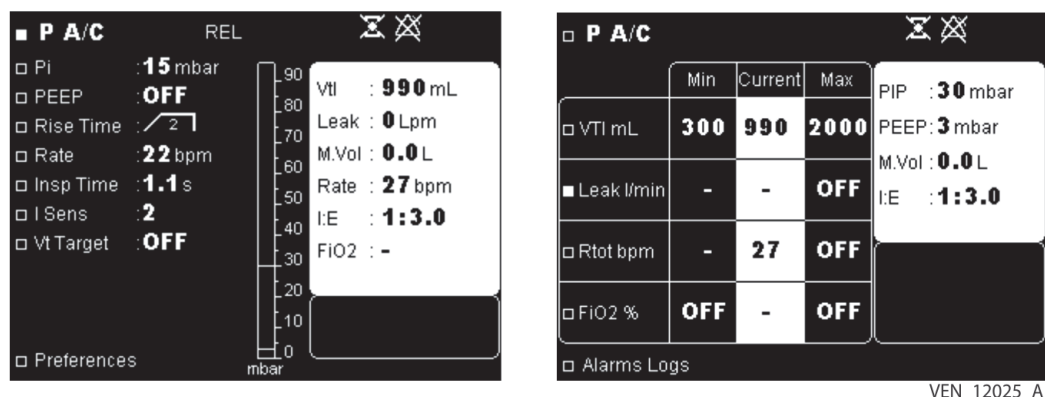


Figure 3-6. Menus in P A/C Mode with Leakage Configuration



The ventilation parameters adjustable in P A/C mode are listed in Table 3-5.

Table 3-5. Ventilation Parameters in PA/C Mode Menu

Name	Units	Min. value	Max. value	Adjustment resolution	Default value	Linked parameters
Pi	cmH <sub>2</sub> O, mbar, or hPa	Standby: 2 Valve configuration: 5 Leak configuration: 6	Standby: 55 Valve configuration: 55 Leak configuration: 30	1	15	PEEP
PEEP	cmH <sub>2</sub> O, mbar, or hPa	Standby: OFF Valve configuration: OFF Leak configuration: 4	20	1	OFF	Pi
Rise Time	-	1	4	1	2	Rate I/T
Rate	bpm	1	60	1	13	Max Rtot



**Table 3-5.** Ventilation Parameters in PA/C Mode Menu (Continued)

Name	Units	Min. value	Max. value	Adjustment resolution	Default value	Linked parameters
Insp Time	s	0.3	6.0	0.1	1.5	Rate Vt Apnea Time
I Sens	–	OFF	5	1	2	–
Vt Target	ml	50	2000	10	OFF	Min VTE Max VTE Min VTI Max VTI
Max P	cmH <sub>2</sub> O, mbar, or hPa	8	55	1	Pi + 3	Pi PEEP

Table 3-6 lists the adjustable alarm parameters in P A/C mode.

**Table 3-6.** Alarm Parameters in PA/C Mode

Name	Units	Min. value	Max. value	Adjustment resolution	Default value	Linked parameters
Min VTI	ml	30	2000	10	300	Max VTI
Max VTI	ml	80	3000	10	2000	Min VTI
Min VTE (with exhalation valve)	ml	30	1990	10	300	Max VTE
Max VTE (with exhalation valve)	ml	80	3000	10	1000	Min VTE
Max Leak (leakage configuration)	ml	5	150	5	OFF	–
Max Rtot	bpm	10	70	1	OFF	Rate
Min FiO <sub>2</sub>	%	18	90	1	OFF	Max FiO <sub>2</sub>
Max FiO <sub>2</sub>	%	30	100	1	OFF	Min FiO <sub>2</sub>

### 3.4.1 Pi—Inspiratory Pressure

When Relative pressure is set to YES in the Setup menu, Pi allows you to determine inspiratory pressure added to PEEP during the inspiratory phase.

In this configuration, the sum of Pi and PEEP must not exceed 55 mbar.

When Relative pressure is set to OFF in the Setup menu, Pi allows you to determine inspiratory absolute pressure.

In this configuration, Pi and PEEP are related and their settings must maintain a minimum difference between the two of 2 mbar in leak configuration and 5 mbar in valve configuration.

### 3.4.2 PEEP—Positive End Expiratory Pressure

PEEP allows you to determine the level of pressure maintained during the exhalation phase.

When Relative pressure is set to YES in the Setup menu, the sum of  $P_i$  and PEEP must not exceed 55 mbar.

When relative pressure is set to OFF,  $P_i$  and PEEP are related and their settings must maintain a minimum difference between the two of 2 mbar in leak configuration and 5 mbar in valve configuration.





The ventilation mode can be adjusted without PEEP (PEEP is nearly 0 mbar when set to OFF) in valve configuration.

In leak configuration, the minimum PEEP setting is 4 mbar.

### 3.4.3 Rise Time





This parameter is used during the inspiration phase to adjust how the pressure setpoint will be reached. This setting indirectly defines the minimum inspiratory time.

The different levels available are as follows:

-  • Rise time 1 = 200 ms
-  • Rise time 2 = 400 ms
-  • Rise time 3 = 600 ms
-  • Rise time 4 = 800 ms

These time ranges are determined by the combination of the pressure setting required, the breath rate and the physiological conditions of the patient.

The pressure rise time built-up at each cycle depends on the inspiratory time corresponding to the combination of the rate setting and the Insp Time setting.

-  • Rise Time 1 is always possible
-  • Rise Time 2 is established only if Insp Time  $\geq 0.7$  seconds
-  • Rise Time 3 is established only if Insp Time  $\geq 0.9$  seconds
-  • Rise Time 4 is established only if Insp Time  $\geq 1.1$  seconds

### 3.4.4 Rate—Respiratory Rate

Rate allows you to define the minimal frequency of mandatory ventilator breaths.

If the patient actuates the inspiration trigger, total Rate may increase.

### 3.4.5 Insp Time—Inspiratory Time

This parameter allows the user to set the inspiratory time to 0.3-6.0 s. When changing Insp Time, the ventilator shows the corresponding I:E ratio or I/T% in the settings window. The maximum I:E setting is constrained to 1:1.

### 3.4.6 I Sens—Inspiratory Trigger Sensitivity

I Sens allows you to set the level of inspiratory effort the patient has to provide to initiate a machine breath.

The sensitivity levels are 0P, 1P, 2, 3, 4, and 5 (P denotes pediatric use); the lower the number, the more sensitive the trigger sensitivity.

I Sens can be set to OFF.



**WARNING:**

**The inspiration trigger threshold should be carefully modified in order to avoid the risk of false triggering or “autotriggering” of the ventilator. For example, Level 0P, the most sensitive mode, is recommended for pediatric use. However, for an adult, this setting may result in autotriggering.**

### 3.4.7 Vt Target—Target Tidal Volume

Vt Target allows the ventilator to deliver a target volume of air to the patient.

When a Vt Target is set, the ventilator constantly adjusts the target inspiratory pressure between Pi and Max P to ensure the inspired tidal volume remains as close as possible to the Vt target.

Vt Target should be more than 10 ml higher than Min VTE and more than 10 ml lower than Max VTI to avoid triggering VTI or VTE alarms.

The minimum increase or decrease of target inspiratory pressure is 0.5 mbar and the maximum is 2 mbar.

Setting the Vt Target is not mandatory (it can be set to OFF).

### 3.4.8 Max P—Maximum Inspiration Pressure

Max P allows the ventilator to adjust the inspiratory pressure up to a maximum limit in order to reach the target tidal volume (Vt Target).

Pi and Max P are related and the difference between them must be less than 20 mbar.

Max P is not shown when Vt Target is set to OFF.

### 3.4.9 Min and Max VTI—Minimum and Maximum Inspiratory Tidal Volume

It is possible to set a Min, Max, or both Tidal Volume alarm threshold for the patient's inspired tidal volume during a cycle.

This setting is used to trigger an alarm if the tidal volume inspired by the patient is lower than the minimum threshold set (Low VTI alarm), or greater than the maximum threshold set (High VTI alarm). See Chapter 5, *Alarms and Troubleshooting*.

Min VTI and Max VTI are related and their settings must be set to values that maintain a minimum difference of 20 ml between the two.

It is not mandatory to set the minimum and maximum VTI alarm limits. When the minimum and maximum VTI alarm limits are not set, the display will show "OFF" next to these settings.

### 3.4.10 Min and Max VTE—Minimum and Maximum Exhalation Tidal Volume

A Min, Max, or both Tidal Volume Expired by the patient alarm threshold can always be set but can only be used in a double-limb circuit configuration.

These thresholds can be set to trigger an alarm if the tidal volume expired by the patient is lower than the minimum threshold set (Low VTE alarm) or greater than the maximum threshold set (High VTE alarm). See Chapter 5, *Alarms and Troubleshooting*.

Min VTE and Max VTE are related and their settings must be set to values that maintain a minimum difference of 20 ml between the two.

VTE is shown when ventilating with an exhalation valve.

Setting Min VTE and Max VTE is not mandatory (they can be set to OFF), but the display of the measured value is always active in double-limb configuration.

### 3.4.11 Max Leak—Maximum Leakage

The setting of a high leakage threshold enables a High Leakage alarm to be triggered in the event the calculated leakage flow exceeds this limit. The displayed value corresponds to the mean parasite leakage flow observed during the exhalation phase.

### 3.4.12 Max Rtot—Maximum Total Breath Rate

The maximum rate threshold setting is used to warn of hyperventilation or autotriggering of the ventilator. This setting is used to trigger the High Rate alarm. See Chapter 5, *Alarms and Troubleshooting*.

The Max Rtot threshold must always be set at least 5 bpm higher than the Rate. If the Rate is readjusted, the Max Rtot is automatically readjusted to maintain a minimum difference of 5 bpm.

Setting the Max Rtot is not mandatory (it can be set to OFF), but the measured value is always shown.

### 3.4.13 Min and Max FiO<sub>2</sub>—Minimum and Maximum Fraction of Inspired Oxygen

An FiO<sub>2</sub> sensor connected to the patient circuit allows you to determine that the correct level of oxygen is being delivered to the patient.

Min and Max FiO<sub>2</sub> thresholds can be set to trigger Low FiO<sub>2</sub> or High FiO<sub>2</sub> alarms.

Min and Max FiO<sub>2</sub> thresholds are related and their settings must maintain a minimum difference of 10% between the two.

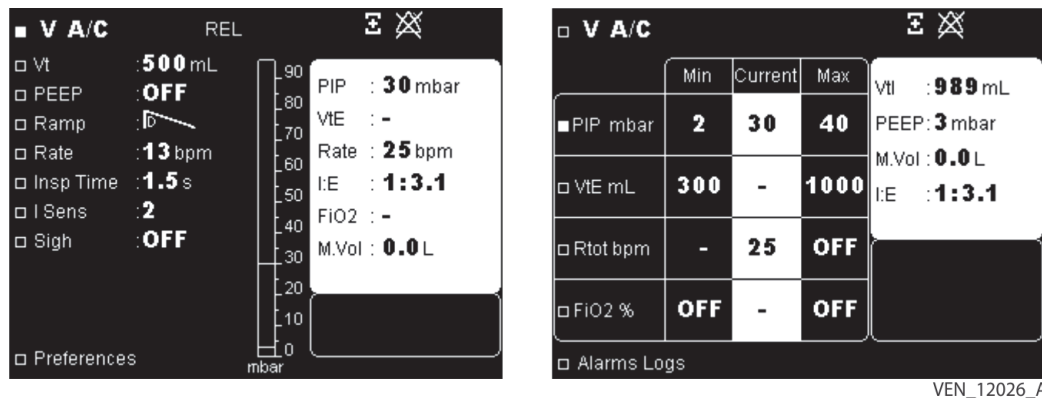
Min and Max FiO<sub>2</sub> settings can be set to OFF if an FiO<sub>2</sub> sensor is not connected. Settings are automatically restored once a sensor is reconnected.

These settings are the same for all ventilation modes.

## 3.5 V A/C Mode Parameters and Setting Ranges

The menus in the V A/C (Volume Assisted/Controlled) ventilation mode are shown in [Figure 3-7](#).

**Figure 3-7.** Menus in the V A/C Mode



VEN\_12026\_A

The ventilation parameters that are adjustable in the V A/C mode are shown in [Table 3-7](#).

**Table 3-7.** Ventilation Parameters in V A/C Ventilation Mode

Name	Units	Min. value	Max. value	Adjustment resolution	Default value	Linked parameters
Vt	ml	50	2000	10	500	Rate Min VTE Max VTE Vt Sigh
PEEP	cmH <sub>2</sub> O, mbar, or hPa	OFF	20	1	OFF	Min PIP Max PIP
Ramp Pattern	–	D	SQ	–	D	–
Rate	bpm	1	60	1	13	Max Rtot

**Table 3-7.** Ventilation Parameters in V A/C Ventilation Mode (Continued)

Name	Units	Min. value	Max. value	Adjustment resolution	Default value	Linked parameters
Insp Time	s	0.3	6.0	0.1	1.5	Rate Vt Apnea Time
I Sens	–	0P	5	1	2	–
Sigh <sup>1</sup> Rate		50	250	50	50	–
Sigh Vt	–	1.0	2.0	0.1	1	–

1. When set to YES, Sigh Vt and Sigh Rate are shown. A Sigh Rate of 50 means a sigh is delivered every 50 breaths. Sigh can be set to YES for Rate values of 4 or more.

The alarm parameters adjustable in V A/C mode are shown in [Table 3-8](#).

**Table 3-8.** V A/C Mode Alarm Parameters

Name	Units	Min. value	Max. value	Adjustment resolution	Default value	Linked parameters
Min PIP	cmH <sub>2</sub> O, mbar, or hPa	2	82	1	2	PEEP Max PIP
Max PIP	cmH <sub>2</sub> O, mbar, or hPa	12	90	1	40	PEEP Min PIP
Min VTE	ml	30	1990	10	300	Vt
Max VTE	ml	80	3000	10	1000	Vt
Max Rtot	bpm	10	70	1	OFF	Rate
Min FiO <sub>2</sub>	%	18	90	1	OFF	Max FiO <sub>2</sub>
Max FiO <sub>2</sub>	%	30	100	1	OFF	Min FiO <sub>2</sub>

### 3.5.1 Vt—Tidal Volume

Vt allows you to set the tidal volume to be delivered to the patient at each inspiratory phase. For physiological and safety reasons, the Vt setting is limited by the settings of Insp Time and Rate. The ratio of Vt to Insp Time ( $Vt / Insp\ Time$ ) is  $[3 < (Vt \times 60) / (Insp\ Time \times 1000) < 100]$ .



**WARNING:**

Ensure that the patient circuit is appropriate for the tidal volume setting (tube Ø 22 mm for adults, and Ø 15 mm for pediatric tidal volumes lower than 200 ml).




### 3.5.2 PEEP—Positive End Expiratory Pressure

PEEP allows you to determine the level of pressure maintained during the exhalation phase. The ventilation mode can be adjusted without PEEP (PEEP is nearly 0 mbar when set to OFF).

### 3.5.3 Ramp Pattern—Flow Shape

This parameter is used to adjust the flow distribution shape (or ramp pattern) during the inspiratory phase.

The three flow patterns available are:

-  • Ramp Pattern SQ: Square waveform or constant flow
-  • Ramp Pattern D: Decelerated (sawtooth waveform) or decreasing flow
-  • Ramp Pattern S: Sinusoidal flow

### 3.5.4 Rate—Respiratory Rate

Rate allows you to define the frequency of ventilation cycles triggered by the ventilator.

If the patient actuates the inspiratory trigger, total Rate may increase.

For physiological and efficiency reasons, Rate setting is limited by the settings of Vt and I:E (I/T).

### 3.5.5 Insp Time—Inspiratory Time

This parameter allows the user to set the inspiratory time to 0.3-6.0 s. When changing Insp Time, the ventilator shows the corresponding I:E ratio or I/T% in the settings window. The maximum I:E setting is constrained to 1:1.

### 3.5.6 I Sens—Inspiratory Trigger Sensitivity

I Sens allows you to set the level of inspiratory effort the patient has to provide to initiate a machine breath.

The sensitivity levels are 0P, 1P, 2, 3, 4, and 5 (P denotes pediatric use); the lower the number, the more sensitive the trigger sensitivity.

I Sens can be set to OFF.



#### **WARNING:**

**The inspiration trigger threshold should be carefully modified in order to avoid the risk of false triggering or “autotriggering” of the ventilator. For example, Level 0P, the most sensitive mode, is recommended for pediatric use. However, for an adult, this setting may result in autotriggering.**

### 3.5.7 Sigh Vt

A sigh is an increased volume of gas delivered to the patient at a set rate (that is, every 50 breaths). The Vt multiplied by Sigh Vt gives the amount of volume delivered to the patient during a Sigh.

### 3.5.8 Sigh Rate

Sigh Rate is the frequency with which sigh breaths are delivered.

### 3.5.9 Min and Max PIP—Minimum and Maximum Peak Inspiratory Pressure

A minimum and maximum inspiratory pressure alarm threshold must be set.

The Min PIP (or Low Pressure) setting determines the trigger threshold for the Patient Disconnection alarm. See Chapter 5, *Alarms and Troubleshooting*. If this pressure level is not reached during a fixed time, the alarm is triggered.



**WARNING:**

**The Low PIP alarm setting must be adjusted for the patient, but must also be set high enough to allow the Patient Disconnection alarm to trigger properly. Perform the low pressure test (see *Low Pressure Test* on page F-2) to ensure that the Low PIP alarm is properly set.**

The Max PIP or Max Pressure setting determines the level of pressure which is not to be exceeded during the inspiratory phase. Once this level is reached, inspiration is terminated, ventilation switches to exhalation, and a High PIP alarm is triggered. See Chapter 5, *Alarms and Troubleshooting*.

The difference between the Min PIP and Max PIP settings is limited to a minimum of 8 mbar.

This setting is also limited by the setting of PEEP; thus, the Min PIP setting must exceed the PEEP setting by at least 2 mbar. In addition, the Max PIP setting must exceed the PEEP setting by at least 10 mbar. A change in the PEEP level may lead to automatic changes in the Min PIP, Max PIP, or both thresholds, in order to maintain these setting differences.

### 3.5.10 Min and Max VTE—Minimum and Maximum Exhalation Tidal Volume

Minimum, maximum, or both exhalation tidal volume settings are adjustable, but can only be used with a double-limb circuit configuration.

These thresholds can be set to trigger an alarm if the tidal volume expired by the patient is lower than the minimum threshold set (Low VTE alarm) or greater than the maximum threshold set (High VTE alarm). See Chapter 5, *Alarms and Troubleshooting*.

Min VTE and Max VTE are linked to Vt so that Vt must be greater than Min VTE by at least 10 ml but lower than Max VTE by at least 10 ml.

If Vt is changed, Min VTE and Max VTE are automatically readjusted so that the difference between them is always maintained.

VTE is shown when ventilating with an exhalation valve.

Setting Min VTE and Max VTE is not mandatory (they can be set to OFF, which is the default setting), but the measured value is always shown when using double-limb configurations.



### 3.5.11 Max Rtot—Maximum Total Breath Rate

The maximum rate threshold set monitors the risk of hyperventilation or ventilator autotriggering. Its setting is used to trigger the High Rate alarm. See Chapter 5, *Alarms and Troubleshooting*.

When set, the Max Rtot threshold must always exceed the Rate setting by at least 5 bpm. If the Rate is readjusted, the Max Rtot is automatically readjusted to maintain a minimum difference of 5 bpm.

Setting the Max Rtot is not mandatory (it can be set to OFF, the default setting), but the measured value is always shown.

### 3.5.12 Min and Max FiO<sub>2</sub>—Minimum and Maximum Fraction of Inspired Oxygen

An FiO<sub>2</sub> sensor connected to the patient circuit allows you to determine that the correct level of oxygen is being delivered to the patient.

Min and Max FiO<sub>2</sub> thresholds can be set to trigger Low FiO<sub>2</sub> or High FiO<sub>2</sub> alarms.

FiO<sub>2</sub> Min and FiO<sub>2</sub> Max thresholds are related and their settings must maintain a minimum difference of 10% between the two.

Min and Max FiO<sub>2</sub> settings can be set to OFF if an FiO<sub>2</sub> sensor is not connected. Settings are automatically restored once a sensor is reconnected.

These settings are the same for all ventilation modes.

## 3.6 P SIMV Mode Parameters and Setting Ranges

The menus in the P SIMV (Synchronized Intermittent Mandatory Ventilation Pressure) ventilation mode are shown in [Figure 3-8](#).

Figure 3-8. Menus in P SIMV Ventilation Mode

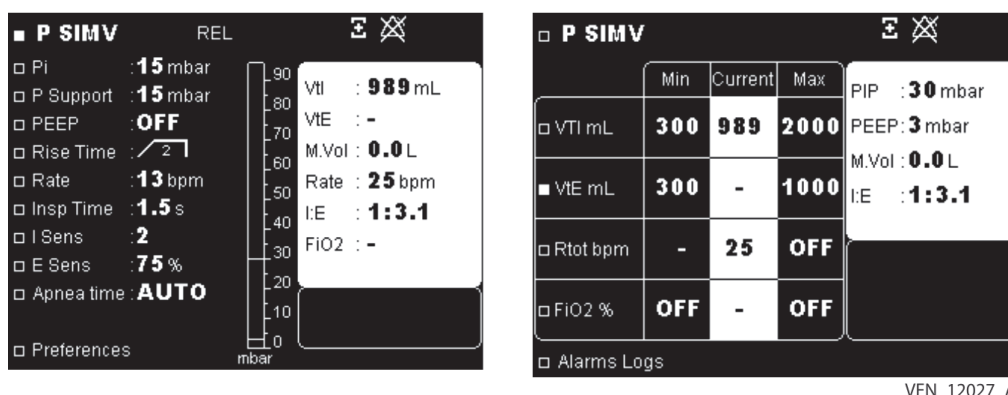


Table 3-9 shows the adjustable Ventilation parameters in P SIMV mode.

**Table 3-9.** Ventilation Parameters in P SIMV Ventilation Mode

Name	Units	Min. value	Max. value	Adjustment resolution	Default value	Linked parameters
Pi	cmH <sub>2</sub> O, mbar, or hPa	5	55	1	15	PEEP
P Support	cmH <sub>2</sub> O, mbar, or hPa	5	55	1	15	PEEP
PEEP	cmH <sub>2</sub> O, mbar, or hPa	OFF	20	1	OFF	P Support Pi
Rate	bpm	1	40	1	13	Max Rtot Insp Time
Insp Time	s	0.3	2.4	0.1	1.5	Rate Vt Apnea Time
E Sens	%	5 (-95)	95 (-5)	5	25	-
I Sens	-	OP	5	1	2	-
Rise Time	-	1	4	1	2	-
Apnea Time	s	1	60	1	Auto	Backup R I:E (I/T)

Table 3-10 shows the adjustable alarm parameters in P SIMV mode.

**Table 3-10.** Alarm Parameters in P SIMV Ventilation Mode

Name	Units	Min. value	Max. value	Adjustment resolution	Default value	Linked parameters
Min VTI	ml	30	2000	10	300	Max VTI
Max VTI	ml	80	3000	10	2000	Min VTI
Min VTE	ml	30	1990	10	300	Max VTE
Max VTE	ml	80	3000	10	1000	Min VTE
Max Rtot	bpm	17	70	1	OFF	Rate
Min FiO <sub>2</sub>	%	18	90	1	OFF	Max FiO <sub>2</sub>
Max FiO <sub>2</sub>	%	30	100	1	OFF	Min FiO <sub>2</sub>

### 3.6.1 Pi—Inspiratory Pressure

When Relative pressure is set to YES in the Setup menu, Pi allows you to determine inspiratory pressure added to PEEP during the inspiratory phase of controlled breaths. In this configuration, the sum of Pi and PEEP must not exceed 55 mbar.

When Relative pressure is set to OFF in the Setup menu, Pi allows you to determine inspiratory absolute pressure of controlled breaths. In this configuration, Pi and PEEP are related and their settings must maintain a minimum difference between the two of 2 mbar in leak configuration and 5 mbar in valve configuration.

### 3.6.2 P Support—Pressure Support

When Relative pressure is set to YES in the Setup menu, P Support allows you to determine inspiratory pressure added to PEEP during the inspiratory phase of spontaneous breaths.

In this configuration, the sum of P Support and PEEP must not exceed 55 mbar.

When Relative pressure is set to OFF in the Setup menu, P Support allows you to determine inspiratory absolute pressure of spontaneous breaths.

In this configuration, P Support and PEEP are related and their settings must maintain a minimum difference between the two of 2 mbar in leak configuration and 5 mbar in valve configuration.

### 3.6.3 PEEP—Positive End Expiratory Pressure

PEEP allows you to determine the level of pressure maintained during the exhalation phase.

When Relative pressure is set to YES in the Setup menu, the sum of  $P_i$  or P Support and PEEP must not exceed 55 mbar.

When Relative pressure is set to OFF,  $P_i$  or P Support and PEEP are related and their settings must maintain a minimum difference between the two of 2 mbar in leak configuration and 5 mbar in valve configuration.

The ventilation mode can be adjusted without PEEP (PEEP is nearly 0 mbar when set to OFF) in valve configuration.

In leak configuration, the minimum PEEP setting is 4 mbar.

### 3.6.4 Rate—Respiratory Rate

R-Rate is the rate at which the ventilator control pressure cycles are initiated, excluding apnea phases.

Rate and Insp Time are related so that if Rate is greater than 12 bpm, then Insp Time must be between 20% and 80% of the breath cycle duration as determined by Rate:

Insp Time  $< 0.33 \times 60 / \text{R Rate}$  if Rate  $\geq 8$ .

Insp Time  $\leq 2.4$  if Rate  $< 8$ .



**Note:**

During apnea ventilation, the ventilator delivers controlled breaths according to a backup rate (Backup R) as long as no inspiratory trigger has been detected.



**Note:**

The Backup R value applied depends on the Rate setting. Hence, Backup R is at least equal to 8 bpm and is equal to the Rate value if Rate is greater than 8 bpm.

### 3.6.5 Insp Time—Inspiratory Time

Insp Time allows you to determine the inspiratory phase duration of ventilator-controlled breaths. For physiological and efficiency reasons, its setting is limited by those of Vt and Rate. The maximum I:E ratio is constrained to 1:2.

Backup R and Insp Time are related.

### 3.6.6 I Sens—Inspiratory Trigger Sensitivity

I Sens allows you to set the level of inspiratory effort the patient has to provide to initiate a machine breath.

The sensitivity levels are 0P, 1P, 2, 3, 4, and 5 (P denotes pediatric use); the lower the number, the more sensitive the trigger sensitivity.

I Sens can be set to OFF.



**WARNING:**

**The inspiration trigger threshold should be carefully modified in order to avoid the risk of false triggering or “autotriggering” of the ventilator. For example, Level 0P, the most sensitive mode, is recommended for pediatric use. However, for an adult, this setting may result in autotriggering.**

### 3.6.7 Apnea Time

Apnea time allows the user to monitor and detect interruptions to the patient's spontaneous breathing pattern. The ventilator declares apnea when no breath has been delivered by the time that the operator-selected apnea interval elapses.

The Apnea time adjustment range shall be 1 to 60 seconds. The ventilator shall enable the operator to set an auto-setting. The Apnea time AUTO setting (in seconds) is calculated using the formula (Auto = maximum value between 3 seconds and 60/Backup R or Auto = 30 if Backup R = OFF).



**Note:**

During apnea ventilation, the ventilator delivers machine controlled breaths according to a backup rate (Backup R)—as long as no inspiratory trigger has been detected.



**Note:**

The Backup R value applied depends on the Rate setting. Hence, Backup R is at least equal to 8 bpm and takes the Rate value if Rate is greater than 8 bpm.

### 3.6.8 Min and Max I Time—Minimum and Maximum Inspiration Time

The minimum (Min I Time) and maximum (Max I Time) duration of the inspiratory phase cannot be set in V SIMV or P SIMV mode. In both the V SIMV and P SIMV modes, the Min I Time defaults to a setting equal to RISE TIME + 300 ms and the Max I Time defaults to the lesser of 3 seconds or 30/Rate.

### 3.6.9 Rise Time

The Rise Time during the inspiratory phase can be set in P SIMV mode and the range is 1-5. The device is configured with a default Rise Time setting of 2 (or a pressure rise time of 200 ms to 800 ms).

### 3.6.10 E Sens—Exhalation Sensitivity

E sens is available in the P SIMV, V SIMV, and PSV modes. In CPAP, E Sens is defaulted to 25% and is not adjustable.

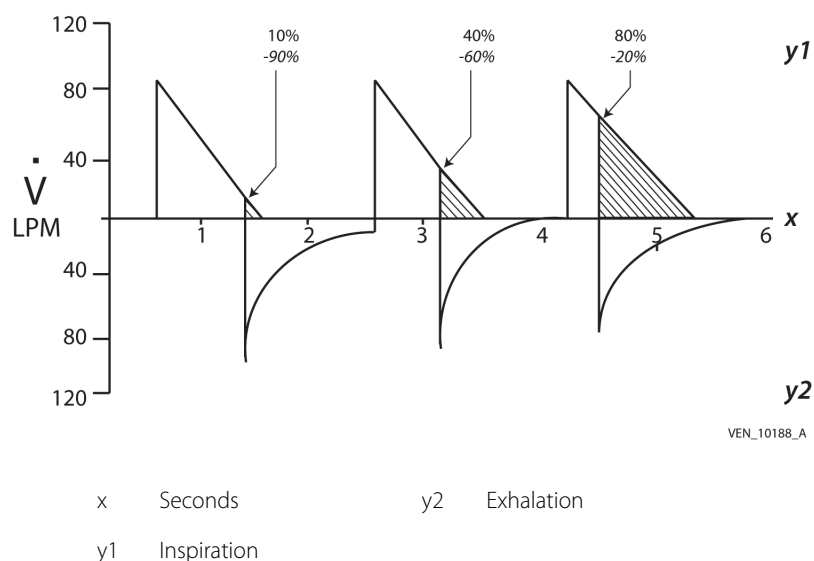
E Sens allows you to determine sensitivity of switching to exhalation and thus indirectly determines the inspiratory time of a breath.

The end of inspiration will occur when Inspiratory Flow has decreased to the preset E Sens setting.

The exhalation trigger is only taken into account after the Rise Time (which constitutes a default minimum inspiratory time) has elapsed.

If the flow drop is insufficient, exhalation is automatically triggered independently of the E Sens, which is defined as a percentage of peak inspiratory flow. Exhalation may be triggered if the maximum inspiratory time has elapsed. For more information about maximum inspiratory time, see section 3.6.8, *Min and Max I Time—Minimum and Maximum Inspiration Time*.

**Figure 3-9.** Exhalation Trigger Sensitivity



**Note:**

See Chapter 7, *Operating Procedures* for positive and negative E Sens settings.

### 3.6.11 Min and Max VTI—Minimum and Maximum Inspiratory Tidal Volume

It is possible to set a Min, Max, or both Tidal Volume alarm threshold for the patient's inspired tidal volume.

This setting is used to trigger an alarm if the tidal volume inspired by the patient is lower than the minimum threshold set (Low VTI alarm) or greater than the maximum threshold set (High VTI alarm). See Chapter 5, *Alarms and Troubleshooting*.

Min VTI and Max VTI are related and their setting must maintain a minimum difference of 20 ml between them.

It is not mandatory to set the minimum and maximum VTI alarm limits. When the minimum and maximum VTI alarm limits are not set, the display will show "OFF" next to these settings.

### 3.6.12 Min and Max VTE—Minimum and Maximum Exhalation Tidal Volume

A Min, Max, or both Tidal Volume Expired by the patient alarm threshold can be set but can only be used in a double-limb circuit configuration.

These thresholds can be set to trigger an alarm if the tidal volume expired by the patient is lower than the minimum threshold set (Low VTE alarm) or greater than the maximum threshold set (High VTE alarm). See Chapter 5, *Alarms and Troubleshooting*.

Min VTE and Max VTE are related and their settings must be set to values that maintain a minimum difference of 20 ml between them.

VTE is shown when ventilating with an exhalation valve.

Setting Min VTE and Max VTE is not mandatory (set to OFF), but the display of the measured value is always active in double-limb configuration.

### 3.6.13 Max Rtot—Maximum Total Breath Rate

The maximum rate threshold set monitors the risk of hyperventilation or ventilator autotriggering. Its setting is used to trigger the High Rate alarm. See Chapter 5, *Alarms and Troubleshooting*.

When set, the Max Rtot threshold must always exceed the Rate setting by at least 5 bpm. If the Rate is readjusted, the Max Rtot is automatically readjusted to maintain a minimum difference of 5 bpm.

Setting the Max Rtot is not mandatory (it can be set to OFF, the default setting), but the measured value is always shown.

### 3.6.14 Min and Max FiO<sub>2</sub>—Minimum and Maximum Fraction of Inspired Oxygen

An FiO<sub>2</sub> sensor connected to the patient circuit allows you to determine that the correct level of oxygen is being delivered to the patient.

Min and Max FiO<sub>2</sub> thresholds can be set to trigger Low FiO<sub>2</sub> or High FiO<sub>2</sub> alarms.

Min and Max FiO<sub>2</sub> thresholds are related and their settings must maintain a minimum difference of 10% between the two.

Min and Max FiO<sub>2</sub> settings can be set to OFF if an FiO<sub>2</sub> sensor is not connected. Settings are automatically restored once a sensor is reconnected.

These settings are the same for all ventilation modes.

### 3.7 V SIMV Mode Parameters and Setting Ranges

The menus in the V SIMV (Synchronized Intermittent Mandatory Ventilation Volume) ventilation mode are shown in [Figure 3-10](#).

Figure 3-10. Menus in V SIMV Ventilation Mode

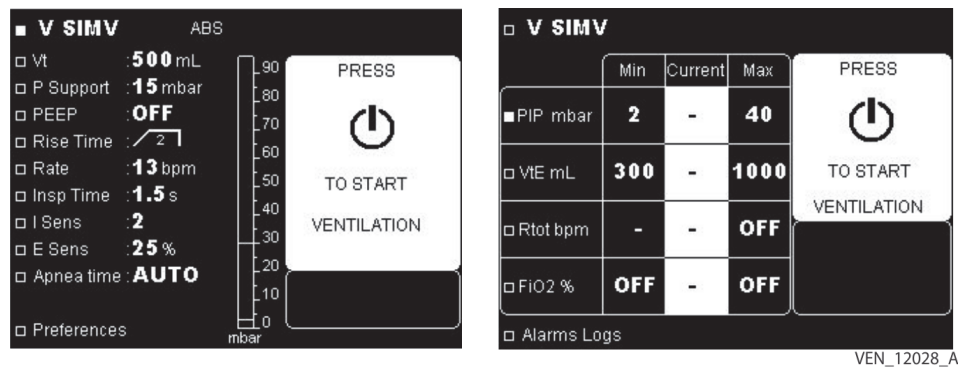


Table 3-11 shows the adjustments and limits in V SIMV mode.

Table 3-11. Ventilation Parameters in V SIMV Mode

Name	Units	Min. value	Max. value	Adjustment resolution	Default value	Linked parameters
Vt	ml	50	2000	10	500	Min VTE Max VTE Insp Time
P Support	cmH <sub>2</sub> O, mbar, or hPa	5	55	1	15	PEEP Min PIP Max PIP
PEEP	cmH <sub>2</sub> O, mbar, or hPa	OFF	20	1	OFF	P Support Max PIP Min PIP
Rate	bpm	1	40	1	13	Vt Max Rtot Insp Time
Insp Time	s	0.3	2.4	0.1	1.5	Vt Rate
E Sens	-	5 (-95)	95 (-5)	5	25	-
I Sens	-	0P	5	1	2	Rate

**Table 3-11.** Ventilation Parameters in V SIMV Mode (Continued)

Name	Units	Min. value	Max. value	Adjustment resolution	Default value	Linked parameters
Rise Time	–	1	4	1	2	–
Apnea Time	s	1	60	1	Auto	Backup R

Alarm parameters that are adjustable in the V SIMV mode menu and their adjustment limits are listed in [Table 3-12](#).

**Table 3-12.** Alarm Parameters in the V SIMV Mode Menu

Name	Units	Min. value	Max. value	Adjustment resolution	Default value	Linked parameters
Min PIP	cmH <sub>2</sub> O, mbar, or hPa	2	52	1	2	Pi PEEP Max PIP
Max PIP	cmH <sub>2</sub> O, mbar, or hPa	12	90	1	40	Pi PEEP Min PIP
Min VTE	ml	30	1990	10	300	Vt Max VTE
Max VTE	ml	80	3000	10	1000	Vt Min VTE
Max Rtot	bpm	17	70	1	OFF	Rate
Min FiO <sub>2</sub>	%	18	90	1	OFF	Max FiO <sub>2</sub>
Max FiO <sub>2</sub>	%	30	100	1	OFF	Min FiO <sub>2</sub>

### 3.7.1 Vt—Tidal Volume

Vt allows you to set the tidal volume delivered to the patient at each inspiration phase of intermittent or successive controlled breath cycles (triggered by the ventilator) in the event of patient apnea.

For physiological and safety reasons, the Vt setting is limited by the settings of Insp Time and Rate.

The ratio of Vt to Insp Time (Vt / Insp Time) must be:

$$3 \text{ lpm} < (Vt \times 60) / (60/\text{Rate} \times I/T) \text{ Insp Time} \times 1000 < 100 \text{ lpm.}$$



**WARNING:**

**Ensure that the patient circuit is appropriate for the tidal volume setting (tube Ø 22 mm for adults, and Ø 15 mm for pediatric tidal volumes lower than 200 ml).**



**Note:**

The Backup R value applied depends on the Rate setting. Hence, Backup R is at least equal to 8 bpm and takes the Rate value if Rate is greater than 8 bpm.



### 3.7.2 P Support—Pressure Support

When Relative pressure is set to YES in the Setup menu, P Support allows you to determine inspiratory pressure added to PEEP during the inspiratory phase of spontaneous breaths.

In this configuration, the sum of P Support and PEEP must not exceed 55 mbar.

When Relative pressure is set to OFF in the Setup menu, P Support allows you to determine inspiratory absolute pressure of spontaneous breaths.

In this configuration, P Support and PEEP are related and their settings must maintain a minimum difference between the two of 2 mbar in leak configuration and 5 mbar in valve configuration.

### 3.7.3 PEEP—Positive End Expiratory Pressure

PEEP allows you to determine the level of pressure maintained during the exhalation phase.

When Relative pressure is set to YES in the Setup menu, the sum of P Support and PEEP must not exceed 55 mbar.

When relative pressure is set to OFF, P Support and PEEP are related and their settings must maintain a minimum difference between the two of 2 mbar in leak configuration and 5 mbar in valve configuration.

The ventilation mode can be adjusted without PEEP (PEEP is nearly 0 mbar when set to OFF) in valve configuration.

In leak configuration, the minimum PEEP setting is 4 mbar.

### 3.7.4 Rate—Respiratory Rate

Rate is the rate at which ventilator-controlled breaths are triggered, excluding apnea ventilation.

Rate and Insp Time are related so that if Rate is greater than 8 bpm, then Insp Time must be:

$$0.2 \times 60 / \text{Rate} < \text{Insp Time} < 0.8 \times 60 / \text{Rate}.$$



**Note:**

During apnea ventilation, the ventilator delivers controlled breaths according to a backup rate (Backup R) as long as no inspiratory trigger has been detected.



**Note:**

The Backup R value depends on the Rate setting. Hence, Backup R is at least equal to 8 bpm and becomes equal to the Rate value if Rate is greater than 8 bpm.

### 3.7.5 Insp Time —Inspiratory Time

Insp Time allows you to determine the inspiratory phase duration of ventilator-controlled breaths. For physiological and efficiency reasons, its setting is limited by those of Vt and Rate. The maximum I:E Ratio is constrained to 1:2.

The ratio Vt/Insp Time must be between 3 liters and 100 liters [ $3 < (Vt \times 60) / (InspTime \times 1000) < 100$ ].



**Note:**

The Backup R value depends on the Rate setting. Hence, Backup R is at least equal to 8 bpm and becomes equal to the Rate value if Rate is greater than 8 bpm.

### 3.7.6 I Sens—Inspiratory Trigger Sensitivity

I Sens allows you to set the level of inspiratory effort the patient has to provide during the initiation of a machine breath.

The sensitivity levels are 0P, 1P, 2, 3, 4, and 5 (P denotes pediatric use); the lower the number, the more sensitive the trigger sensitivity.



**WARNING:**

**The inspiration trigger threshold should be carefully modified in order to avoid the risk of false triggering or “autotriggering” of the ventilator. For example, Level 0P, the most sensitive mode, is recommended for pediatric use. However, for an adult, this setting may result in autotriggering.**

### 3.7.7 Apnea Time

Apnea time allows the user to monitor and detect interruptions to the patient's spontaneous breathing pattern. The ventilator declares apnea when no breath has been delivered by the time that the operator-selected apnea interval elapses.

The Apnea time adjustment range shall be 1 to 60 seconds. The ventilator shall enable the operator to set an auto-setting which shall automatically calculate the Apnea time according to the following: Apnea Time = 60 / BACKUP R for PSV ST mode or 12 s for V SIMV and P SIMV modes.

The Apnea time “AUTO” setting (in seconds) is calculated using the formula (Auto = Maximum value between 3 seconds and 60/Backup R or Auto = 30 if Backup R = OFF).



**Note:**

During apnea ventilation, the ventilator delivers machine controlled breaths according to a backup rate (Backup R)—as long as no inspiratory trigger has been detected.



**Note:**

The Backup R value applied depends on the Rate setting. Hence, Backup R is at least equal to 8 bpm and takes the Rate value if Rate is greater than 8 bpm.

### 3.7.8 Min and Max I Time—Minimum and Maximum Inspiration Time

The minimum (Min I Time) and maximum (Max I Time) duration of the inspiratory phase cannot be set in V SIMV or P SIMV mode. In both the V SIMV and P SIMV modes, the Min I Time defaults to a setting equal to RISE TIME + 300 ms and the Max I Time defaults to the lesser of 3 seconds or 30/Rate.

### 3.7.9 Ramp

**sq** The distribution shape (or flow pattern) of the flow rate during the inspiratory phase cannot be set in V SIMV mode. The device is configured by default with a square wave flow pattern that represents a constant flow rate.

### 3.7.10 Rise Time

The Rise Time during the inspiratory phase can be set in V SIMV mode and the range is 1-5. The ventilator has a default Rise Time of 2 (or a pressure rise time of 400 ms).

### 3.7.11 E Sens—Exhalation Sensitivity

E Sens is available in the P SIMV, V SIMV, and PSV mode. E Sens allows you to determine sensitivity of switching to exhalation and thus indirectly determines the inspiratory time of a breath.

The end of inspiration will occur when inspiratory flow has decreased to the preset E Sens setting.

The exhalation trigger is only taken into account after the Rise Time (which constitutes a default minimum inspiratory time) has elapsed.

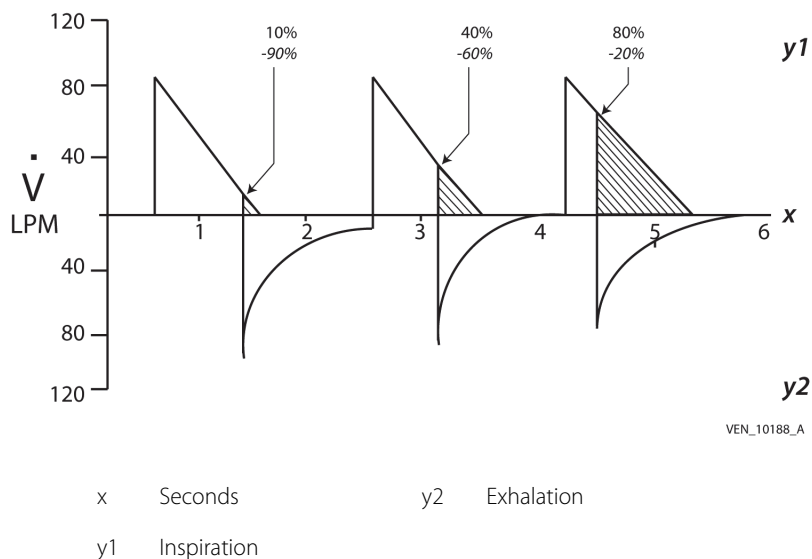
If the flow drop is insufficient, exhalation is automatically triggered independently of the E Sens, which is defined as a percentage of peak inspiratory flow. Exhalation may be triggered if the maximum inspiratory time has elapsed. For more information about maximum inspiratory time, see section [3.7.8, \*Min and Max I Time—Minimum and Maximum Inspiration Time\*](#).



**Note:**

See Chapter 7, *Operating Procedures* for positive and negative E Sens settings.

Figure 3-11. Exhalation Trigger Sensitivity



### 3.7.12 Min and Max PIP—Minimum and Maximum Peak Inspiratory Pressure

A minimum and maximum pressure alarm threshold must be set.

The Min PIP (or Min Pressure) setting determines the trigger threshold for the Patient Disconnection alarm. See Chapter 5, *Alarms and Troubleshooting*.



**WARNING:**

**The setting of the Low PIP alarm must be adjusted for the patient, but must also be set high enough to allow the Patient Disconnection alarm to trigger properly. Perform the low pressure test (refer to *Low Pressure Test* on page F-2) to ensure the Low PIP alarm is properly set.**

The Max PIP or Max Pressure setting determines the level of pressure which is not to be exceeded during the inspiratory phase. When this level is reached, inspiration is terminated, the device switches to exhalation, and a High PIP alarm is triggered. See Chapter 5, *Alarms and Troubleshooting*.

The difference between the Min PIP and Max PIP settings is limited to a minimum of 8 mbar. Their settings are also limited by that of PEEP; thus, Min PIP must be greater than PEEP by at least 2 mbar and Max PIP must be greater than PEEP by at least 10 mbar. A change in the PEEP level may lead to automatic changes in the Min PIP, Max PIP, or both thresholds so that these differences are always maintained.

### 3.7.13 Min and Max VTI—Minimum and Maximum Inspiratory Tidal Volume

It is possible to set a Min and/or Max alarm threshold for the inspired tidal volume received by the patient.

VTI allows you to trigger an alarm during breath delivery if the tidal volume inspired by the patient is lower than the minimum threshold set (Low VTI alarm) or greater than the maximum threshold set (High VTI alarm). See Chapter 5, *Alarms and Troubleshooting*.

Min VTI and Max VTI are related to  $V_t$  such that  $V_t$  must be higher than Min VTI by at least 10 ml, but lower than Max VTI by at least 10 ml.

If  $V_t$  is changed, Min VTI and Max VTI are, if necessary, automatically readjusted so that the difference between them is maintained.

Setting Min VTI and Max VTI is not mandatory (set to OFF), but the display of the measured value is always active in a double-limb configuration.

### 3.7.14 **Min and Max VTE—Minimum and Maximum Exhalation Tidal Volume**

A double-limb patient circuit configuration must be used when setting the Min and/or Max Tidal Volume alarm limits.

These thresholds can be set to trigger an alarm if the tidal volume expired by the patient is lower than the minimum threshold set (Low VTE alarm) or greater than the maximum threshold set (High VTE alarm). See Chapter 5, *Alarms and Troubleshooting*.

Min VTE and Max VTE are linked to  $V_t$  such that  $V_t$  must be greater than Min VTE by at least 10 ml but lower than Max VTE by at least 10 ml.

If  $V_t$  is changed, Min VTE and Max VTE are, if necessary, automatically readjusted so that the difference between them is always maintained.

VTE is shown when ventilating with an exhalation valve.

Setting Min VTE and Max VTE is not mandatory (each can be set to OFF), but the measured value is always shown using a double-limb patient circuit.

### 3.7.15 **Max Rtot—Maximum Total Breath Rate**

The maximum rate threshold set is used to monitor and alarm for ventilator autotriggering.

The alarm setting is used to trigger the High Rate alarm. See Chapter 5, *Alarms and Troubleshooting*.

When set, the Max Rtot threshold must always exceed the backup rate by 5 bpm; the Max Rtot is automatically readjusted to maintain a minimum difference of 5 bpm.

Setting the Max Rtot is not mandatory (it can set to OFF), but the measured value is always displayed.

### 3.7.16 **Min and Max FiO<sub>2</sub>—Minimum and Maximum Fraction of Inspired Oxygen**

An FiO<sub>2</sub> sensor connected to the patient circuit allows you to determine that the correct level of oxygen is being delivered to the patient.

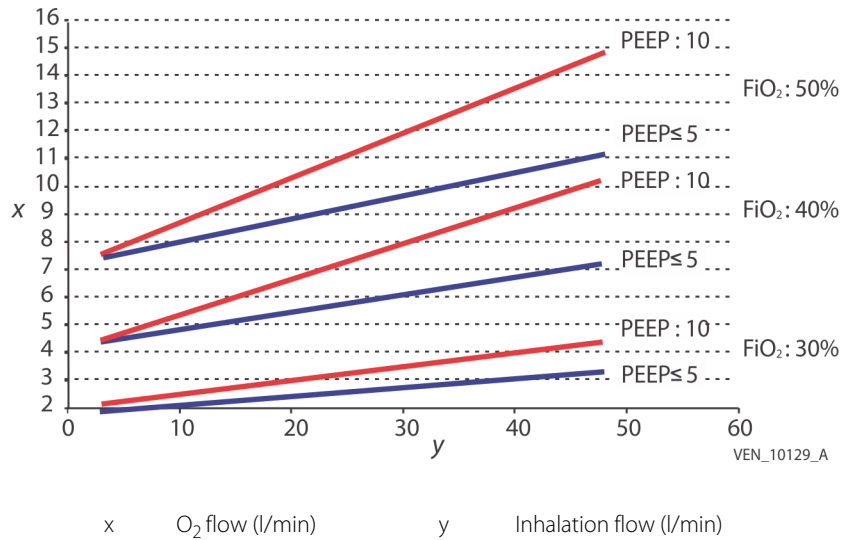
Min and Max FiO<sub>2</sub> thresholds can be set to trigger Low FiO<sub>2</sub> or High FiO<sub>2</sub> alarms.

Min FiO<sub>2</sub> and Max FiO<sub>2</sub> thresholds are related and their settings must maintain a minimum difference of 10% between the two.

Min and Max FiO<sub>2</sub> settings can be set to OFF if an FiO<sub>2</sub> sensor is not connected. Settings are automatically restored once a sensor is reconnected. These settings are the same for all ventilation modes.

### 3.8 FiO<sub>2</sub> For Various Oxygen and Ventilator Settings

**Figure 3-12.** Inhalation Flow (LPM) = Volume (L) x 60 / Inspiratory Time (S).



**Note:**

Tests conducted in a valve configuration. Results can vary according to whether the circuit is configured with or without a valve and patient lung characteristics.



**WARNING:**

The Puritan Bennett™ 560 ventilator can be used with an optional oxygen analyzer with minimum and maximum concentration alarms. Always measure the delivered oxygen with a calibrated oxygen analyzer (FiO<sub>2</sub> kit) that features a minimum and maximum concentration alarm in order to ensure that the prescribed oxygen concentration is delivered to the patient.

# 4 Monitored Parameters

## 4.1 Overview

During ventilation, ventilator parameters measured or calculated are highlighted in the menus used for setting the ventilation parameters, the alarms, and the waveforms.

In addition to showing monitored ventilation parameters, ventilation is shown graphically, as follows:

- Pressure bar chart, in the Ventilation parameters setting menu
- Pressure and flow rate waveforms, according to time, in the Graphic menu (if waveforms was selected in the Preferences menu). See Chapter 7, *Operating Procedures*.



**Note:**

To monitor patient oxygen levels use an external sensor/alarm.

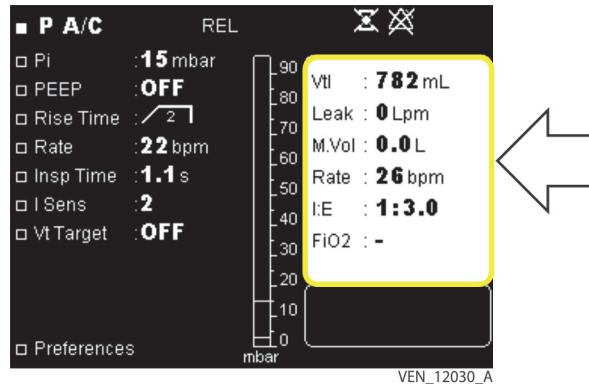
## 4.2 Digital Monitoring

### 4.2.1 Menus

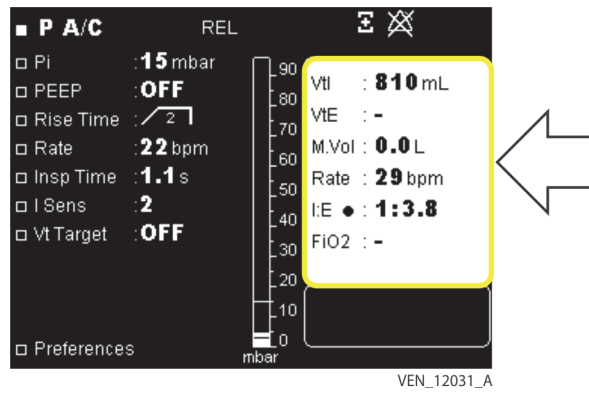
The ventilation parameters monitored or calculated are highlighted in each of the main menus:

- Ventilation menu (Figures 4-1, 4-2, 4-3)
- Alarm menu (Figures 4-4, 4-5, 4-6)
- Waveform menu (Figures 4-7, 4-8, 4-9)

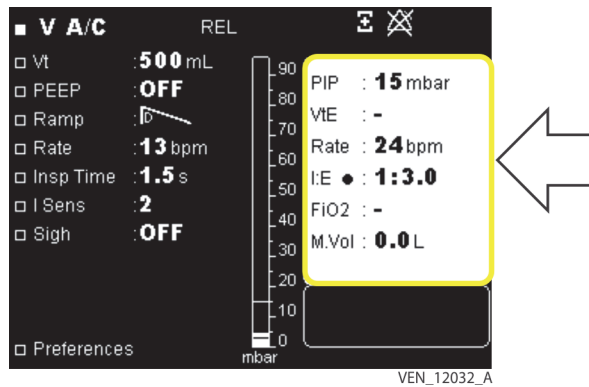
**Figure 4-1.** Ventilation Menu: Pressure Leakage Configuration Modes (CPAP, PSV S, PSV ST, PCV, P A/C)



**Figure 4-2.** Ventilation Menu: Pressure Valve Configuration Modes (PSV S, PSV ST, PCV, P A/C)

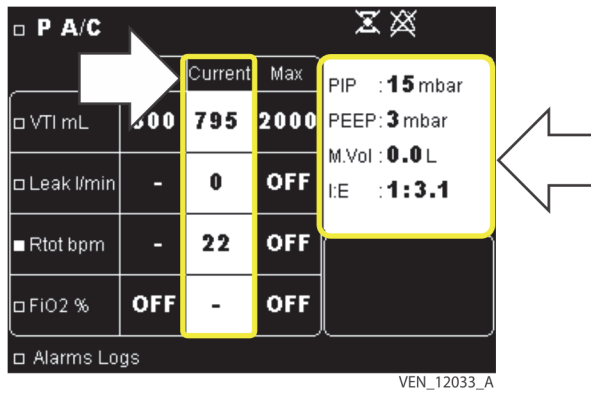


**Figure 4-3.** Ventilation Menu: Volume Mode (CV, V A/C, SIMV)

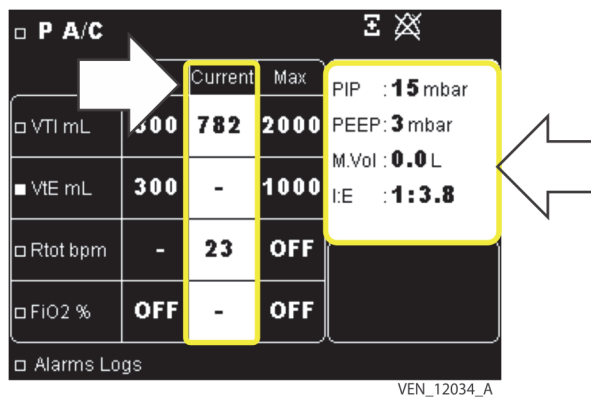




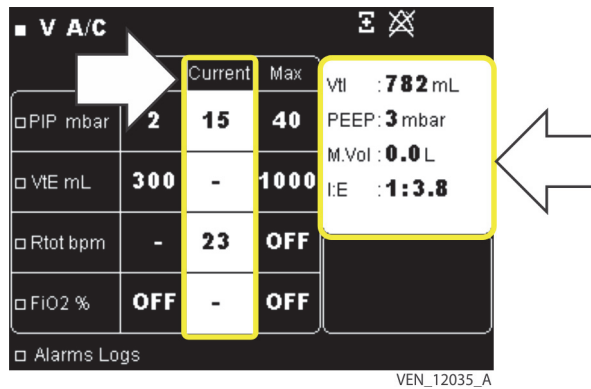
**Figure 4-4.** Alarm Menu: Pressure Leakage Modes (CPAP, PSV S, PSV ST, PCV, P A/C)



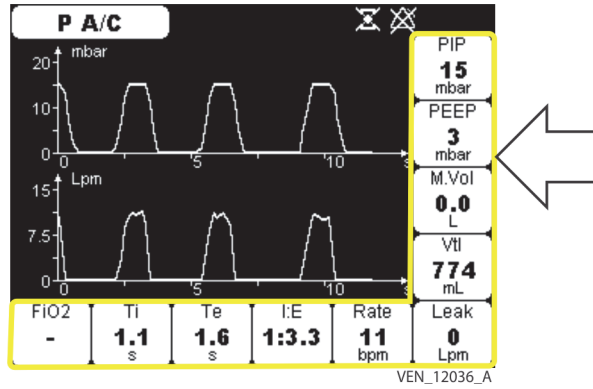
**Figure 4-5.** Alarm Menu: Pressure Valve Modes (PSV S, PSV ST, PCV, P A/C)



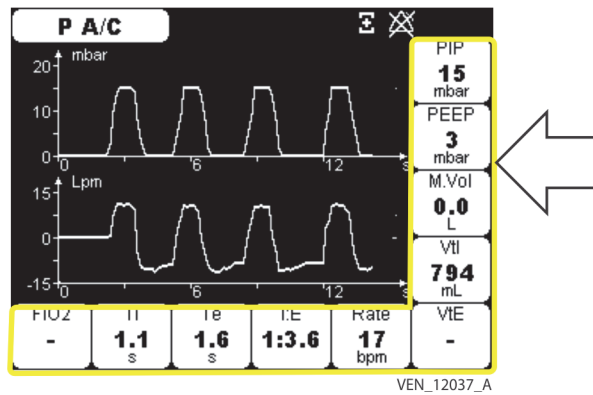
**Figure 4-6.** Alarm Menu: Volume Modes (CV, V A/C, SIMV)



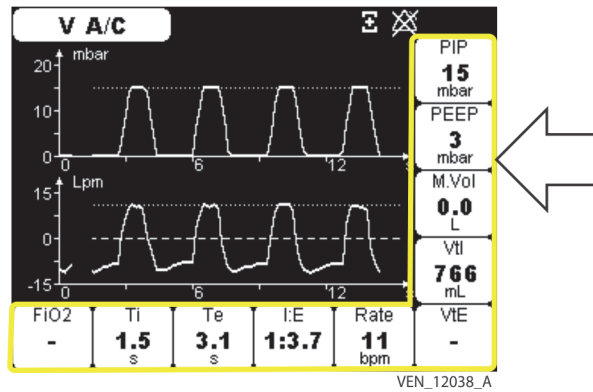
**Figure 4-7.** Waveform Menu: Pressure Leakage Modes (CPAP, PSV S, PSV ST, PCV, P A/C)



**Figure 4-8.** Waveform Menu: Pressure Valve Modes (PSV S, PSV ST, PCV, P A/C)

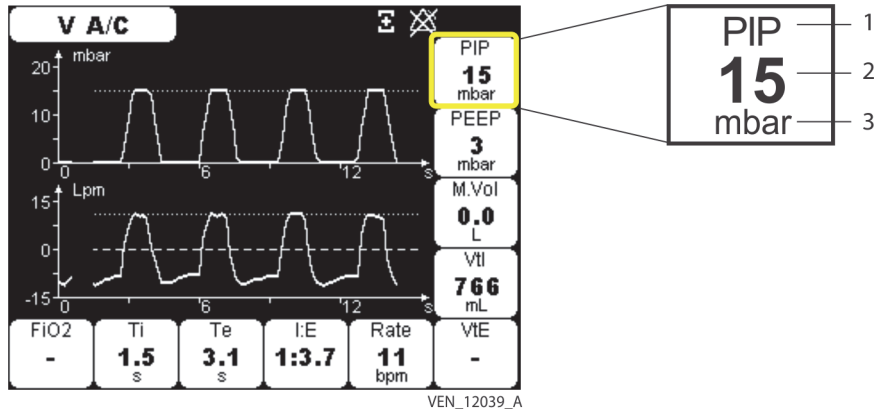


**Figure 4-9.** Waveform Menu: Volume Mode (CV, V A/C, SIMV)



Monitored parameter values are updated every two breath cycles and are shown in the form of inserts, as shown in [Figure 4-10](#).

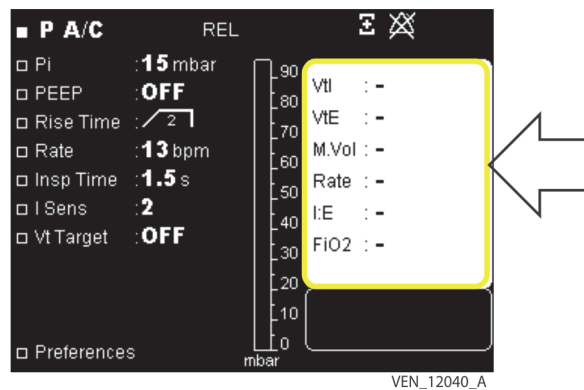
Figure 4-10. Monitored Parameter Inserts



- 1 Parameter name
- 2 Measured or calculated value
- 3 Unit of measure

If the monitored value for a parameter is not applicable or unavailable, the value is replaced by a hyphen “-”, as shown in [Figure 4-11](#).

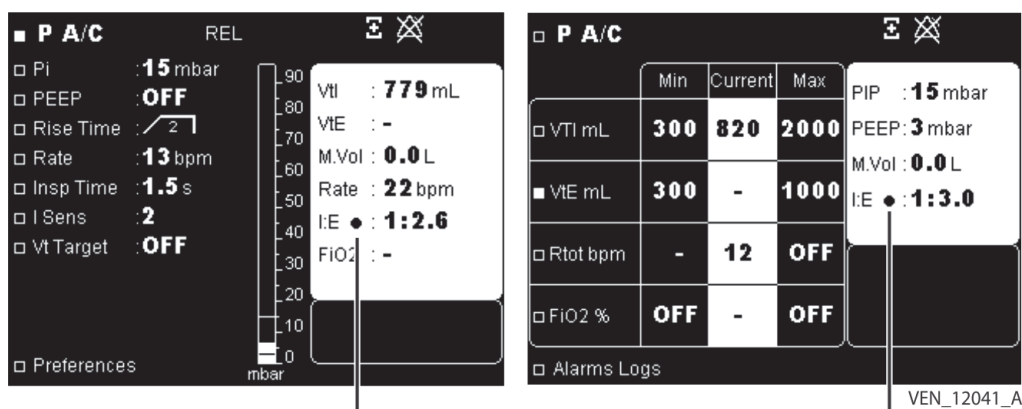
Figure 4-11. Display Showing Unavailable Parameter Values



### 4.2.2 Inspiratory Trigger

- During each inspiration phase triggered by the patient, the Inspiratory effort detected symbol is shown beside the cycling I:E ratio in the Ventilation, Alarm, or Waveform menus. See [Figure 4-12](#).  
The patient triggers the ventilator by inhaling the amount of flow and the ventilator responds by delivering either a pressure-based or volume-based breath.

Figure 4-12. Inspiratory Effort Detected Indicator



### 4.2.3 Monitored Parameters Shown

Table 4-1. Monitored Parameters Shown

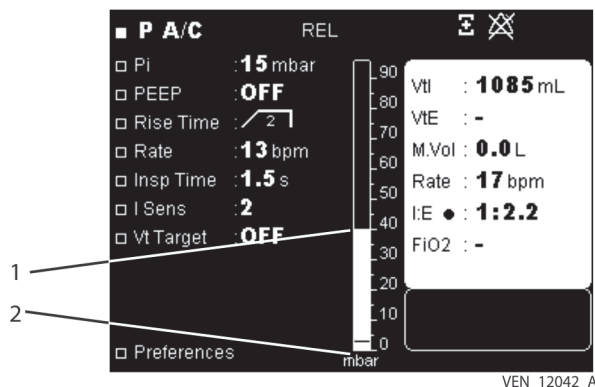
Monitored parameters	Display	Description
Exhaled Tidal Volume	VTE	Patient exhaled flow is measured by the exhalation flow transducer and that measurement is used to calculate volume (the flow transducers do not directly measure volume). The displayed value is updated at each inspiration, but is available only in the double limb patient circuit configuration. Exhaled volume is computed based on a five-breath average.
Exhalation Time	E Time	Exhalation time measured. The displayed value (waveform only) is updated at each inspiration.
Fraction of Inspired Oxygen	FIO <sub>2</sub>	Percentage of oxygen inspired by the patient. The displayed value (waveform only) is updated at each inspiration.
I:E Ratio	I:E	Ratio of inspiratory time measured to exhalation time measured. The displayed value is updated at each inspiration.
Inspiratory Tidal Volume	VTI	Flow delivered by the ventilator to the patient at each inspiratory phase is measured by the inspiratory transducer and that measurement is used to calculate volume (the flow transducers do not directly measure volume). The displayed value is updated at each inspiration. Currently when a Pressure Control or Pressure Support breath is delivered in valve ventilation and a leak is present, the ventilator will increase flow to reach the pressure target. The monitored VTI in Pressure Control or Pressure Support breaths reflects the amount of flow the ventilator delivers from the outlet port during inhalation. The monitored value will increase (possibly to an abnormally high number) when a leak is present. This displayed value is not what is delivered to the patient.
Inspiratory Time	I Time	Inspiratory time measured. The displayed value (only in waveform menu) is updated at each exhalation.
Leak	Leak	Available only in the single-limb patient circuit in leak configuration. The displayed value (only in waveform menu) is updated at each inspiration.

**Table 4-1.** Monitored Parameters Shown (Continued)

Monitored parameters	Display	Description
Minute Volume	M Vol	Flow delivered at each breath to the patient is measured by the inspiratory transducer and that measurement is used to calculate minute volume ( $V_t \times R_{tot}$ ) (the flow transducers do not directly measure volume). The displayed value is updated at each exhalation.
Inspiratory Pressure	Pi	Highest circuit pressure during each inspiration phase measured with the proximal pressure sensor. The displayed value is updated at each exhalation.
Positive End Expiratory Pressure	PEEP	End exhalation pressure is measured by the proximal pressure sensor. The displayed value is updated at each inspiration.
Rate	Rtot	Total number of breaths measured per minute. The displayed value is based on each breath and is updated at each inspiration.
Peak Airway Pressure	Paw	The average peak pressure during the inspiratory phase, measured by each cycle and over the previous 24 hour period.

### 4.3 Bargraph Display

In the ventilation menu, the highlighted bargraph dynamically shows pressures established throughout the breath cycle (Figure 4-13).


**Figure 4-13.** Bargraph Display

- 1 Pi value reached during cycle
- 2 PEEP value

The Pi value reached during a cycle is represented by a line at the top of the bargraph, which remains shown until the maximum value of the following cycle has been reached.

The PEEP value is represented by a line at the bottom of the bargraph.

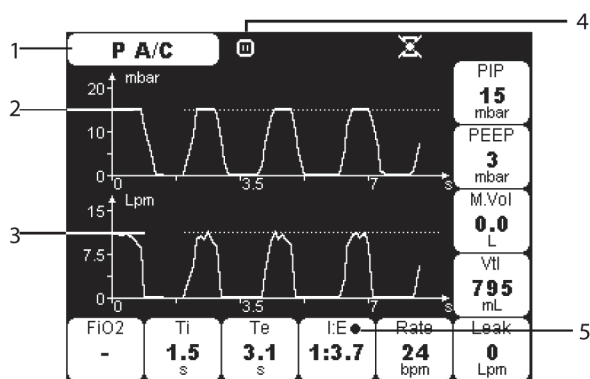
## 4.4 Waveform Display

 The Waveform screen is only accessible during ventilation from the Alarm parameters screen using the MENU key. Its display has been configured in the Preferences menu (see Chapter 7, *Operating Procedures*).

- The pressure waveform and the flow waveform are referenced to time. On these waveforms, the maximum pressure and flow lines are updated each time the graphic window is refreshed (every two breath cycles).
- The scales for pressure and flow automatically adjust according to the maximum levels measured over the last three cycles. The time scale also adjusts automatically according to the breath rate frequency, which allows the display of two consecutive cycles.

The Waveform screen is shown in *Figure 4-14*.

**Figure 4-14.** Waveform Screen



- |   |  |   |                            |
|---|--|---|----------------------------|
| 1 | Ventilation mode                           | 4 | Frozen waveform symbol     |
| 2 | Pressure over last two cycles <sup>1</sup> | 5 | Inspiratory trigger symbol |
| 3 | Maximum flow over last two cycles          |   |                            |

1. Pressure and flow scales are adjusted over three cycles, but only two cycles are displayed

Waveform tracing can be frozen at any time, which enables the analysis of pressure and flow waveforms, while continuing patient ventilation.

 To freeze the waveform trace, press the DOWN key. The following occurs:

- The waveform display is frozen.
- The display of the last numerical monitored values remains fixed.
- The Freeze waveform symbol is shown in the upper part of the screen.



To unfreeze the waveform trace, press the UP key. The following occurs:

- Waveform tracing continues.
- The display of the numerical values monitored is refreshed.



- The Freeze waveform symbol disappears.

The Freeze waveform function remains active even when changing the ventilation or alarm menu, or stopping ventilation. Accessing the Preferences menu or the Alarm Logs screen while the Freeze waveform function is active deactivates this function.



To dismiss the waveform screen manually, press the MENU key.

The waveform screen is automatically dismissed:

- When a high priority alarm is triggered
- When you press the VENTILATION ON/OFF key to stop ventilation

## 4.5 Ventilation Report

The Ventilation Report is available in the Preferences menu (see Chapter 7, *Operating Procedures*). The Ventilation Report updates daily at 8 AM and shows the average readings from the previous 24 hours. See [Figure 4-15](#).

**Figure 4-15.** Ventilation Report

VENTILATION REPORT	
Vent Time	8 h 0 min on 27 APR 2007
VtI	310 mL
VtE	310 mL
Paw	14 mbar
Rate	16 bpm
Leak	-
AI	10 Ew/h
Apnea Ti	30 s
Spont cyc	98 %
Machine :	00012 h
Patient :	00009 h 45 min
■ Back	

VEN\_12044\_A



**Note:**

The values shown in the Ventilation Report are reinitialized when the software is updated or the patient counter is reset to 0.

The following data is shown in the Ventilation Report:

**Vent Time** — The ventilation duration data is based on the patient counter and shows the total ventilation time in hours and minutes over the previous 24-hour period.

**VTI** — When ventilating with an exhalation valve, the VTI is the average inspired tidal volume during each ventilation cycle over the previous 24-hour period. When ventilating in leak mode, the VTI is the average volume delivered by the ventilator during each ventilation cycle over the previous 24-hour period.

**VTE** — When ventilating with a double-limb circuit configuration and an exhalation valve, the VTE is the average exhaled volume during each ventilation cycle over the previous 24-hour period. In a single-limb circuit configuration this value is not measured.

**Paw** — The peak airway pressure is the average peak pressure during the inspiratory phase, measured by each cycle and over the previous 24-hour period.

**Rate** — The respiratory rate is the average of the total respiratory frequency of the patient and the ventilator measured over the previous 24-hour period.

**Leak** — When ventilating with a leak configuration circuit, it is the average parasitic leak during each cycle and over the past 24-hour period. When ventilating with a single-limb circuit there is no average leak.

**AI** — The apnea index is the average number of apnea events per hour of ventilation. It is based on the Apnea alarm.

**Apnea Ti** — Accumulated apnea time over the previous 24-hour period.

**Spont Cyc** — This is the percentage of ventilation cycles initiated by the patient and the ventilator over the previous 24-hour period.

**Machine** — Total time in hours that the ventilator has been switched on since manufacture.

**Patient** — Total time in hours and minutes that the current patient has been ventilated.



# 5 Alarms and Troubleshooting

## 5.1 Overview

The alarms or faults generated by the Puritan Bennett™ 560 ventilator are classified into two categories:

- Ventilation (or utilization) alarms
- Technical faults

Alarms indicate events likely to affect the ventilation in the short term and necessitate rapid intervention (see *Troubleshooting* on page 5-15).

Some of the ventilator alarms are adjustable, depending on ventilation modes (see Chapter 3, *Operating Parameters*). Automatic, nonadjustable alarms also exist to create a safety net for safer patient ventilation.

Technical faults do not directly affect machine operation. Therefore, the user is not alerted to technical faults. Only authorized and trained technicians may consult the Maintenance menu (see the service manual).



**WARNING:**

**Setting any alarm limits to OFF or extreme high or low values can cause the associated alarm not to activate during ventilation, which reduces its efficacy for monitoring the patient and alerting the clinician to situations that may require intervention.**



**WARNING:**

**When an alarm condition is triggered, or there is evidence of a patient-ventilator fault or problem, examine the patient first before examining the ventilator.**



**WARNING:**

**Do not pause, disable, or decrease the volume of the ventilator's audible alarm if patient safety could be compromised.**



**Note:**

Default alarm setting preferences should be entered prior to using the ventilator.

**Note:**

All configurable alarm settings are recorded in the ventilator's nonvolatile internal memory, and are retained when powering down or in the event of a total loss of power.

## 5.2 Alarm Level of Priority

The alarm hierarchy for signaling the level of alarm criticality is listed as follows:

- **Very high priority (VHP): Immediate critical situation; ventilation is impossible:** Continuous sound signaling / with or without continuous red LED illumination / with or without message / with or without display lighting (it is possible for an alarm condition to occur that may not have both a message and lighting)
- **High priority (HP): Critical situation in the short term; ventilation is potentially compromised:** High speed intermittent sound signaling / flashing red LED illumination / with message / with display lighting
- **Medium priority (MP): Critical situation in the long term; ventilation is not affected in the short term:** Medium speed intermittent sound signaling / flashing yellow LED illumination / with message / with display lighting
- **Low priority (LP): Ventilation is not affected in the short term, but potential for delayed minor injury or discomfort:** Medium speed intermittent sound signaling / continuous yellow LED illumination / with message / with display lighting

**Note:**

If there is no corrective action and if the audible alarm is not inhibited (Audio Paused) or reset (Alarm Reset) within 60 seconds, high priority alarms will sound at the maximum level.

## 5.3 Alarm Display

**Note:**

The alarm indicator LEDs to the left of the ALARM CONTROL key on the Puritan Bennett™ 560 ventilator are designed to be visible to the operator at any position where the ventilator is visible to the operator. Specific alarm detail (shown in the alarm message area) is designed to be readable from up to four meters from the screen, at a viewing angle of up to 30°.

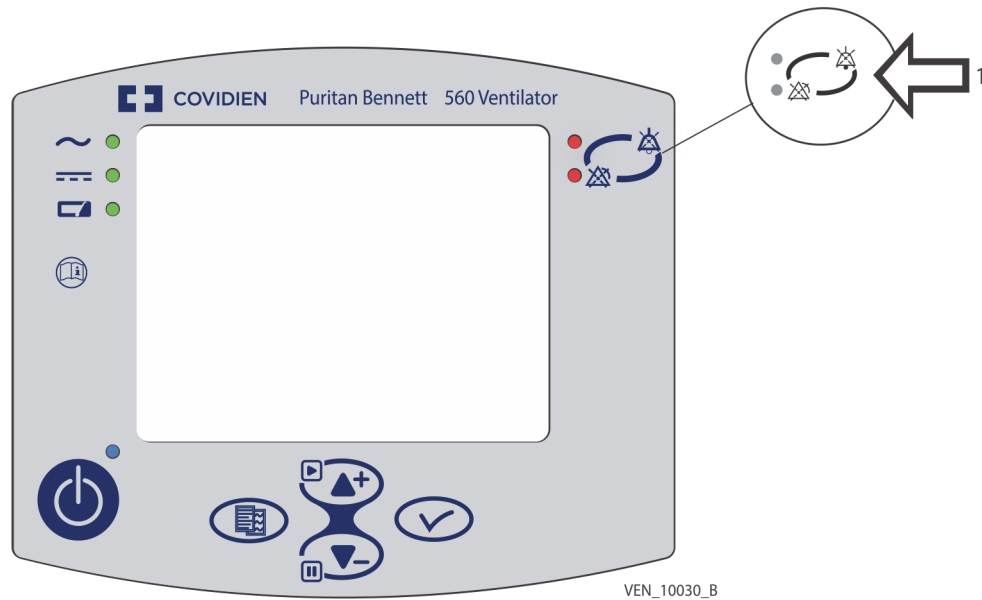
The ventilator is constructed to meet the compliance requirements of the IEC 60601-1-8 alarm standard.

During operation, when an alarm is activated, the following events occur:



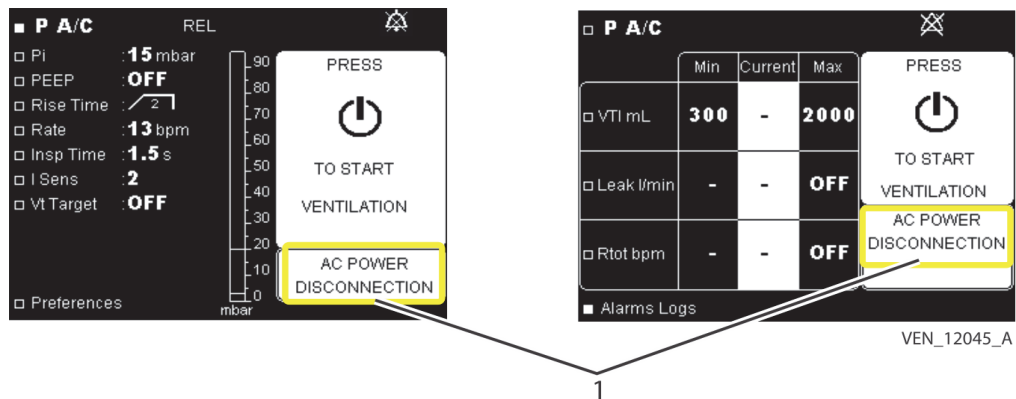
- One of the red or yellow alarm indicators to the left of the ALARM CONTROL key illuminates and possibly flashes.
- An alarm tone sounds.
- A message is shown and flashes in reverse video at the bottom of the Ventilation menu or Alarm menu.

Figure 5-1. Front Panel (Alarm Control Key)



1 Alarm Control key

Figure 5-2. Alarm Messages (in Ventilation menu at left, in Alarm menu at right)



1 Alarm messages

**Note:**

When an alarm is triggered, if the current menu shown is not the Ventilation parameters or Alarm menu, the display automatically switches to one of these menus to show the alarm message.

**Note:**

In the event several alarms are activated at the same time, the highest priority audible and visual alarm is highlighted; however, all active messages are shown, in the sequence in which they occurred.

## 5.4 Alarm Logs Menu

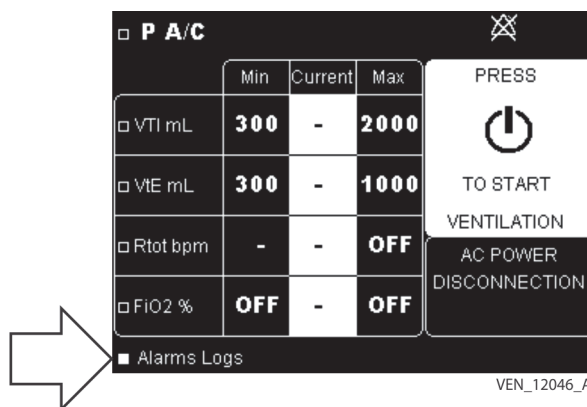
All alarms are recorded in the ventilator’s nonvolatile internal memory at the time of activation, and are retained when powering down or in the event of a total loss of power.

The Alarm Logs menu shows the last eight alarms activated, along with their date and time of activation.

### To access the Alarm Logs menu:

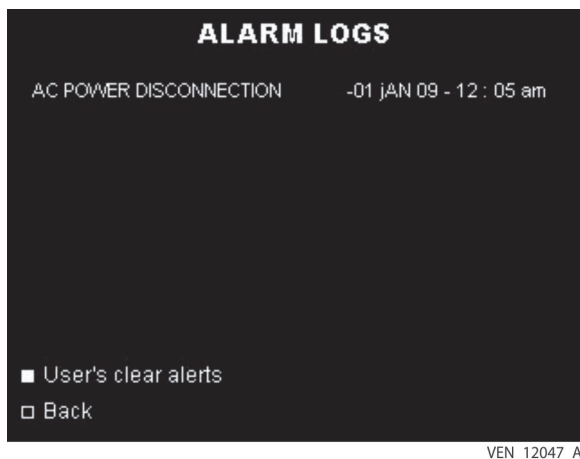
1. Press the MENU key to access the alarm setting menu (if this is not the menu currently shown).
2. Press the DOWN key until the cursor is on the Alarm Logs line at the bottom of the page. The display appears as shown in *Figure 5-3*.

**Figure 5-3.** Accessing the Alarm Logs Menu



3. Press the ENTER key. The Alarm Logs screen is shown.

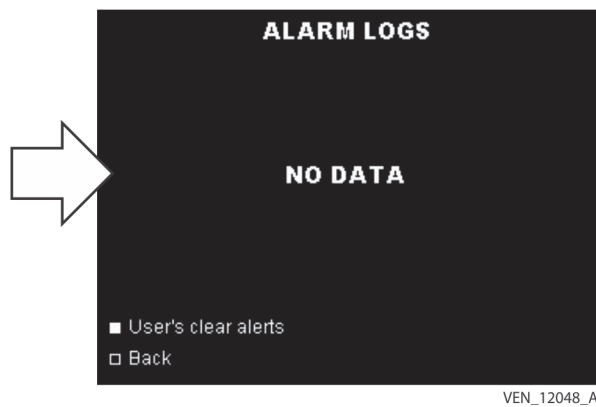
**Figure 5-4.** Alarm Logs Screen



**Note:**

When no alarm has been activated, the message “NO DATA” is shown on the screen (see *Figure 5-5*).

Figure 5-5. Alarm Logs Screen (no alarm activated)



For more information on the User's clear alerts line, see section 5.7, *Reactivating Alarms*.

**To dismiss the Alarm Logs screen manually:**

1. Ensure that the cursor is on the Back line.
2. Press the ENTER key.

The Alarm Logs screen is dismissed automatically:

- After 15 seconds if no keyboard action is detected
- When a high priority alarm is triggered



**Note:**

Only qualified service personnel may access all alarms and events recorded by the ventilator. Qualified personnel should see the service manual for further information.

## 5.5 Pausing the Audible Portion of Alarms



**WARNING:**

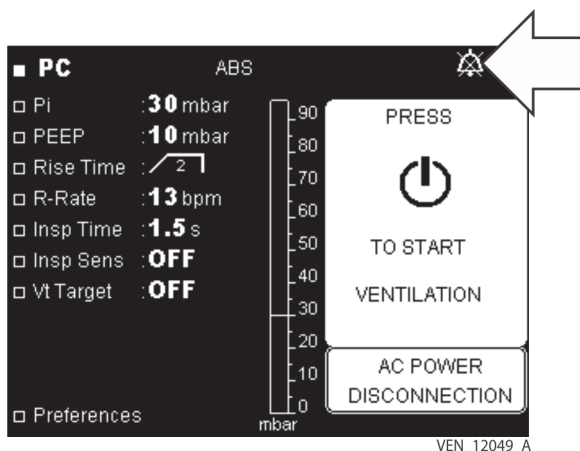
**Do not pause, disable, or decrease the volume of the ventilator's audible alarm if patient safety could be compromised.**




To pause the audible portion of activated alarms for 60 seconds at a time, press the ALARM CONTROL key. This causes the following:

- The audible portion of all activated alarms is paused.
- The visual portions (light indicator and message) of activated alarms remain visible.
- The audio paused symbol is shown at the top right of the screen while the audio pause function is active.

Figure 5-6. Pausing the Audible Portion of Alarms



 If several alarms are activated at the same time, pressing the ALARM CONTROL key affects all current alarms.

The audible portion of activated alarms is automatically reactivated if the following occurs:

- After 60 seconds, if the cause or causes of the alarm or alarms persist
- Whenever a new alarm is activated



**Note:**

If a key is stuck or held down for 45 seconds, a keypad alarm will occur.

## 5.6 Pausing and Resetting Alarms



**WARNING:**

Alarm volume should be adjusted with respect to the ventilator’s operating environment and so that the patient’s caretakers can hear the alarms. The audible alarm vents located at the front of the device should never be obstructed. The alarm can be paused with the Alarm Pause function by pressing the ALARM CONTROL key twice once the alarm has been declared.



**WARNING:**

When an alarm condition is triggered, or there is evidence of a patient-ventilator fault or problem, examine the patient first before examining the ventilator.

Some alarms are not automatically canceled when the condition causing the alarm clears (for example, high pressure). Some alarms can be paused manually even if the cause or causes of their activation remain.



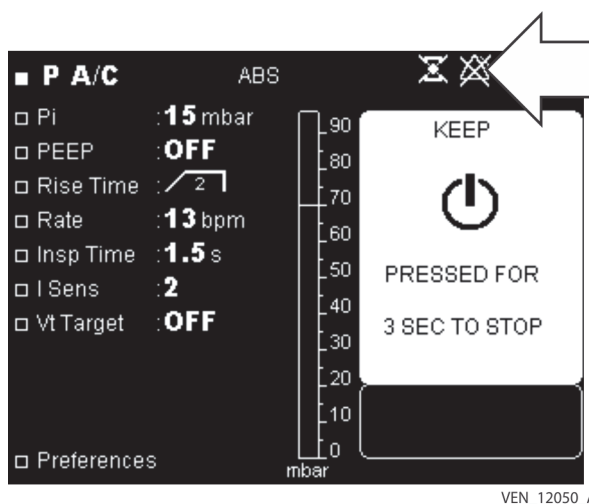
To manually pause an alarm, press the ALARM CONTROL key twice.

- The alarm is paused until the alarm condition is corrected and the condition reoccurs: the audible portion, light indicator, and message are all halted (for alarms that can be paused manually).



- The alarm paused symbol is shown at the top right of the Ventilation, Alarms, and Waveforms screens. See [Figure 5-7](#).

**Figure 5-7.** Ventilator Screen (alarm paused indicator)



When no other alarms are currently activated, the last alarm canceled is shown continuously in the alarm message window in the Alarms menu, along with the date and time of its activation. The High Pressure alarm must be manually reset. See section [5.8, Overview of Alarms](#).



To manually reset the High Pressure alarm, press the ALARM CONTROL key twice. The visual alarms will be reset.

## 5.7 Reactivating Alarms

Alarms that have been paused and whose activation conditions continue to exist can be reactivated.

**To reactivate alarms, proceed as follows:**

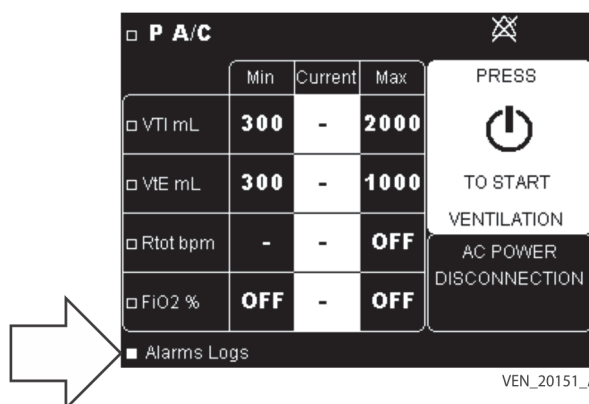


1. Press the MENU key to access the alarm setting menu, if this is not the menu currently shown.



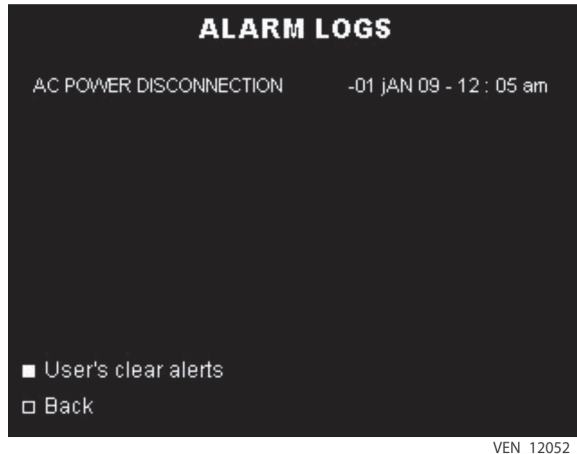
2. Press the DOWN key to position the cursor on the Alarm Logs line, if this is not already the case. See [Figure 5-8](#).

**Figure 5-8.** Reactivating Alarms



3. Press the ENTER key, to confirm access to the Alarm Logs menu.
4. Press the UP key to position the cursor on the User's clear alerts line. See *Figure 5-9*.

**Figure 5-9.** Alarm Logs



VEN\_12052\_A

5. Press the ENTER key for at least 3 seconds. The following events occur:
  - A beep sounds.
  - An audible alarm sounds.
  - An alarm indicator illuminates.
  - The messages of all active alarms are shown in a loop in the Ventilation and Alarm menus.
  - The audio paused symbol disappears (if it was shown).
  - The alarm paused symbol disappears.



## 5.8 Overview of Alarms



### Note:

The message: “\*IF PERSISTS RESTART/SRVC” will occur only if the alarm condition continues for longer than 30 seconds.

**Table 5-1.** Overview of Alarms

Alarm message	Cause/ventilator response	Priority	Audio Paused available	Alarm Paused available
AC POWER DISCONNECTION	Cut-off of the AC (mains) power supply. Alarm activation occurs: <ul style="list-style-type: none"> <li>• Immediately if the Power Fault alarm is OFF</li> <li>• After 5 seconds if the Power Fault alarm is ON and ventilation is stopped</li> <li>• After two breath cycles when ventilation is in progress</li> </ul> Consequence: Switchover to external DC power supply if present; if not, to the internal battery.	If the Power Fault alarm is active: MP Otherwise: LP	Yes	Yes
APNEA	<b>NOTE:</b> The Apnea alarm is equivalent to a hypoventilation alarm. No inspiratory trigger detected by the ventilator after the apnea time set in PSV, CPAP, P SIMV, and V SIMV modes. Automatically clears itself after three successive patient breaths.	MP	Yes	Yes (except for CPAP)
BATTERY FAULT1 RESTART/SRVC	Ventilator has detected an internal battery fault. Consequence: The internal battery is disabled from use.	MP	Yes	Yes
BATTERY FAULT2 RESTART/SRVC	No internal battery detected.	MP	Yes	No
BUZZER FAULT1 RESTART/SRVC	Defective operation of the buzzers.	MP	Yes	No
BUZZER FAULT2 RESTART/SRVC	Failure detected in the very high priority buzzer. Consequence: No audible alarm in case of Power Supply Loss alarm.	MP	Yes	Yes
BUZZER FAULT3 RESTART/SRVC	Battery charge failure due to incorrect voltage. Contact your service representative for assistance.	HP	Yes	No
BUZZER LOW BATTERY	Buzzer battery failure. The battery buzzer voltage is too low. Internal technical problem that prevents the battery sounding the Power Supply Loss alarm.	MP	Yes	Yes
CALIBRATE FiO <sub>2</sub>	An FiO <sub>2</sub> sensor is detected and has not been calibrated.	MP	Yes	Yes


**Table 5-1.** Overview of Alarms (Continued)

Alarm message	Cause/ventilator response	Priority	Audio Paused available	Alarm Paused available
CALIBRATION FAIL	Failure of one calibration point of the internal exhaled flow sensor. Consequence: Failed calibration point is replaced by the default point.	MP	Yes	Yes
CHECK BATTERY CHARGE *IF PERSISTS RESTART/SRVC	Internal battery charging failure. Consequence: Charging of the internal battery impossible.	MP	Yes	No
CHECK EXH VALVE* *IF PERSISTS RESTART/SRVC	Inspired tidal volume during exhalation <20% of Inspired tidal volume and inspired tidal volume >20 mL. Exhalation valve obstructed. Alarm activation occurs after two breath cycles or after 5 seconds, whichever is greater.	HP	Yes	No
CHECK EXH VALVE PRESSURE	Internal ventilation fault related to exhalation valve detection sensor (pressure sensor).	HP	Yes	Yes
CHECK FiO <sub>2</sub> SENSOR	FiO <sub>2</sub> measurement is less than 18%. Recalibrate or change FiO <sub>2</sub> sensor.	HP	Yes	No
CHECK PROXIMAL LINE1* *IF PERSISTS RESTART/SRVC	<b>NOTE:</b> The Check Proximal Line 1 alarm is equivalent to a continuous positive pressure alarm. Loss of signal from the proximal pressure sensor. Consequence: Switch to internal pressure sensor for the pressure measurement. Alarm activation occurs in the event of signal loss, and under the following conditions (time is in seconds): <ul style="list-style-type: none"> <li>• Disconnection time +2 or (60/R-Rate +2), whichever is greater, in P A/C or V A/C mode</li> <li>• Disconnection time +2 or (Apnea time +4), whichever is greater, in CPAP or PSV mode</li> <li>• Disconnection time +2 or (60/R-Rate + Insp time +2), whichever is greater, in P SIMV or V SIMV mode</li> </ul>	MP	Yes	No
CHECK REMOTE ALARM	Failure of ventilator remote alarm relay circuit.	MP	Yes	Yes
CHECK SETTINGS	Alarm activation occurs: <ul style="list-style-type: none"> <li>• Systematically after software versions have changed.</li> <li>• Loss of memorized parameters</li> </ul> Consequence: <ul style="list-style-type: none"> <li>• Locking key disabled</li> <li>• Out-of-range settings are replaced by their default values</li> </ul>	MP	Yes	Yes
CONNECT VALVE OR CHANGE PRESS	<ul style="list-style-type: none"> <li>• No exhalation valve connected with PEEP set to less than 4 mbar</li> <li>• Pi set to more than 30 mbar when relative pressure is set to OFF.</li> </ul>	HP	Yes	No

**Table 5-1.** Overview of Alarms (Continued)

Alarm message	Cause/ventilator response	Priority	Audio Paused available	Alarm Paused available
CONTROLLED CYCLES	The ventilator is delivering apnea ventilation at set back up rate.	N/A	N/A	N/A
COOLING FAN RESTART/SRVC	Ventilator cooling fan operating speed not suited to the internal ambient temperature of the device.	MP	Yes	Yes
DC POWER DISCONNECTION	Cut-off of the external DC power supply. Consequence: Switchover to the internal battery.	LP	Yes	Yes
DEVICE FAULT3 RESTART/SRVC	Failure in the 24 V power supply.	HP	Yes	No
DEVICE FAULT5 RESTART/SRVC	Detection of a fault in the electrical power supply system. Alarm activation occurs once the ventilator is on for at least 3 seconds, and a power supply fault is detected for at least 5 seconds thereafter. Consequence: The internal battery capacity is not shown beside the battery symbol.	MP	Yes	Yes
DEVICE FAULT7 RESTART/SRVC	Detection of a fault in internal voltage measurement.	HP	Yes	No
DEVICE FAULT9 RESTART/SRVC	POST RAM error. RAM read/write does not match memory setting.	VHP	No	No
DEVICE FAULT10 RESTART/SRVC	POST FLASH checksum error. Startup FLASH computed checksum does not match memory setting.	VHP	No	No
DEVICE FAULT11 RESTART/SRVC	POST EEPROM error. Startup EEPROM does not match memory setting.	VHP	No	No
DEVICE FAULT12 RESTART/SRVC	POST reference voltage error. 5V or 10V reference voltage error.	VHP	No	No
DEVICE FAULT13 RESTART/SRVC	Software version error.	VHP	No	No
E SENS FAULT OR CIRC LEAK	At least four of the last six breaths within the last minute are terminated by time.	MP	Yes	No
EMPTY BATTERY	Internal battery capacity <10 minutes or 3%. (battery voltage <22.5 V) Consequence: Ventilation comes to a halt.	If AC power is <b>not</b> connected: HP If AC power is connected: LP	No	No
EXH VALVE LEAKAGE	Abnormally high expired flow during the inspiratory phase of three consecutive breaths (in double-limb setup). Alarm activation occurs after three consecutive breaths.	MP	Yes	No
FiO <sub>2</sub> SENSOR MISSING	No FiO <sub>2</sub> sensor detected and the FiO <sub>2</sub> alarm is active.	HP	Yes	Yes
HIGH / LOW BATTERY TEMP* *IF PERSISTS RESTART/SRVC	Battery temperature out of tolerance. Consequence: Battery charging stops.	MP	Yes	Yes

**Table 5-1.** Overview of Alarms (Continued)

Alarm message	Cause/ventilator response	Priority	Audio Paused available	Alarm Paused available
HIGH FiO <sub>2</sub>	The level of oxygen delivered by the ventilator exceeds the Max FiO <sub>2</sub> level set for 45 seconds.	MP	Yes	No
HIGH INT TEMP COOL VENT* *IF PERSISTS RESTART/SRVC	Device internal ambient temperature out of tolerance range.	MP	Yes	Yes
HIGH LEAKAGE	The leak estimated by the ventilator exceeds the Max leak alarm threshold.	HP	Yes	No
HIGH PRESSURE	Alarm activation occurs after three consecutive breaths, under the following conditions <ul style="list-style-type: none"> <li>• In V A/C or V SIMV modes, if inspiratory pressure is higher than Max PIP during three consecutive cycles.</li> <li>• In PSV, CPAP, P A/C, or P SIMV modes, if inspiratory pressure is higher than (P Support or P Control + PEEP) + 5 mbar up to 29 mbar or + 10 mbar over 30 mbar during three consecutive cycles.</li> <li>• In PSV or CPAP mode and P Support is set to off, if inspiratory pressure is higher than PEEP + 10 mbar during three consecutive cycles.</li> </ul> Consequence: Switch to exhalation phase.	HP <b>NOTE:</b> When alarm condition clears, alarm priority indicator must be manually reset by pressing  . Automatically resets upon activation of lower priority alarm.	Yes	No (The visual portion of the alarm may be paused)
HIGH RATE	Rate measured greater than Max Rtot set during three consecutive breaths.  Alarm activation occurs after three consecutive breaths.	MP	Yes	No
HIGH VTE	Exhaled tidal volume greater than Max VTE set during three consecutive breaths (in double-limb setup).  Alarm activation occurs after three consecutive breaths.	MP	Yes	No
HIGH VTI	Inspired tidal volume greater than Max VTI set during three consecutive breaths in PSV, CPAP, P A/C, P SIMV, and V SIMV modes.  Alarm activation occurs after three consecutive breaths.	HP	Yes	No
INSP FLOW RESTART/SRVC	Inspiratory flow is constant (±1 lpm) with normal turbine temperature and speed conditions. Contact your service representative for assistance.	HP	Yes	No
INTENTIONAL VENT STOP	Ventilation has been stopped voluntarily by the caregiver or patient.	HP	Yes	Yes
KEYPAD FAULT RESTART/SRVC* *IF PERSISTS RESTART/SRVC	Keyboard key held down for more than 45 seconds.	HP	No	No
LOW BATTERY	Internal battery capacity <30 minutes or 8%.	If AC power is <b>not</b> connected: HP If AC power is connected: LP	Yes	No

**Table 5-1.** Overview of Alarms (Continued)

Alarm message	Cause/ventilator response	Priority	Audio Paused available	Alarm Paused available
LOW FiO <sub>2</sub>	The level of oxygen delivered by the ventilator is below the Min FiO <sub>2</sub> level set for 45 seconds.	MP	Yes	No
LOW VTE	Exhaled tidal volume less than Min VTE set during three consecutive breaths (in double-limb setup). Alarm activation occurs after three consecutive breaths.	MP	Yes	No
LOW VTI	Inspired tidal volume less than Min VTI set during three consecutive breaths in PSV, CPAP, P A/C, P SIMV, and V SIMV modes. Alarm activation occurs after three consecutive breaths.	MP	Yes	No
OCCLUSION CHECK CIRCUIT* *IF PERSISTS RESTART/SRVC	Occurs in valve configuration when measured tidal volume is less than 20 ml for PSV, P A/C, and P SIMV modes. Alarm activation occurs after two breath cycles or after 5 seconds, whichever is greater, if the tidal volume is less than 20 mL.	HP	Yes	No
OCCLUSION CHECK CIRCUIT	Occurs in leak configuration when the leak level is not sufficient to flush the CO <sub>2</sub> from patient exhalation. The built-in leak in the mask may be obstructed. The built-in leak for the mask is not sufficient for the settings.	HP	Yes	No
PATIENT DISCONNECTION* *IF PERSISTS RESTART/SRVC	Alarm activation occurs under the following conditions (time is in seconds): <ul style="list-style-type: none"> <li>• Disconnection time or 60/R-Rate, whichever is greater, in P A/C and V A/C mode</li> <li>• Disconnection time or (Apnea time +2 sec), whichever is greater, in CPAP and PSV mode</li> <li>• Disconnection time or (60/R-Rate + Insp time), whichever is greater, in P SIMV and V SIMV mode.</li> </ul> If the flow is greater than 130 lpm during the inspiratory phase. In V A/C and V SIMV modes, if patient pressure is lower than Min PIP. In PSV, CPAP, P A/C modes and P SIMV if patient pressure is lower than (P Support + PEEP) - 20% or (Pi + PEEP) - 20%.	HP	Yes	No
POWER FAULT RESTART/SRVC	Detection of a fault in the electrical power supply system.	MP	Yes	Yes

**Table 5-1.** Overview of Alarms (Continued)

Alarm message	Cause/ventilator response	Priority	Audio Paused available	Alarm Paused available
POWER SUPPLY LOSS (no message)	<ul style="list-style-type: none"> <li>Electrical power supply to the machine is interrupted with the I/O (power) switch when ventilation is in progress.</li> <li>Battery fully discharged when it was the only source of power to the ventilator.</li> </ul> Consequence: Ventilation stops immediately. Ventilation restarts immediately when the switch is pressed or after restoration of the AC or DC supply.	VHP	No—Alarm cancel only	No—Alarm cancel only
PRES SENS FLT1 RESTART/SRVC	Faulty internal pressure sensor signal. Alarm activation occurs after 15 seconds.	HP	Yes	No
PROX SENS FLT2 RESTART/SRVC	Faulty proximal pressure sensor signal. Alarm activation occurs after 15 seconds.	MP	Yes	Yes
REMOVE VALVE CPAP MODE	The ventilation settings are not compatible with the type of patient circuit used. Remove exhalation valve to start CPAP ventilation.	HP	Yes	No
REMOVE VALVE OR CHANGE PRES	The ventilation settings are not compatible with the type of patient circuit used. With a valve circuit, the difference between Pi and PEEP should not be less than 5 mbar.	HP	Yes	No
SOFTWARE VERSION ERROR	Detection of a wrong software version.	N/A	N/A	N/A
TURB OVERHEAT RESTART/SRVC	Turbine speed too low and temperature too high. Consequence: Ventilation stops immediately and O <sub>2</sub> supply stops.	HP	No	No
UNKNOWN BATTERY	The internal battery is not recognized as a Puritan Bennett™ product battery.	MP	Yes	No
VALVE MISSING CONNECT VALVE	Connect exhalation valve to start ventilation in V A/C or V SIMV / P SIMV modes.	HP	Yes	No
VTI NOT REACHED* *IF PERSISTS RESTART/SRVC	Measurement and calculation of tidal volume do not match Vt set during six consecutive breaths in VOL inspired and V SIMV modes. Alarm activation occurs after six consecutive breaths—once the ventilator has reached its performance limits.	HP	Yes	No

## 5.9 Troubleshooting



**WARNING:**

This manual tells you how to respond to ventilator alarms, but it does **NOT** tell you how to respond to the patient.



**WARNING:**

To ensure proper servicing and avoid the possibility of physical injury to personnel or damage to the ventilator, only personnel authorized and qualified by Covidien should attempt to service or make authorized modifications to the Puritan Bennett™ 560 ventilator.

### 5.9.1 Alarms

Table 5-2 offers a guide to the most likely ventilator alarms, possible reasons for the alarms, and corrective actions.



**WARNING:**

Except for replacing the internal battery and performing the recommended maintenance described in Chapters 8 through 10 of this manual, do not try to repair or otherwise service the ventilator yourself, or modify the ventilator, its components, or accessories. Doing so might endanger the patient, cause damage to the ventilator, and/or void your warranty. Only qualified service personnel should attempt repair of the ventilator.



**WARNING:**

When an alarm condition is triggered, or there is evidence of a patient-ventilator fault or problem, examine the patient first before examining the ventilator.



**Note:**

The ventilator screen must be unlocked before settings and parameters can be changed.

**Table 5-2.** Alarms and Corrective Actions

Alarm message or symptom	Possible reason for the alarm event	Corrective action
AC POWER DISCONNECTION	AC (mains) power source cut off.	Cancel the alarm, and then check the supply cable and the effective availability of a voltage on the AC power (“mains”) port.
	Starting with 12–30 VDC external power supply.	Cancel the alarm.
	Current-limiting fuse of the device blown.	Replace the ventilator. Contact your customer service representative for assistance.

**Table 5-2.** Alarms and Corrective Actions (Continued)

Alarm message or symptom	Possible reason for the alarm event	Corrective action
APNEA <b>Note:</b> The Apnea alarm is equivalent to a hypoventilation alarm.	Patient's breathing effort less than the sensitivity control setting.	Ensure the patient is breathing and adjust the inspiratory setting appropriately based on patient's respiratory needs.
	Patient apnea.	Examine the patient for breathing effort and stimulate if necessary.  If patient status has changed adjust the ventilator settings based on patient's respiratory needs.
	Defective sensors.	Contact your customer service representative to arrange for a qualified technician to replace the defective component or components.
BATTERY FAULT1 RESTART/SRVC	Battery problem that prevents operation.	Restart ventilator to see if alarm clears. If not, replace the ventilator. Contact your customer service representative for assistance.
BATTERY FAULT2 RESTART/SRVC	Internal battery missing or not detected.	Restart ventilator to see if alarm clears. If not, replace the ventilator. Contact your customer service representative for assistance.
BUZZER FAULT1 RESTART/SRVC	Defective operation of the buzzers.  Consequence: no audible tone when an alarm is activated.	Restart ventilator to see if alarm clears. If not, replace the ventilator. Contact your customer service representative for assistance.
BUZZER FAULT2 RESTART/SRVC	Internal technical problem that prevents the very high priority Power Supply Loss alarm from triggering.	Ensure that the protective cover over the I/O (power) switch located on the rear of the device is intact and functioning properly. This cover helps prevent accidental pressing of the I/O switch and stoppage of ventilation.  Ensure that the device is stabilized.  Call your customer service representative.
BUZZER FAULT3 RESTART/SRVC	Internal technical problem that prevents the battery from correctly charging.	Restart ventilator to see if alarm clears. If not, replace the ventilator. Contact your customer service representative for assistance.
BUZZER LOW BATTERY	Internal technical problem that prevents the battery warning buzzer from sounding Power Supply Loss alarm.	Connect the ventilator to an AC power source and power on using the I/O (power) switch located on the rear of the ventilator.  Allow the ventilator to charge for a minimum of 15 minutes and up to 2 hours.  If alarm persists, restart ventilator to see if alarm clears. If not, contact your customer service representative for assistance.
CALIBRATE FiO <sub>2</sub>	An FiO <sub>2</sub> sensor is detected and has not been calibrated.	Calibrate FiO <sub>2</sub> sensor.



**Table 5-2.** Alarms and Corrective Actions (Continued)

Alarm message or symptom	Possible reason for the alarm event	Corrective action
CALIBRATION FAIL	Too large a difference between a calibration point and its tolerance range.	Restart calibration. There may be a leak in the circuit. Ensure an approved circuit is in use (see circuit documentation).
	Incorrect circuit type selected in the Preferences menu.	Verify the circuit selection in the Preferences menu matches the circuit in use.
	Exhalation block defective or not properly aligned.	Reset alarm message and ensure all connections are secure, verify circuit integrity, and verify the exhalation block is properly seated.
	Defective exhalation flow sensor.	Contact your customer service representative to arrange for a qualified technician to replace the defective component or components.
CHECK BATTERY CHARGE	Battery charging impossible.	Do not disconnect the ventilator from the AC power supply. Ensure that the power cable is installed according to the instructions in Chapter 6, <i>Installation and Assembly</i> , so that the power cable cannot be involuntarily disconnected. In the event the internal battery capacity is low, use an alternate device to ventilate the patient. Contact your customer service representative for assistance.
CHECK EXH VALVE	Obstruction or abnormal damage of the exhalation valve.	Clean or replace the exhalation valve, its control tube, or both.
	Excessive moisture in the exhalation block.	Remove moisture from exhalation block and valve. Verify exhalation valve is seated properly. Reduce temperature of the humidifier.
	Defective connection or defective exhalation valve tubing.	Reconnect the valve or replace the exhalation valve, the exhalation valve pilot pressure tube, or both.
	Defective inspiratory flow sensor.	Contact your customer service representative to arrange for a qualified technician to replace the defective component or components.
CHECK EXH VALVE PRESSURE	The exhalation valve may not be detected by the ventilator when ventilation is started. The exhalation valve may be falsely detected when ventilation is started.	Restart ventilator to see if alarm clears. If not, replace the ventilator. Contact your customer service representative for assistance.
CHECK FiO <sub>2</sub> SENSOR	FiO <sub>2</sub> measured is less than 18%.	Check that FiO <sub>2</sub> sensor is properly connected. Recalibrate FiO <sub>2</sub> sensor. Replace FiO <sub>2</sub> sensor.
CHECK PROXIMAL LINE1*  *IF PERSISTS RESTART/SRVC  <b>Note:</b> The Check Proximal Line 1 alarm is equivalent to a continuous positive pressure alarm.	No connection of the proximal pressure tube when ventilation starts.	Reconnect the proximal pressure line.
	Proximal pressure line disconnected or obstructed.	Reconnect the connection line or replace it if obstructed. Check for moisture or occlusion of the proximal line. Reduce humidifier temperature. Switch to a heated wire circuit.
	Defective proximal pressure sensor or internal leak of the machine.	Restart ventilator to see if alarm clears. If not, contact your customer service representative to arrange for a qualified technician to replace the defective component or components.

**Table 5-2.** Alarms and Corrective Actions (Continued)

Alarm message or symptom	Possible reason for the alarm event	Corrective action
CHECK REMOTE ALARM	Nurse call or remote alarm system is disconnected.	Connect the nurse call or remote alarm cable to the ventilator.
	Relay control voltage problem.	Carefully monitor the patient to detect possible alarm triggering and call for the maintenance technician.
CHECK SETTINGS	Loss of memorized parameters.	Check and adjust the prescribed parameters, if necessary.
	Software versions have changed.	Check and adjust the prescribed parameters, if necessary.
CONNECT VALVE OR CHANGE PRESS	The ventilation settings are not compatible with the type of patient circuit used. No exhalation valve connected with PEEP set to less than 4 mbar. Pi set to more than 30 mbar when relative pressure is set to OFF.	Connect exhalation valve. Decrease Pi to less than 30 mbar in absolute pressure. Increase PEEP to more than 3 mbar. <b>NOTE:</b> Always consult the clinician before changing PEEP, FiO <sub>2</sub> , pressure, volume, or Rate settings.
CONTROLLED CYCLES	The ventilator is delivering apnea ventilation at set back up rate.	Check that the patient circuit is correctly attached and the patient is correctly ventilated.
COOLING FAN RESTART/SRVC	Operating speed of the cooling fan not properly adjusted for the internal ambient temperature of the device.	Restart ventilator to see if alarm clears. If not, replace the ventilator. Contact your customer service representative for assistance.
DC POWER DISCONNECTION	12–30 VDC power supply cut off when there is no AC (mains) power supply.	Cancel the alarm, and then check the supply wiring and the effective availability of voltage on the external source.
	Ventilator's current-limiting fuse blown.	Replace the ventilator. Contact your customer service representative for assistance.
DEVICE FAULT3 IF PERSISTS RESTART/ SRVC	24V supply failure.	Restart ventilator to see if alarm clears. If not, replace the ventilator. Contact your customer service representative for assistance.
DEVICE FAULT5 IF PERSISTS RESTART/ SRVC	Internal problem in the electrical power supply.	Restart ventilator to see if alarm clears. If not, replace the ventilator. Contact your customer service representative for assistance.
DEVICE FAULT7 IF PERSISTS RESTART/ SRVC	Internal technical problem.	Restart ventilator to see if alarm clears. If not, replace the ventilator. Contact your customer service representative for assistance.
DEVICE FAULT9 IF PERSISTS RESTART/ SRVC	POST RAM error. RAM read/write does not match memory setting.	If patient has been disconnected, reconnect patient to reset the fault. If the error persists, restart ventilator to see if alarm clears. If not, replace the ventilator. Contact your customer service representative for assistance.
DEVICE FAULT10 IF PERSISTS RESTART/ SRVC	POST FLASH checksum error. Startup FLASH computed checksum does not match memory setting.	Restart ventilator to see if alarm clears. If not, replace the ventilator. Contact your customer service representative for assistance.
DEVICE FAULT11 IF PERSISTS RESTART/ SRVC	POST EEPROM error. Startup EEPROM does not match memory setting.	Restart ventilator to see if alarm clears. If not, replace the ventilator. Contact your customer service representative for assistance.
DEVICE FAULT12 IF PERSISTS RESTART/ SRVC	POST reference voltage error. 5 V or 10 V reference voltage error.	Restart ventilator to see if alarm clears. If not, replace the ventilator. Contact your customer service representative for assistance.

**Table 5-2.** Alarms and Corrective Actions (Continued)

Alarm message or symptom	Possible reason for the alarm event	Corrective action
DEVICE FAULT13 IF PERSISTS RESTART/ SRVC	Incorrect software version detected.	Restart ventilator to see if alarm clears. If not, replace the ventilator. Contact your customer service representative for assistance.
EMPTY BATTERY	Internal battery capacity is less than 10 minutes (or 3%)—battery operation overextended.	Reconnect the device to an AC power outlet, connect it to an external DC power source, or replace the battery. <b>NOTE:</b> The internal battery can be charged only when the ventilator is connected to an AC power supply.
E SENS FAULT OR CIRC LEAK	Leak in the patient circuit, leak in patient artificial airway or vented mask interface.	Check and properly connect the patient circuit connections. Minimize the leak. Ensure O <sub>2</sub> connector is removed. Reduce inspiratory time. Increase E-Sensitivity setting. Check tracheotomy cuff. Refit mask. Use non-vented mask. <b>NOTE:</b> Always consult the clinician before changing PEEP, FiO <sub>2</sub> , pressure, volume or Rate settings.
	E sensitivity setting not properly adjusted.	Check E Sensitivity setting <b>NOTE:</b> Always consult the clinician before changing PEEP, FiO <sub>2</sub> , pressure, volume or Rate settings.
EXH VALVE LEAKAGE	Large leakage detected on the patient circuit return limb during the inspiratory phase.	Replace the exhalation valve, its control tube, or both.
	Contaminated or defective exhalation flow sensor.	Restart ventilator to see if alarm clears. If not, contact your customer service representative to arrange for a qualified technician replace the defective component or components.
FI <sub>O</sub> <sub>2</sub> SENSOR MISSING	There is no FiO <sub>2</sub> sensor, and FiO <sub>2</sub> alarms are active.	If oxygen is to be delivered to the patient, connect FiO <sub>2</sub> sensor. If no oxygen is to be delivered to the patient, deactivate FiO <sub>2</sub> alarms.
HIGH FI <sub>O</sub> <sub>2</sub>	The level of oxygen being delivered to the patient is higher than the Max FiO <sub>2</sub> limit set.	Check the level of oxygen corresponds to the patient's prescription. Increase the FiO <sub>2</sub> alarm threshold. <b>NOTE:</b> Always consult the clinician before changing PEEP, FiO <sub>2</sub> , pressure, volume or Rate settings.

**Table 5-2.** Alarms and Corrective Actions (Continued)

Alarm message or symptom	Possible reason for the alarm event	Corrective action
HIGH INT TEMP COOL VENT	Internal ambient temperature of the device out of the tolerance ranges.	If the ambient temperature is too low, place the device in a warmer environment. If the ambient temperature is too high, place the ventilator in a cooler environment. For example, ensure the ventilator is not in direct sunlight or next to an air conditioning vent. <b>WARNING: In case of operation in a high ambient temperature, handle the ventilator with care; some portions of the device may have high surface temperatures.</b> <b>WARNING: In the case of high ambient temperatures, it may take a significant period of time to cool the internal temperature of the ventilator to the proper operating range. To avoid injury to the patient, ensure that the air inspired by the patient does not exceed 41°C (106°F). If in doubt, replace the ventilator.</b> <b>NOTE:</b> The temperature fault alarm does not interfere with the operation of the ventilator. <b>NOTE:</b> Ensure that you are operating the ventilator within the proper temperature range (refer to Appendix B, <i>Specifications</i> ).
	Defective internal temperature probe or any other technical anomaly.	Replace the ventilator. Contact your customer service representative for assistance.
HIGH/LOW BATTERY TEMP* *IF PERSISTS RESTART/SRVC	Battery temperature out of the tolerance ranges. Defective internal temperature probe or any other technical anomaly inside the battery.	If the ambient temperature is too low, place the device in a warmer environment. If the ambient temperature is too high, place the ventilator in a cooler environment. For example, ensure the ventilator is not in direct sunlight or next to an air conditioning vent. Restart ventilator to see if alarm clears. If the alarm message persists, please contact technical services. <b>WARNING: In case of operation in a high ambient temperature, handle the ventilator with care; some portions of the device may have high surface temperatures.</b> <b>CAUTION: Do not attempt to charge a defective battery; such a battery cannot be charged.</b> <b>NOTE:</b> The temperature fault alarm does not interfere with the operation of the ventilator. <b>NOTE:</b> Ensure that the ventilator is being used according to the operating instructions found in Appendix B, <i>Specifications</i> .
HIGH LEAKAGE	The leak estimated by the ventilator exceeds the Max Leak alarm threshold.	Readjust mask to reduce leakage. Increase the alarm settings.

**Table 5-2.** Alarms and Corrective Actions (Continued)

Alarm message or symptom	Possible reason for the alarm event	Corrective action
HIGH PRESSURE	Adjustment of Max PIP too low (only for V A/C and V SIMV modes).	Increase the Max PIP threshold. <b>NOTE:</b> Always consult the clinician before changing PEEP, FiO <sub>2</sub> , pressure, volume or Rate settings.
	Airway obstruction.	Check patient's trachea and clear the obstruction. If the filter is obstructed, replace the filter.
	Proximal pressure tube or patient circuit obstructed.	Clean the proximal pressure tube or the patient circuit or replace them.
	Coughing or other high-flow exhalation efforts.	Treat patient's cough. Pause the audible alarm, if necessary.
	Patient inspiratory resistance or compliance changes.	Have physician determine if ventilator settings are appropriate for the patient.
	Defective internal circuits of the machine or pressure sensor.	Replace the ventilator. Contact your customer service representative for assistance.
HIGH RATE	Adjustment of the Max Rtot level too low.	Readjust Max Rtot.
	Adjustment of the I Sens level too low.	Adjust I Sens according to the patient.
	Patient hyperventilating.	Pause the audible alarm, and call for a medical team if the symptoms persist. Check for auto-cycling and adjust inspiratory sensitivity. Manage leaks. Drain condensation from patient circuit.
	Defective inspiratory flow sensor.	Contact your customer service representative to arrange for a qualified technician to replace the defective component or components.
HIGH VTE	Adjustment of the Max VTE level too low.	Modify the Max VTE level. <b>NOTE:</b> Always consult the clinician before changing PEEP, FiO <sub>2</sub> , pressure, volume or Rate settings.
	Inappropriate patient circuit.	Replace the patient circuit. Ensure there is not excessive airflow near the exhalation block (such as a fan).
	Exhalation flow sensor not calibrated properly.	Calibrate the exhalation flow sensor (see <i>Calibrating the Exhalation Flow Sensor</i> on page 10-2).
	Defective exhalation flow sensor.	Replace the exhalation block and calibrate the exhalation flow sensor (see <i>Calibrating the Exhalation Flow Sensor</i> on page 10-2). Call your customer service representative.

**Table 5-2.** Alarms and Corrective Actions (Continued)

Alarm message or symptom	Possible reason for the alarm event	Corrective action
HIGH VTI	Adjustment of the Max VTI level too low (for PSV, CPAP, P A/C, P SIMV, and V SIMV modes).	Modify the Max VTI level. <b>NOTE:</b> Always consult the clinician before changing PEEP, FiO <sub>2</sub> , pressure, volume or Rate settings.
	Adjustment of the pressure level too high for the volume required (for PSV, CPAP, P A/C, P SIMV, and V SIMV modes).	Modify the pressure level. <b>NOTE:</b> Always consult the clinician before changing PEEP, FiO <sub>2</sub> , pressure, volume or Rate settings.
	A leak in the patient circuit causing increased bias flow.	Check and properly connect the patient circuit.
	Inappropriate patient circuit.	Replace with an appropriate circuit.
	Defective flow sensor or internal leak in the machine.	Contact your customer service representative to arrange for a qualified technician to replace the defective component or components and call your customer service representative.
INSP FLOW RESTART/SRVC	Inspiratory flow is constant ( $\pm 1$ lpm) with normal turbine temperature and speed conditions.	Restart ventilator to see if alarm clears. If not, replace the ventilator. Contact your customer service representative for assistance.
INTENTIONAL VENT STOP	The user/caregiver has stopped ventilation using the VENTILATION ON/OFF button. Ventilation is in stand-by.	Check that the ventilation was switched off on purpose. This alarm can be deactivated. See section 7.2.2, <i>Changing the Setup Menu Parameters</i> .
KEYPAD FAULT RESTART/SRVC	Pressing a key for more than 45 seconds.	Press and release keys in the normal, prescribed manner. Do not press keys for 45 seconds or more.
	A key on the keyboard is stuck.	If unsuccessful in releasing the stuck key or keys, restart ventilator to see if alarm clears. If not, replace the ventilator. Contact your customer service representative for assistance.
LOW BATTERY	Internal battery capacity is less than 30 minutes (or 8%)—battery operation overextended.	Immediately connect the ventilator to an AC power outlet or to an external DC power source. <b>NOTE:</b> The internal battery can be charged only when the ventilator is connected to an AC power supply.
LOW FiO <sub>2</sub>	The level of oxygen being delivered to the patient is below the Min FiO <sub>2</sub> limit set.	Check the level of oxygen corresponds to the patient’s prescription. Decrease the FiO <sub>2</sub> alarm threshold. <b>NOTE:</b> Always consult the clinician before changing PEEP, FiO <sub>2</sub> , pressure, volume or Rate settings.

**Table 5-2.** Alarms and Corrective Actions (Continued)

Alarm message or symptom	Possible reason for the alarm event	Corrective action
LOW VTE	Patient circuit obstructed.	Clean, unblock, or properly connect the patient circuit.
	Leak in the patient circuit.	Check and properly connect the patient circuit connections. May be caused by increased resistance across exhalation filter (such as excessive moisture).
	Exhalation block missing or disconnected.	Restore or connect the exhalation block (see <i>Exhalation Block</i> on page 6-20). If the exhalation block has been removed or replaced, calibrate the exhalation flow sensor (see <i>Calibrating the Exhalation Flow Sensor</i> on page 10-2). If no exhalation block is present, contact your customer service representative.
	Adjustment of a Min VTE threshold when the patient circuit is in a single-limb configuration.	Set the Min VTE alarm limit to OFF. <b>WARNING: If exhaled tidal volume monitoring is required, use the double-limb circuit.</b>
	Inappropriate patient circuit.	Replace with an appropriate circuit.
	Exhalation flow sensor not properly calibrated.	Calibrate the exhalation flow sensor (see <i>Calibrating the Exhalation Flow Sensor</i> on page 10-2).
	Defective exhalation flow sensor.	Replace the defective component or components and calibrate the exhalation flow sensor (see <i>Calibrating the Exhalation Flow Sensor</i> on page 10-2). Call your customer service representative.
	Adjustment of the Min VTE level too high.	Modify the Min VTE level.
LOW VTI	Adjustment of the Min VTI level too high (for PSV, CPAP, P A/C, P SIMV, and V SIMV modes)	Modify the Min VTI level.
	Adjustment of the pressure level not enough to reach the volume required (for PSV, CPAP, P A/C, P SIMV, and V SIMV modes).	Modify the pressure level according to the physician's prescription.
	Patient circuit obstructed or disconnected.	Clean, unblock, or reconnect the patient circuit.
	Inappropriate patient circuit.	Replace with an appropriate circuit.
	Defective flow sensor or internal leak in the machine.	Check patient and replace the ventilator. Contact your technician or customer service representative for assistance.
OCCLUSION CHECK CIRCUIT *IF PERSISTS RESTART/SRVC	Patient circuit obstructed.	Clean, unblock, or properly connect the patient circuit.
OCCLUSION CHECK CIRCUIT	A non-vented configuration is being used or the built-in leak in the mask or in the circuit may be obstructed or insufficient for the settings. Note that a high patient or backup respiratory rate may not sufficiently flush out CO <sub>2</sub> in some vented pediatric masks.	Replace the nonvented circuit with a vented one. Clean, unblock the mask or the circuit of the vented system, or switch to a vented system with a larger leak configuration. Try to reduce patient's backup rate if possible.

**Table 5-2.** Alarms and Corrective Actions (Continued)

Alarm message or symptom	Possible reason for the alarm event	Corrective action
PATIENT DISCONNECTION *IF PERSISTS RESTART/SRVC	Adjustment of Min PIP too high.	Decrease the Min PIP threshold.
	Leak or loose connection in the patient circuit. Circuit disconnection from patient or ventilator.	Check the patient circuit connections to the ventilator; examine all connections for leakage and tightness. Replace the patient circuit if necessary.
	Inspiratory flow exceeds 130 LPM.	Check Min PIP alarm setting. Adjust Apnea alarm setting.
	Inappropriate patient circuit.	Replace with an appropriate circuit.
	Defective internal circuits of the machine or pressure sensor.	Restart ventilator to see if alarm clears. If not, contact your customer service representative to arrange for a qualified technician to replace the defective component or components.
POWER FAULT RESTART/SRVC	Internal problem in the electrical power supply.	Restart ventilator to see if alarm clears. If not, replace the ventilator. Contact your customer service representative for assistance.
POWER SUPPLY LOSS (without message)	Electrical power supply cut off by the main switch when ventilation is in progress.	Press the I/O (power) switch to restore electrical power to the ventilator and allow ventilation to continue.  To stop ventilation, press the VENTILATION ON/OFF button for 3 seconds, then release it. Press the VENTILATION ON/OFF button again to confirm stop (see Chapter 7, <i>Operating Procedures</i> ).
	The internal battery that supplies the ventilator is entirely discharged.	Immediately connect the ventilator to an AC power outlet or an external DC power source; otherwise, use an alternate device to ventilate the patient.
PRES SENS FLT1 RESTART/SRVC	Defective internal pressure sensor.	Restart ventilator to see if alarm clears. If not, contact your customer service representative to arrange for a qualified technician to replace the defective component or components.
PROX SENS FLT2 RESTART/SRVC	Defective proximal pressure sensor or internal leak of the machine.	Restart ventilator to see if alarm clears. If not, contact your customer service representative to arrange for a qualified technician to replace the defective component or components.
REMOVE VALVE OR CHANGE PRES	The ventilation settings are not compatible with the type of patient circuit used.	Remove exhalation valve to start ventilation with less than 5 mbar of difference between PEEP and Pi or increase the difference between PEEP and Pi to a minimum of 5 mbar.
REMOVE VALVE CPAP MODE	The ventilation settings are not compatible with the type of patient circuit used.	Remove exhalation valve to start CPAP ventilation.
SOFTWARE VERSION ERROR	Incorrect software version detected.	Contact your customer service representative.
TURB OVERHEAT RESTART/SRVC	Turbine overheated because of blockage during operation.	Ensure lateral and front openings are not obstructed. Check air inlet filter.  Restart ventilator to see if alarm clears. If not, replace the ventilator. Contact your customer service representative for assistance.
UNKNOWN BATTERY	Internal battery not recognized as a Puritan Bennett™ product battery.	Contact your customer service representative.



**Table 5-2.** Alarms and Corrective Actions (Continued)

Alarm message or symptom	Possible reason for the alarm event	Corrective action
VALVE MISSING CONNECT VALVE	The ventilation settings are not compatible with the type of patient circuit used.	Connect exhalation valve.
VTI NOT REACHED *IF PERSISTS RESTART/SRVC	Defective inspiratory flow sensor or internal leak of the machine.	Restart ventilator to see if alarm clears. If not, replace the ventilator. Contact your customer service representative for assistance.
	I time is not long enough to deliver set VT.	Increase I time or decrease VT.

### 5.9.2 Additional Troubleshooting

Table 5-3 provides other possible ventilator problems, causes, and corrective actions.



**WARNING:**

If the device is damaged, its external housing is not correctly closed, or it behaves in a way that is not described in this manual (excessive noise, heat emission, unusual odor, alarms not triggered during the start-up procedure), the oxygen and power supplies should be disconnected and use of the device stopped immediately.



**WARNING:**

If you cannot determine the cause of the problem, contact your equipment supplier. Do not use the ventilator until the problem has been corrected.



**Note:**

Buzzer and battery alarms may occur when the unit is first powered on after the internal battery has been completely drained. Connect to an AC power source and recycle power.

**Table 5-3.** Additional Troubleshooting and Corrective Actions

Conditions	Possible causes	Corrective actions
No access to the waveforms	Display waveform set to OFF in Preferences menu.	Set Display waveform to YES in Preferences menu (see section 7.3, <i>Preferences Menu Parameters</i> ).
The screen backlight never switches off during ventilation	Backlight set to YES in Preferences menu.	Set Backlight to OFF in Preferences menu (see section 7.3, <i>Preferences Menu Parameters</i> ).
Alarm sound level too low or too high	Adjustment of the alarm sound level is incompatible with the patient's environment.	Readjust sound level (see section 7.3, <i>Preferences Menu Parameters</i> ).
Poor visibility of the displays	Contrast adjustment is incompatible with the luminosity of the environment.	Readjust contrast (see section 7.3, <i>Preferences Menu Parameters</i> ).
Unusual display on the screen	Problem with the display unit.	Ensure that the ventilator is not exposed to direct radiation from the sun. Adjust contrast or call your customer service representative if the problem persists.

**Table 5-3.** Additional Troubleshooting and Corrective Actions (Continued)

Conditions	Possible causes	Corrective actions
The ventilator does not operate after pressing I/O (power) switch	No external power source and the internal battery is completely discharged.	Connect the ventilator to the AC power source.
Light noise	Turbine noise.	Replace the ventilator. Contact your customer service representative for assistance.
Whistling noise or vibrations	Filter, turbine silencer, or both have deteriorated.	Replace the ventilator. Contact your customer service representative for assistance.
	Valve membranes damaged.	Replace the ventilator. Contact your customer service representative for assistance.
Excessive heat emitted	Obstruction of main or secondary air inlets of the casings.	Remove obstructions from all blocked ventilator air inlets and outlets.
Condensation inside the device	Liquid entered the device.	Replace the ventilator. Contact your customer service representative for assistance.

# 6 Installation and Assembly



**WARNING:**

Before operating the ventilator, read, understand, and strictly follow the information contained in Chapter 1, *Safety Information*.



**WARNING:**

A patient treated by mechanical ventilation is highly vulnerable to the risks of infection. Dirty or contaminated equipment is a potential source of infection. Clean the ventilator and its accessories regularly and systematically before and after each use and following any maintenance procedure to reduce the risks of infection. The use of a bacterial filter at the ventilator's outlet (TO PATIENT) port—or both ports if a double-limb circuit is used—is highly recommended. Refer to Chapter 9, *Cleaning*.

## 6.1 Ventilator Startup Procedure

**To set up the Puritan Bennett™ 560 ventilator and start ventilation:**

1. Choose an area where air can circulate freely. Avoid proximity to loose fabrics, such as curtains, and direct exposure to sunlight.
2. Set the ventilator on a flat and stable surface so that its feet are all in contact with the surface. The ventilator may operate in any position, provided that the air inlets are not obstructed and the device cannot fall and possibly cause damage, personal injury, or both.
3. Assemble and connect the patient circuit (see section 6.4.2, *Installing the Patient Circuit*), including the following:
  - a. Air inlet filter (see section 6.5.1)
  - b. Bacteria filter (see section 6.5.2)
  - c. Humidifier (if used) (see section 6.6)
  - d. Oxygen sensor (see section 6.8.3)
4. Connect the oxygen supply to the ventilator. See section 6.8.2, *Connecting the Oxygen Supply*.
5. For instructions on switching to and operating from the internal battery, see section 8.2, *Battery Operation*. For instructions on connecting to DC power, see section 6.3, *Connecting to an External DC Power Source*.
6. Confirm proper functioning of alarms. For testing instructions, see Appendix F, *Alarms Tests*.
7. Turn on the ventilator. See section 7.1, *Turning on the Ventilator*.

8. Begin ventilation. See section 7.11, *Starting Ventilation*.



**WARNING:**

The operator should connect the ventilator to an AC power source whenever available, for safer operation.



**WARNING:**

To ensure correct and lasting operation of the ventilator, ensure that its air circulation holes (main inlet or cooling) are never obstructed. Place the device in an area where air can freely circulate around the ventilator and avoid installing it near floating fabrics, such as curtains.



**WARNING:**

Do not place the ventilator in a position where a child, pet or pest can reach it, or in any position that might cause it to fall on the patient or someone else.



**WARNING:**

Ensure that the ventilator's immediate surroundings allow for the proper operational connection of the device without folding, pinching, or damaging any of the required cables or tubes, and that the connection of the patient circuit to the patient provides for a secure, comfortable fit.



**WARNING:**

Do not operate the ventilator in direct sunlight, near heat sources, outdoors, or near installations where liquid may pose a risk without first providing adequate protection for the device.



**WARNING:**

If the ambient temperature where the device is operated is greater than 35°C (95°F), the temperature of the patient circuit or the flow supplied at the device outlet may exceed 41°C (106°F), and the patient circuit may reach up to 60°C (140°F). This may lead to undesirable side effects for the patient. To avoid injury to the patient move the patient and the ventilator to a cooler location. For more information, contact Covidien.



**WARNING:**

To reduce the risk of a fire hazard, keep matches, lighted cigarettes, and all other sources of ignition (such as flammable anesthetics and/or heaters) away from the ventilator and oxygen hoses.



**WARNING:**

Even if the internal battery charging indicator is off, charging of the battery may sometimes be incomplete if the ambient temperature is above 40°C (104°F) because of the battery's internal heat safety device.



**WARNING:**

The use of any accessory other than those specified, with the exception of the power supplies or cables sold by Covidien, may lead to an increase in electromagnetic emissions or a decrease in the equipment

protection against electromagnetic emissions. If the ventilator is used adjacent to such accessories or stacked with such devices, the ventilator's performance should be monitored to verify normal operation.



**WARNING:**

The Puritan Bennett™ 560 ventilator requires special precautions for electromagnetic compatibility and should be installed and started according to the recommendations found in Appendix B, *Specifications*. In particular, the use of nearby mobile and portable communications equipment using radio frequencies, such as mobile telephones or other systems exceeding the levels set in the IEC/EN 60601-1-2 standard, may affect its operation. Refer to section B.10, *Manufacturer's Declaration*.



**WARNING:**

The ventilator must not use, nor be connected to, any anti-static or electrically conductive hoses, tubing, or conduits.

## 6.2 Connecting to External AC Power

The ventilator can use any of the following power sources:

- AC power from a suitable wall outlet
- DC power (12 to 30 volts)
- Internal battery power
- DC car adapter (cigarette lighter)

The ventilator will automatically select AC power for operation whenever AC power is available.



**WARNING:**

The power supply to which the ventilator is connected (both AC and DC) must comply with all current and applicable standards and provide electrical power corresponding to the voltage characteristics inscribed on the rear of the ventilator to ensure correct operation.



**WARNING:**

Ensure that the AC power cable is in perfect condition and not compressed. The device should not be turned on if the AC power cable is damaged.



**WARNING:**

Connect the external electrical power source by first connecting the power cable to the ventilator and then to the external power source. Follow the reverse procedure to disconnect the device from electrical power sources.

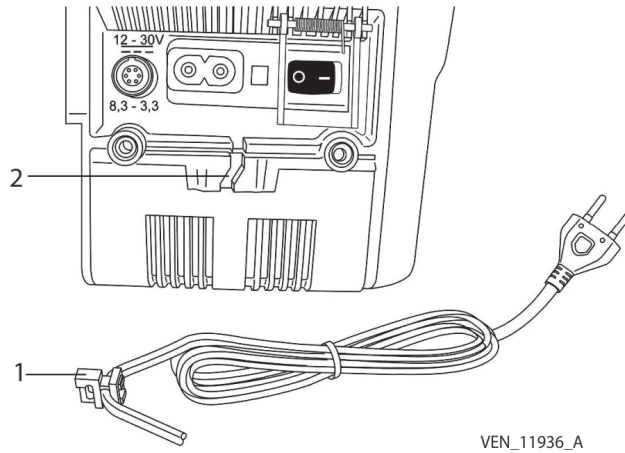


**WARNING:**

Do not leave power cables lying on the ground where they may pose a hazard.

To prevent accidental disconnection of the AC power cable, use the power cable holder that is inserted into the notch on the battery cover. See Figure 6-1.

**Figure 6-1.** The Power Cable Holder



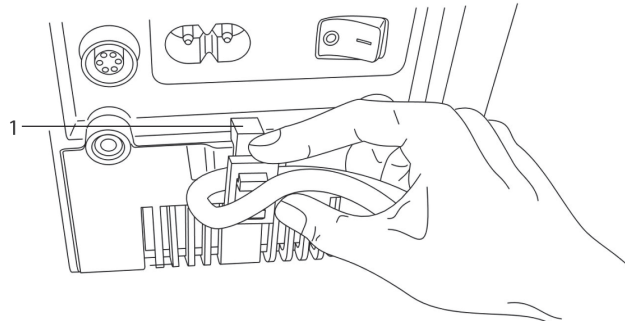
VEN\_11936\_A

- 1 Power cable holder
- 2 Notch on battery cover

**To secure the AC power cable:**

1. Insert the power cable holder into the notch on the battery cover. See Figure 6-2.

**Figure 6-2.** Inserting the Power Cable Holder into the Notch

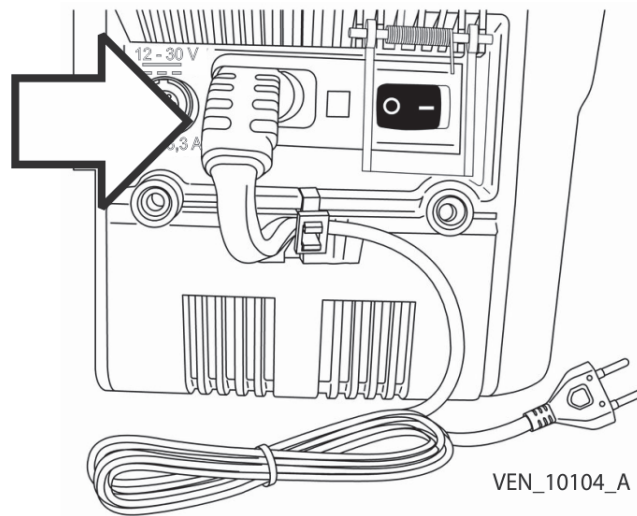


VEN\_11937\_A

- 1 Power cable holder

2. Connect the female end of the ventilator's AC power cable to the AC connector on the back of the ventilator.

**Figure 6-3.** Power Cable Connected to the Ventilator



3. Connect the male end of the AC power cable to the AC power outlet.



- The AC power indicator on the top left corner of the ventilator illuminates.



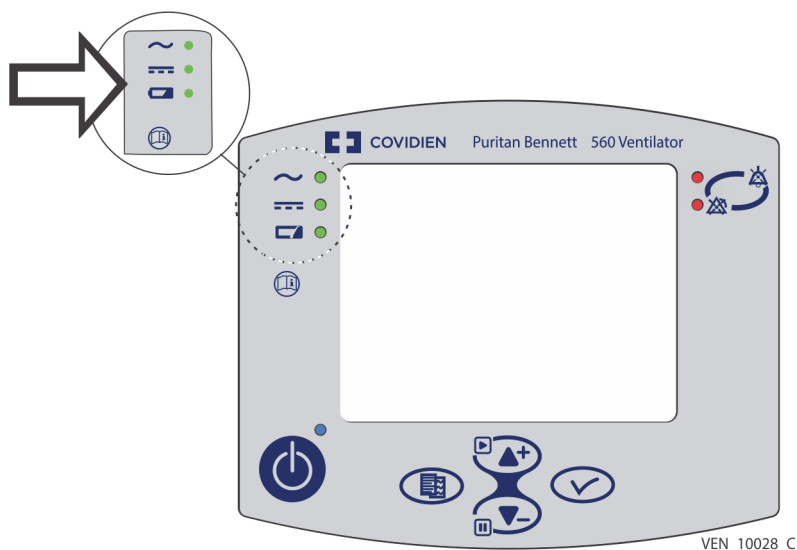
- The indicator flashes while the battery charges and then turns off when the battery is fully charged.

See Figure 6-4 on page 6-6.

If the AC power cable becomes disconnected or the AC power source fails, an AC Power Disconnection alarm signals an automatic switch to the external DC power source (if the DC power cable is connected) or to the ventilator's internal battery.

One of three power indicators, located on the upper left of the ventilator's front panel, illuminates to signal which of the possible power sources are currently in use by the device (see Figure 6-4).

Figure 6-4. Power Indicators



**Note:**

The only time the AC power indicator and other indicators are illuminated at the same time is when the ventilator is connected to an AC supply and the battery is charging (indicator is flashing).

**To disconnect the AC power cable:**

1. Disconnect the AC power cable from the AC power outlet.
2. Disconnect the AC power cable from the ventilator’s AC connector at the rear of the device.
3. Grasp the AC power cable at the level of the power cable holder and turn the cable clockwise while lifting it upwards and out of the holder.

### 6.3 Connecting to an External DC Power Source



**WARNING:**

Ensure that the ventilator’s internal battery is fully charged before connecting the ventilator to an external DC power source. Powering the ventilator using an external 12–30 VDC power source (via the DC power cable) does not enable charging of its internal battery.



**WARNING:**

When using a car auxiliary adapter (cigarette lighter) ensure the car has been started prior to plugging in the ventilator’s DC adapter.



**Note:**

An alternative means of ventilation should always be available, particularly when the patient is in transit or away from wall power.



**Note:**

While using the ventilator on external battery power it is vital that a qualified caregiver (capable of providing necessary corrective actions in the event of alarm conditions) is present.

Whenever AC power is unavailable, the ventilator can operate from a continuously powered external 12–30 VDC power source via a DC power cable that connects to the ventilator's DC power input receptacle. The DC auxiliary receptacle (cigarette lighter) in a personal vehicle can be used in this way to provide power to the ventilator.

**Note:**

When AC power is not available use an external DC power source prior to using internal battery power.

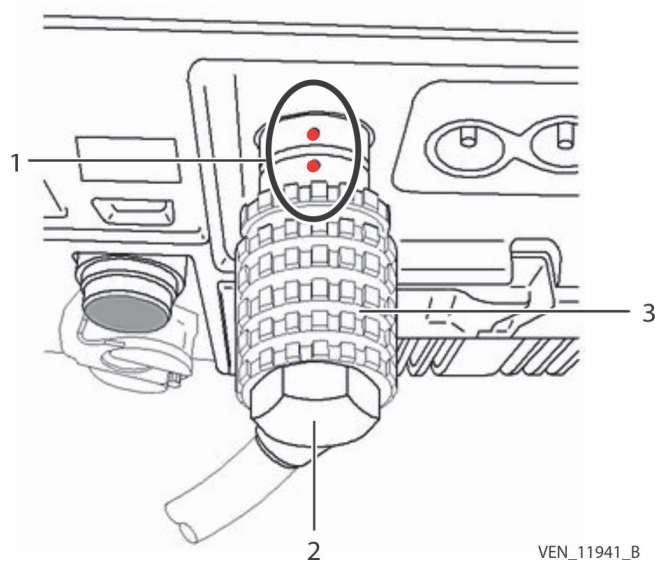
**Note:**

The DC power cable is optional; see Appendix *H, Parts and Accessories*, for more information.

**WARNING:**

**Connect the external DC power source by first connecting the power cable to the ventilator and then to the external DC source. Follow the reverse procedure to disconnect the device from the external DC power source.**

**Figure 6-5.** Connecting the DC Power Cable to the Ventilator



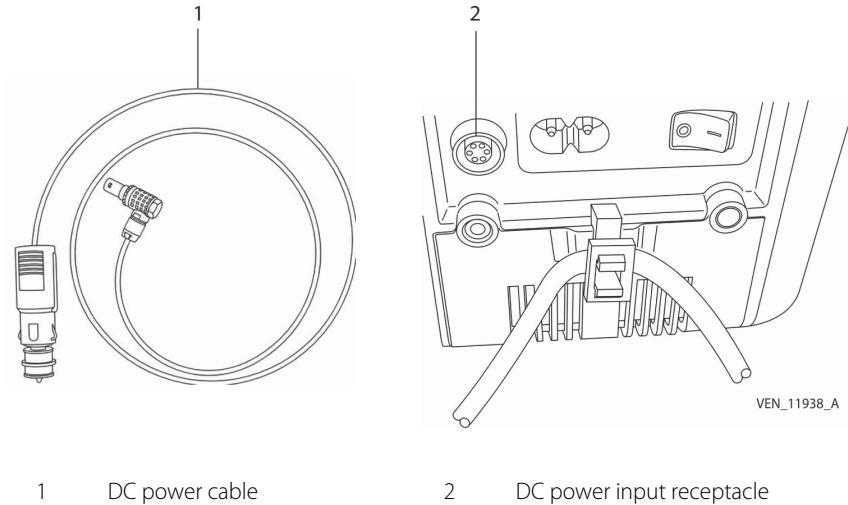
- |   |                          |   |                        |
|---|--------------------------|---|------------------------|
| 1 | Red alignment dots       | 3 | Connector locking ring |
| 2 | DC power cable connector |   |                        |

**To connect the DC power cable to the ventilator (see Figure 6-5):**

1. Line up the red alignment dots on the ventilator's DC power receptacle and on the DC power cable.
2. Push the DC power cable into the ventilator's DC power receptacle.

- You will hear a locking click.
- — —
- The DC power indicator on the top left corner of the ventilator illuminates (see Figure 6-4).

**Figure 6-6.** Connecting the Ventilator to an External DC Power Source



**To connect the ventilator to an external DC power source (see Figure 6-6):**

1. If using the DC auxiliary receptacle in a personal vehicle, ensure that the engine is started prior to connecting the ventilator.
2. Connect the smaller connector on the DC power cable into the DC power input receptacle on the rear of the ventilator.
3. Connect the larger connector on the DC power cable into the power source’s DC auxiliary receptacle.

If connecting the ventilator to the Puritan Bennett™ power pack external DC power source accessory, refer to accompanying documentation for the power pack.

**To disconnect the DC power cable from the ventilator (see Figure 6-5):**

1. Slide the locking ring back, away from the ventilator.
2. Pull the DC power cable connector out from the input receptacle to disengage it.

A DC Power Disconnection alarm signals an automatic switch to the internal battery if the external DC power source fails or becomes disconnected.

## 6.4 Patient Circuit

**WARNING:**

Before opening the packaging for the patient circuit, ensure that no damage is evident to the packaging or its contents. Do not use if evidence of damage exists.

**WARNING:**

For pediatric use, ensure that the patient circuit type fits, and, in all respects, is suitable for use with a child. Use a pediatric circuit for patients that weigh under 53 lb. (23 kg). For a list of recommended patient circuits, see [Table H-2](#).

**WARNING:**

If exhaled tidal volume measurements are required to ensure correct patient ventilation, a double-limb patient circuit configuration must be used in order to detect leaks. In this case, both the minimum and maximum VTE alarm parameters must be properly set to warn in the event of patient disconnection.


**WARNING:**

The patient circuit should always be positioned to avoid hindering the patient's movements, to prevent accidental disconnection or leakage, and to minimize the risk of patient strangulation.

**WARNING:**

Ensure that the ventilator's immediate surroundings allow for the proper operational connection of the device without folding, pinching, or damaging any of the required cables or tubes, and that the connection of the patient circuit to the patient provides for a secure, comfortable fit.

**WARNING:**

The patient circuit is intended for single use by a single patient  and should be changed according to the manufacturer's recommendations and according to the patient circuit lifetime. Refer to the instructions for use supplied by the manufacturer of the patient circuit (included with the ventilator) and Chapter 6, [Installation and Assembly](#).

**WARNING:**

After assembling, cleaning, or reassembling the patient circuit, and on a daily basis, inspect the hoses and other components to ensure that there are no cracks or leaks and that all connections are secure.

**WARNING:**

To ensure proper performance of the ventilator, use a patient circuit recommended by Covidien in this manual; refer to Chapter 6, [Installation and Assembly](#) and Appendix H, [Parts and Accessories](#). The total specified length of the patient circuit tubing as measured from the ventilator outlet to the ventilator inlet is 1.1 meters (3.6 feet) to 2.0 meters (6.6 feet). The tubing must conform to all applicable standards and must be fitted with Ø 22 mm terminals that also conform to all applicable standards. Ensure that both the length and the internal volume of the patient circuit are appropriate for the tidal volume: a corrugated tube of Ø 22 mm for adult patients, and a corrugated tube of Ø 15 mm for pediatric patients with a tidal volume lower than 200 ml.



**WARNING:**

**Adding accessories to the ventilator breathing circuit, such as a humidifier and water trap(s), may result in a decrease in tidal volume delivered to the patient due to the added compressible volume of the accessory. Always assure that the patient is receiving the appropriate inspired volume when altering the breathing circuit configuration.**



**WARNING:**

**Users must always possess an additional breathing circuit and exhalation valve while using the Puritan Bennett™ 560 ventilator.**

### 6.4.1 Choosing the Patient Circuit Type

Single-limb circuits are used with breathing modes where spirometry measurements are not required, and double-limb circuits are used with breathing modes where spirometry is required. Be sure to choose the appropriate circuit in the menu preferences; in particular, ensure that Pediatric Circuit Yes/No is set to YES when using a pediatric circuit (refer to Appendix *H, Parts and Accessories*).

For information regarding validated circuits, visit the SolvIT<sup>SM</sup> Center Knowledge Base by clicking the link at [www.medtronic.com/covidien/support/solvit-center-knowledge-base/](http://www.medtronic.com/covidien/support/solvit-center-knowledge-base/) or contact your customer representative.

### 6.4.2 Installing the Patient Circuit

The patient circuit is mounted depending on the setup of the circuit used and the accessories used.

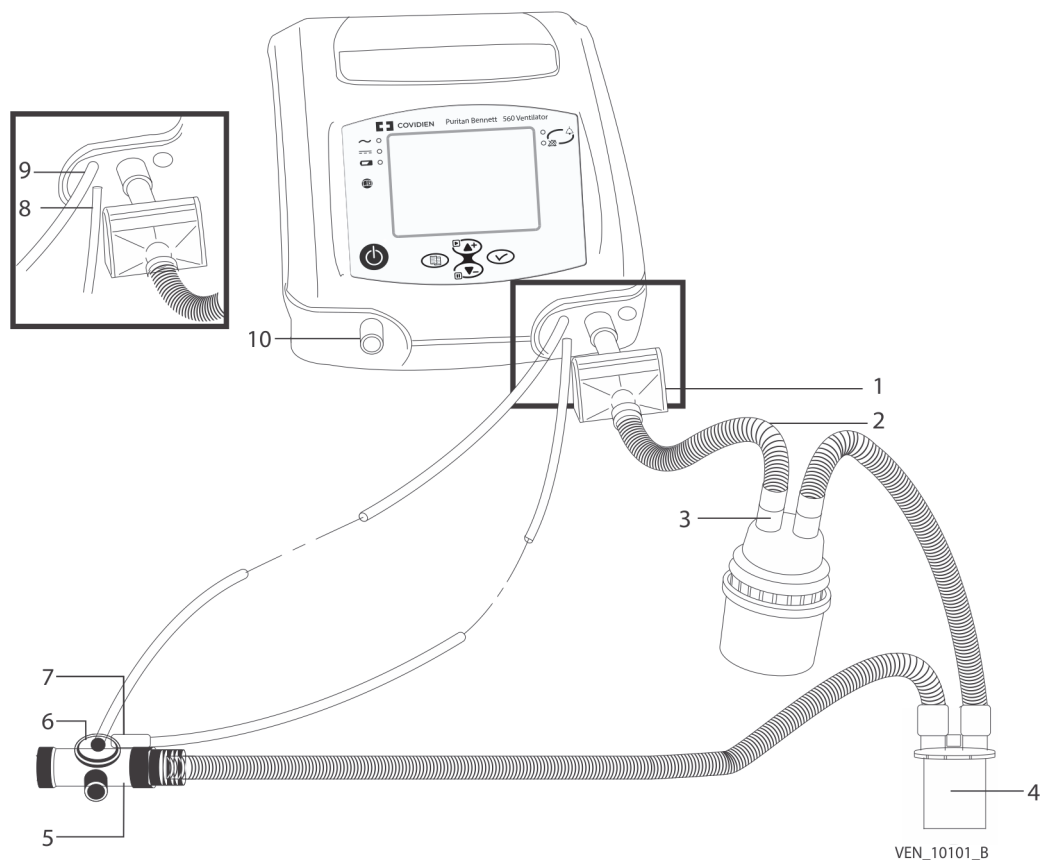


**Note:**

The following procedures describe the installation of the patient circuit with a humidifier, which is an optional accessory. To add other optional accessories not shown here, see the installation instructions for the specific accessories used.

## Single-Limb Circuit (With Exhalation Valve)

**Figure 6-7.** Single-Limb Patient Circuit With Exhalation Valve (including accessories)



- |   |                                 |    |                                |
|---|---------------------------------|----|--------------------------------|
| 1 | Inspiratory bacteria filter     | 6  | Exhalation valve tubing        |
| 2 | Short circuit tubing            | 7  | Proximal pressure tubing       |
| 3 | Humidifier (optional accessory) | 8  | Patient proximal pressure port |
| 4 | Water trap                      | 9  | Exhalation valve port          |
| 5 | Exhalation valve                | 10 | FROM PATIENT port              |



### Note:

Some breathing circuits include water traps that are already connected. If so, simply verify that the connection is secure and the tube shows no signs of damage, kinks, or obstructions.

### To connect a single-limb circuit with an exhalation valve (see Figure 6-7):

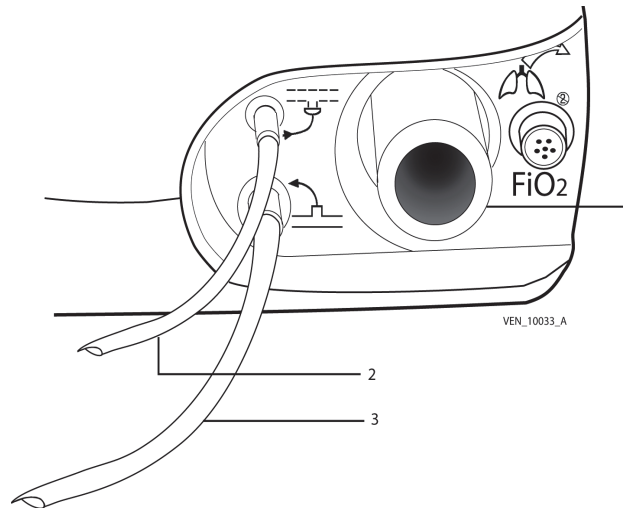
1. Inspect the components of the patient circuit for any signs of damage, such as cracks (which might cause leakage). Do not use damaged components to assemble the patient circuit.
2. Connect the proximal pressure tubing to the patient proximal pressure port on the ventilator. See Figure 6-8 for a detailed view.





3. Connect the exhalation valve tubing to the exhalation valve port on the ventilator. See Figure 6-8 for a detailed view.

**Figure 6-8.** Closeup of Exhalation Valve Tube and Proximal Pressure Tube



- |   |                       |   |                        |
|---|-----------------------|---|------------------------|
| 1 | TO PATIENT port       | 3 | Proximal pressure tube |
| 2 | Exhalation valve tube |   |                        |



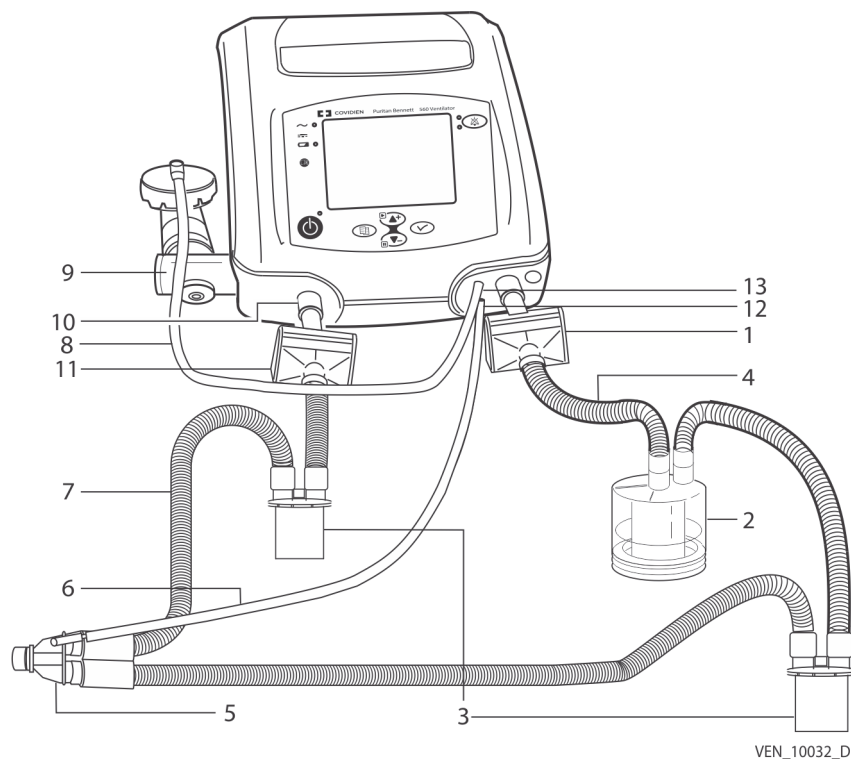
4. Connect the inspiratory bacteria filter to the TO PATIENT outlet port on the ventilator.
5. Connect one end of the short circuit tubing to the inspiratory bacteria filter.
6. Connect the other end of the short circuit tubing to the inlet port of the humidifier.
7. If it is not already in place, connect a water trap to the outlet port of the humidifier and to the patient circuit tubing.
8. Connect the patient circuit tubing to the other port on the water trap.
9. Ensure the exhalation valve is placed as close as possible to the patient.



10. To protect the FROM PATIENT port, as it is not used in this configuration, place the cap (if provided with the breathing circuit) over the port opening.

## Double-Limb Circuit

**Figure 6-9.** Double-Limb Patient Circuit (including accessories)



- |   |                                 |    |                                |
|---|---------------------------------|----|--------------------------------|
| 1 | Inspiratory bacteria filter     | 8  | Exhalation valve tubing        |
| 2 | Humidifier (optional accessory) | 9  | Exhalation valve assembly      |
| 3 | Water traps                     | 10 | Exhalation (FROM PATIENT) port |
| 4 | Short circuit tubing            | 11 | Exhalation bacteria filter     |
| 5 | Patient wye                     | 12 | Patient proximal pressure port |
| 6 | Proximal pressure tubing        | 13 | Exhalation valve port          |
| 7 | Double-limb circuit tubing      |    |                                |



**Note:**



When shipped, the proximal pressure tube may already be connected to the patient wye. If so, simply verify that the connection is secure and the tube shows no signs of damage, kinks, or obstructions.



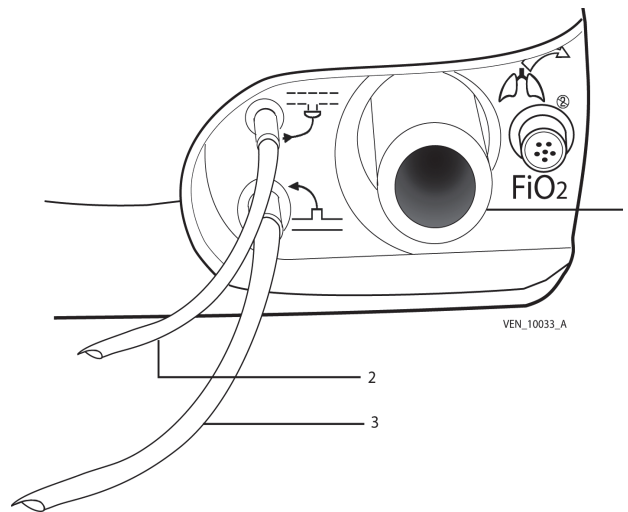
**Note:**

Some breathing circuits include water traps that are already connected. If so, simply verify that the connection is secure and the tube shows no signs of damage, kinks, or obstructions.



**To connect a double-limb circuit (see Figure 6-9):**

1. Inspect the components of the patient circuit for any signs of damage, such as cracks (which might cause leakage). Do not use damaged components to assemble the patient circuit.
-  2. Connect the proximal pressure tubing to the patient proximal pressure port on the ventilator. See Figure 6-10 for a detailed view.
3. Connect the exhalation valve assembly to the exhaled gas outlet on the left side of the ventilator, near the left front corner.
-  4. Connect the exhalation valve tubing from the exhalation valve assembly to the exhalation valve port on the ventilator. See Figure 6-10 for a detailed view.

**Figure 6-10.** Closeup of Exhalation Valve Tube and Proximal Pressure Tube



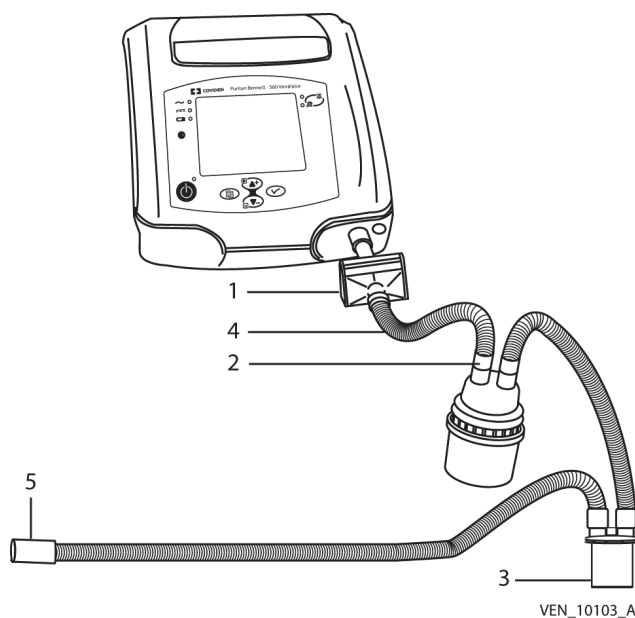
- |   |                       |   |                        |
|---|-----------------------|---|------------------------|
| 1 | TO PATIENT port       | 3 | Proximal pressure tube |
| 2 | Exhalation valve tube |   |                        |

-  5. Connect the inspiratory bacteria filter to the TO PATIENT outlet port on the ventilator.
6. Connect one end of the short circuit tubing to the inspiratory bacteria filter.
7. Connect the other end of the short circuit tubing to the inlet port of the humidifier.
8. If it is not already in place, connect a water trap to the outlet port of the humidifier and to one tube from the patient wye.
9. If it is not already in place, connect a second water trap to the other tube from the patient wye and to the inlet port of the exhalation bacteria filter.
-  10. Using a circuit adapter, connect the exhalation bacterial filter to the FROM PATIENT inlet port. See Figure 6-11.



**Figure 6-11.** Close-up of Exhalation Bacteria Filter Connection

### Single-Limb Circuit (Without Exhalation Valve)

**Figure 6-12.** Single-Limb Patient Circuit Without Exhalation Valve (including accessories)

- |   |                                 |   |                        |
|---|---------------------------------|---|------------------------|
| 1 | Inspiratory bacteria filter     | 4 | Short circuit tubing   |
| 2 | Humidifier (optional accessory) | 5 | Patient circuit tubing |
| 3 | Water trap                      |   |                        |

#### To connect a single-limb circuit without an exhalation valve (NIV only) (see Figure 6-12):

1. Inspect the components of the patient circuit for any signs of damage, such as cracks (which might cause leakage). Do not use damaged components to assemble the patient circuit.



2. Connect the inspiratory bacteria filter to the TO PATIENT outlet port on the ventilator.

3. Connect one end of the short circuit tubing to the inspiratory bacteria filter.
4. Connect the other end of the short circuit tubing to the inlet port of the humidifier.
5. If it is not already in place, connect a water trap to the outlet port of the humidifier and to the patient circuit tubing.
6. Connect a mouthpiece or vented (NIV) interface to the end of the patient circuit tubing.

For both types of circuits, connect the end of the proximal pressure tube as close as possible to the patient (at the mouthpiece, mask or cannula entry, if possible) so that the ventilator can account for all load losses due to the circuit and its potential accessories. If this is not possible, it is best to modify the patient disconnection triggering threshold by doing one of the following: Set a Max VTI alarm limit for pressure modes, or a Min VTE alarm limit for all ventilation modes if using a dual limb circuit.

**Note:**

Ensure that the length and the internal volume of the patient circuit are compatible with the tidal volume: Ringed tube Ø 22 mm for adults and ringed tube Ø 15 mm for pediatric patients with tidal volumes lower than 200 ml. Use, if necessary, a 22F-15M link on the outlet and a 15M-22M link on the exhalation block for a double-limb circuit.

**WARNING:**

**When using non-invasive ventilation (NIV), without an exhalation valve, use a vented nose or face mask or a non vented combined with a leak accessory. When using non-invasive ventilation (NIV), with an exhalation valve, use a non vented mask.**

**WARNING:**

**The level of inspiratory resistance of the circuit and accessories (bacteria filter, humidifier, and so on) must be as low as possible. Settings—particularly the Patient Disconnection alarm, high inspired volume (High VTI), and low inspired volume (Low VTI) settings—must be periodically adjusted according to changes in the patient circuit resistance—especially when filters are replaced.**

**WARNING:**

**Resistance of the exhalation valve and accessories (water traps, filters, HMEs, etc.) must be as low as possible.**

**WARNING:**

**The exhalation valve must allow rapid discharge of the circuit pressure. Ensure that the exhalation valve is always clean and its evacuation aperture (exhaust port) is never obstructed.**

**WARNING:**

**Do not start ventilation until you ensure that the device is suitably assembled, that the air inlet filter is properly installed and is not obstructed, and that there is proper clearance all around the unit. Also ensure that the patient circuit is suitably connected to both the ventilator and the patient and that the patient circuit, including all hoses, is not damaged or obstructed.**

**WARNING:**

Adding accessories to the ventilator breathing circuit, such as a humidifier and water trap(s), may result in a decrease in tidal volume delivered to the patient due to the added compressible volume of the accessory. Always assure that the patient is receiving the appropriate inspired volume when altering the breathing circuit configuration.

## 6.5 Filters

**WARNING:**

Regularly check the cleanliness of the air inlet filter located on the rear of the ventilator. If necessary, replace the filter before the recommended replacement period is over (see Chapter 10, *Routine Maintenance*). This is particularly important when the ventilator is installed on a wheelchair, because environmental conditions may cause the filter to become dirty more rapidly.

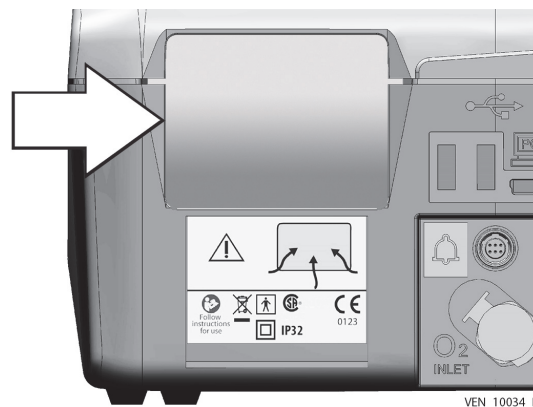
The ventilator features two filter types:

- Air inlet filter
- Bacteria filter

### 6.5.1 Air Inlet Filter

Consisting of foam and fine particle filter media and located at the rear of the ventilator, this filters the air as it enters the ventilator.

Figure 6-13. Air Inlet Filter

**WARNING:**

The air inlet filter is not reusable; do not attempt to wash, clean, or reuse it.

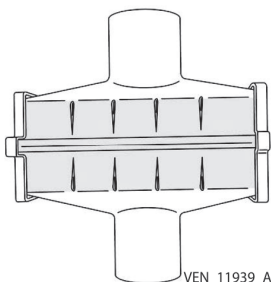
**WARNING:**

Failing to replace a dirty air inlet filter, or operating the ventilator without a filter, may cause serious damage to the ventilator.

### 6.5.2 Bacteria Filter

It is highly recommended that you install a bacteria filter (see Figure 6-14) on both single- and double-limb circuits.

**Figure 6-14.** Bacteria Filter



A single-limb configuration uses one bacteria filter, at the TO PATIENT port. A double-limb configuration uses two bacteria filters, one at the TO PATIENT port, and the other at the FROM PATIENT port.



- Connected to the TO PATIENT port: The filter protects the ventilator from contamination by the patient (primarily, rebreathed gas). See Figure 6-7 (item 1), Figure 6-9 (item 1), and Figure 6-12 (item 1). When connected here, the filter is called the inspiratory bacteria filter.



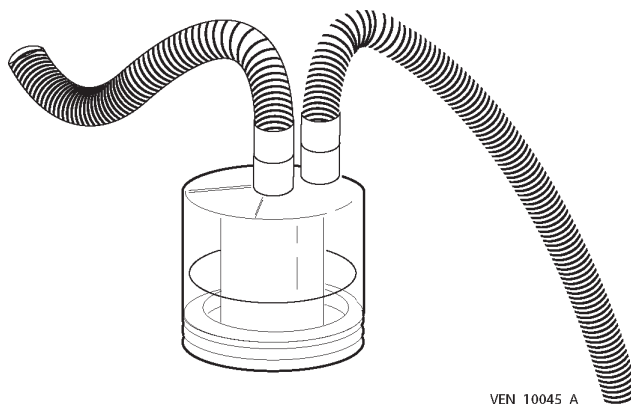
- Connected to the FROM PATIENT port: The filter protects the internal exhalation flow sensor from the gases exhaled by the patient. See Figure 6-9 (item 11). When connected here (using a circuit adapter), the filter is called the exhalation bacteria filter.

See the manufacturer’s instructions for more information about the use and maintenance of bacteria filters.

### 6.6 Humidifier

The humidifier (Figure 6-15) adds moisture (water vapor) and warms the gas in the patient circuit. It is inserted into the patient circuit between the TO PATIENT outlet port and the patient (see Figures 6-7, 6-9, and 6-12).

**Figure 6-15.** Humidifier



**WARNING:**

During invasive ventilation (when an artificial airway bypasses the patient's upper respiratory system), the patient's upper respiratory system cannot humidify the incoming gas. For this reason, the use of a humidifier, to minimize drying of the patient's airways and subsequent irritation and discomfort, must be used.

**WARNING:**

Always position a humidification device so that it is lower than both the ventilator and the patient. Use water traps, if necessary, to limit water in the patient circuit and periodically empty these water traps. Take precautions when discarding the fluid in the water trap. Discard per local ordinance for proper disposal.

**WARNING:**

If a heated humidifier is used, you should always monitor the temperature of the gas delivered to the patient. Gas delivered from the ventilator that becomes too hot may burn the patient's airway.

**WARNING:**

Adding accessories to the ventilator breathing circuit, such as a humidifier and water trap(s), may result in a decrease in tidal volume delivered to the patient due to the added compressible volume of the accessory. Always assure that the patient is receiving the appropriate inspired volume when altering the breathing circuit configuration.

When a humidification device is used, any condensation that forms in the patient circuit is collected in the water trap (or traps). If you notice any moisture in the patient circuit, you need to replace the wet circuit components with dry ones.

See the humidification device's instructions for information on operating, cleaning, and sterilizing the humidifier.


**Note:**

It is the user's responsibility to verify that any humidification system selected for use is compatible with the Puritan Bennett™ 560 ventilator.

## 6.7 Exhalation Block



### WARNING:

The exhalation block is intended for single use by a single patient . It may periodically be cleaned, but it cannot be disinfected or sterilized. To maintain good measurement quality when used continuously, clean the exhalation block periodically (see section 9.3, *Cleaning the Exhalation Block*). The exhalation block should be changed every 4 months and cannot be reused with any other patient.



### WARNING:

Ensure that the exhalation block is completely dried after cleaning and prior to use.

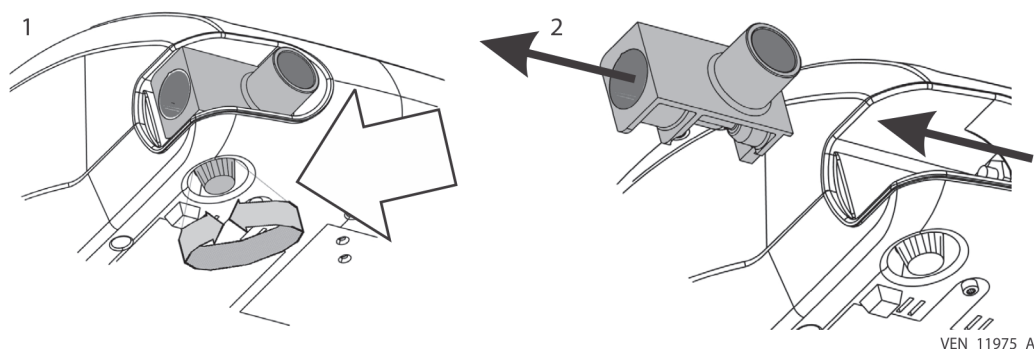


### WARNING:

When an exhalation block is set up, each time it is removed, or after installing a new exhalation block on the machine, it is essential that the exhalation flow sensor be recalibrated before the exhalation block is used. See section 10.3, *Calibrating the Exhalation Flow Sensor*.

The exhalation block can be easily removed from the device for inspection, cleaning, and replacement. No special tools are required. It is held in place by a single captive screw located on the bottom of the device.

Figure 6-16. Removing the Exhalation Block



### To remove the exhalation block (see Figure 6-16):

1. Ensure the ventilator is turned off.
2. Loosen the captive screw located on the bottom of the ventilator that secures the exhalation block (view 1). Grasp the exhalation port and slide the exhalation block to the left to remove it from its slot (view 2).
3. After removal, the exhalation block can either be cleaned or, if required, replaced with a new one. For information on cleaning, see section 9.3, *Cleaning the Exhalation Block*.

### To install either a cleaned or a new exhalation block (see Figure 6-16):

1. Slide the exhalation block into its slot.
2. Tighten the captive screw to secure the exhalation block in place.
3. Recalibrate the exhalation flow sensor. See section 10.3, *Calibrating the Exhalation Flow Sensor*.

## 6.8 Oxygen

### 6.8.1 Administering Oxygen

**WARNING:**

The ventilator must not be used with flammable anesthetic substances.

**WARNING:**

Oxygen therapy for patients with respiratory failure is a common and effective medical prescription. However, be aware that inappropriate oxygen use may potentially lead to serious complications, including, but not limited to, patient injury.

**WARNING:**

To avoid injury to the patient and/or possible damage to the ventilator: before using the ventilator, use a flow meter (flow regulator) to regulate the oxygen supply to specifications before connecting the ventilator to the oxygen supply.

**WARNING:**

Ensure that the oxygen supply pressure to the machine never exceeds 7 psi (50 kPa) or a flow of 15 lpm. Refer to Table B-8 for volume and sensitivity tolerances.

**WARNING:**

The Puritan Bennett™ 560 ventilator can be used with an optional oxygen analyzer with minimum and maximum concentration alarms. Always measure the delivered oxygen with a calibrated oxygen analyzer (FiO<sub>2</sub> kit) that features a minimum and maximum concentration alarm in order to ensure that the prescribed oxygen concentration is delivered to the patient.

Oxygen administered to the patient is introduced from an external source into the machine through the oxygen connector at the rear of the ventilator. It is then integrated into the total volume of delivered gas. Remove the oxygen inlet connector from the back of the ventilator when external oxygen is not in use.

The specific oxygen flow to the patient depends on the physiological characteristics of the patient and the ventilator settings.

The oxygen flow setting should be adjusted for each patient and established in relation to a calibrated oxygen monitor measurement. As the factors that affect administered oxygen flow may change over time, you must ensure that these settings always correspond to the current oxygen therapy objectives specified by the physician. (See section 3.8, *FiO<sub>2</sub> For Various Oxygen and Ventilator Settings*).

### 6.8.2 Connecting the Oxygen Supply



**WARNING:**

Ensure that the only gas supplied to the ventilator through the dedicated oxygen supply connector is medical-grade oxygen.

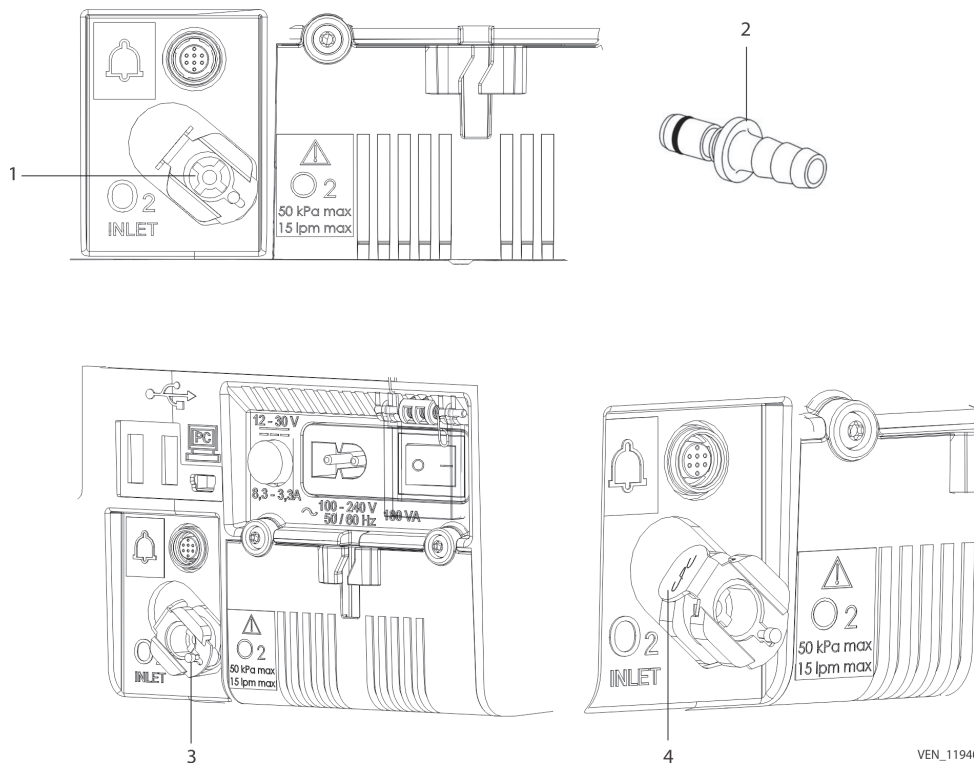


**WARNING:**

The hose connecting the ventilator to the oxygen source must be designed exclusively for use with medical-grade oxygen. Under no circumstances should the oxygen hose be modified by the user. In addition, the hose must be installed without the use of lubricants.

Refer to *Figure 6-17*. An inlet port for an external low pressure oxygen source is available at the rear of the ventilator. It is essential to also use the special coupler supplied with the ventilator to connect the external low pressure oxygen source to the ventilator. The inlet port is also fitted with a non-return airtight valve system, which includes a stud and a locking tab.

**Figure 6-17.** Rear Panel Oxygen Inlet Port and Coupler



- |   |                                |   |  |
|---|--------------------------------|---|--|
| 1 | O <sub>2</sub> inlet port      | 3 | O <sub>2</sub> inlet port locking stud |
| 2 | External oxygen supply coupler | 4 | O <sub>2</sub> inlet port locking tab  |

VEN\_11940



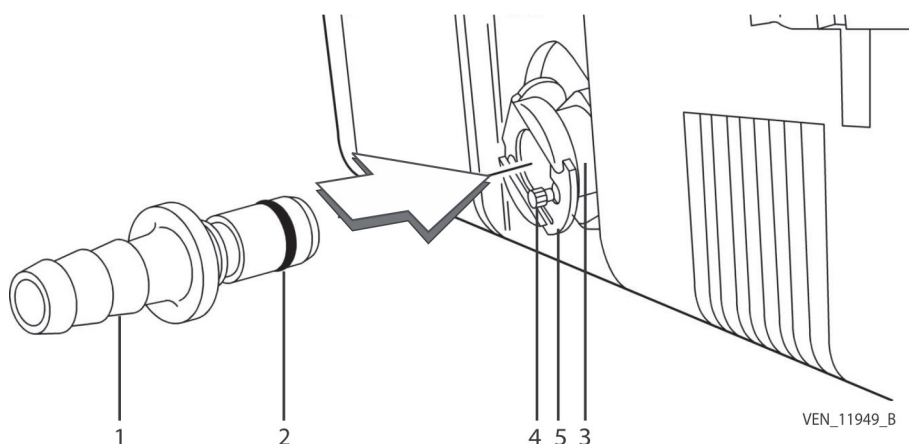
**WARNING:**

Before connecting the oxygen supply, ensure that the stud on the oxygen inlet (Figure 6-17, item 3) is protruding outwards.

**WARNING:**

Inspect the oxygen coupler (Figure 6-17, item 2) before use to ensure it has its black O-ring (Figure 6-18, item 2) attached and in good condition. Do not use an oxygen coupler with a missing, damaged, or worn O-ring.

Figure 6-18. Connecting the Oxygen Supply



1	External oxygen supply coupler	4	Locking stud
2	Coupler O-ring	5	Locking tab
3	O <sub>2</sub> inlet port		

**To connect the oxygen supply to the ventilator (see Figure 6-18):**

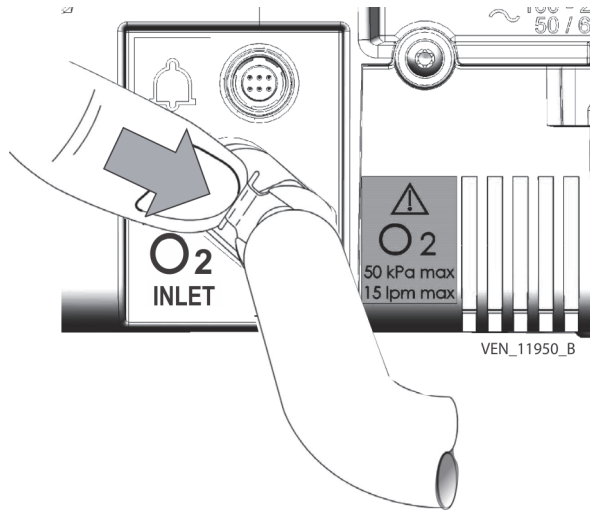
1. Inspect the oxygen supply coupler to ensure that the black O-ring is not missing.
2. Push the coupler into the O<sub>2</sub> inlet port on the ventilator. Ensure that the following occurs:
  - The locking stud on the inlet port retracts.
  - The locking tab on the inlet port is released, ensuring that the oxygen supply connection is locked and secured in place.

**To disconnect the oxygen supply from the ventilator:**

1. Ensure that the oxygen source is turned off prior to placing the ventilator in standby or turning off the ventilator.
2. Stop the oxygen flow from the oxygen supply.

3. Press the locking tab on the ventilator's O<sub>2</sub> inlet port to unlock the oxygen connection.

**Figure 6-19.** Disconnecting the Oxygen Supply



4. Disconnect the oxygen supply by pulling the coupler out from the inlet port.

The locking stud on the inlet port (Figure 6-18, item 4) will then extend outwards, which is required before the oxygen connector can be reconnected.



**WARNING:**

The coupler must not remain connected to the oxygen connector unless it also connected to a leak-proof, external oxygen gas source. When an oxygen supply is not being used with the ventilator, disconnect the oxygen source completely from the ventilator.



**WARNING:**

In the event of an oxygen leak, shut down the supply of oxygen at its source. In addition, remove and/or keep any incandescent source away from the device, which may be enriched with oxygen. Circulate fresh air into the room to bring the oxygen level down to normal.



**WARNING:**

To prevent any interference with the internal sensors of the ventilator, do not install a humidifier upstream of the ventilator.

### 6.8.3 Connecting the FiO<sub>2</sub> Sensor

When administering oxygen, it is recommended to use a FiO<sub>2</sub> oxygen sensor that can be connected by means of a FiO<sub>2</sub> measurement kit.



**Note:**

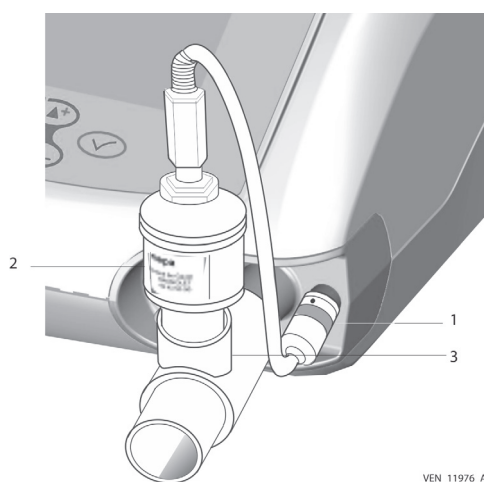
When using a new sensor, allow its temperature to become stable for about 20 minutes in ambient air before installing it, calibrating it, and starting ventilation.



**Note:**


A clinician or medical professional should be present when calibrating the FiO<sub>2</sub> sensor.

**Figure 6-20.** Connecting the FiO<sub>2</sub> Sensor



- |   |                                   |   |                        |
|---|-----------------------------------|---|------------------------|
| 1 | FiO <sub>2</sub> sensor connector | 3 | Proximal pressure tube |
| 2 | FiO <sub>2</sub> sensor           |   |                        |

**To install the FiO<sub>2</sub> sensor:**

1. Remove the sensor from the airtight packaging.
2. Connect the FiO<sub>2</sub> sensor connector to the FiO<sub>2</sub> receptacle on the ventilator.
3. Connect the FiO<sub>2</sub> sensor to a Ø15mm adapter.
4.  Connect the adapter to the TO PATIENT outlet port on the ventilator.
5. Fit the patient circuit and any accessories after the adapter. If a bacteria filter is present in the circuit, it should be placed just after the sensor, so that the sensor is directly between the ventilator and the bacteria filter.



**Note:**

For information on calibrating the sensor once it is installed, see *Calibrating the FiO<sub>2</sub> Sensor* on page 10-4.

## 6.9 Using the Dual Bag

The dual bag accessory allows the patient to carry the Puritan Bennett™ 560 ventilator on his or her back, and also allows it to be secured to the back of a wheelchair or to the seat of a personal vehicle.



**WARNING:**

Due to the internal battery's limited reserve capacity, the ventilator should only be operated on the internal battery when no other power source is available. Ensure that the internal battery never becomes fully discharged.



**WARNING:**

Do not operate the ventilator in direct sunlight, near heat sources, outdoors, or near installations where liquid may pose a risk without first providing adequate protection for the device.



**WARNING:**

To avoid damage to the ventilator, in particular the batteries or electrical components, fluids must not be allowed to enter the device, particularly through the air inlet filter or the cooling apertures located in the side, rear, and bottom panels of the ventilator.



**WARNING:**

If exhaled tidal volume measurements are required to ensure correct patient ventilation a double-limb patient circuit configuration must be used in order to detect leaks. In this case, both the minimum and maximum VTE alarm parameters must be properly set to warn in the event of patient disconnection.



**WARNING:**

To minimize the risk of damage, you must use the ventilator's dual bag to transport the ventilator. See [Table H-1](#).



**WARNING:**

Before using the ventilator's internal battery, ensure that the battery is fully charged and that the charge holds. Back up ventilators or those in storage should be connected to an AC power source to protect the integrity of the battery.

### 6.9.1 Fitting the Ventilator into the Dual Bag



**WARNING:**

Ensure that the ventilator is switched off and disconnected from all external power supplies before installation.

**To fit the ventilator into the dual bag:**

1. Disconnect the patient circuit from the ventilator.
2. Open the rear panel of the dual bag.

3. Slip the ventilator into the dual bag, front panel first. Push it in completely to ensure a snug fit.
4. Shut the rear panel of the dual bag ensuring that the hook and loop fastener strips are securely fastened.

If not mounting the dual bag on a wheelchair or in a personal vehicle, the patient circuit can be reconnected to the ventilator. See section 6.4.2, *Installing the Patient Circuit* for details.

### 6.9.2 Wearing the Dual Bag as a Backpack

To carry the ventilator using the dual bag as a backpack, put the straps over the patient's shoulders so that the bag sits comfortably on the patient's back. See Figure 6-21.

**Figure 6-21.** Using the Dual Bag as a Backpack



VEN\_12587\_A

### 6.9.3 Securing the Ventilator on a Wheelchair



**WARNING:**

Do not connect the ventilator to the battery of a battery-powered wheelchair unless the connection is listed in the instructions for use of the ventilator or the wheelchair, as this can affect the ventilator performance, which can consequently result in patient death.



**WARNING:**

Regularly check the cleanliness of the air inlet filter located on the rear of the ventilator. If necessary, replace the filter before the recommended replacement period is over. This is particularly important when the ventilator is installed on a wheelchair, because environmental conditions may cause the filter to become dirty more rapidly.

**Figure 6-22.** Using the Dual Bag on a Wheelchair (with double-limb circuit on left; with single-limb circuit on right)



VEN\_10985\_B

**To secure the dual bag onto a wheelchair with two push handles (see Figure 6-22):**

1. Facing the back of the wheelchair, loop each backpack strap over one of the push handles.
2. Attach the nonadjustable side of the maintaining belt to the side clip of the dual bag.
3. Pass the maintaining belt forward around the back of the wheelchair.
4. Attach the adjustable side of the belt to the clip on the other side of the dual bag. Adjust the length of the maintaining belt if needed to allow the belt to reach the clip.
5. Tighten the maintaining belt to secure the dual bag in place.

**To secure the dual bag onto a wheelchair with a single push handle:**

1. Unclip the two backpack straps from the side clips.
2. Clip the suspension belt onto the central ring.
3. Facing the back of the wheelchair, secure the dual bag on the wheelchair's push handle.
4. Attach the nonadjustable side of the maintaining belt to the side clip of the dual bag.
5. Pass the maintaining belt forward around the back of the wheelchair.
6. Attach the adjustable side of the belt to the clip on the other side of the dual bag. Adjust the length of the maintaining belt if needed to allow the belt to reach the clip.
7. Tighten the maintaining belt to secure the dual bag in place.

Once the dual bag is secured, the patient circuit can be reconnected to the ventilator. See section [6.4.2, \*Installing the Patient Circuit\*](#) for details.

## 6.9.4 Securing the Ventilator in a Personal Vehicle

**Figure 6-23.** Using the Dual Bag in a Personal Vehicle



VEN\_12643\_A

**To install the dual bag in a personal vehicle (see Figure 6-23):**

1. Unclip the two backpack straps from the side clips.
2. Clip the suspension onto the central ring.
3. Loop the suspension over the headrest of the front seat of the vehicle.
4. Attach the non-adjustable side of the maintaining belt to the side clip of the dual bag.
5. Pass the maintaining belt around the back of the front seat of the vehicle.
6. Adjust the length of the maintaining belt and attach the adjustable side of the belt to the clip on the other side of the dual bag.
7. Connect a 12V DC car adapter cable to charge the ventilator using the personal vehicle's battery. See section 6.3, *Connecting to an External DC Power Source*.

Once the dual bag is secured, the patient circuit can be reconnected to the ventilator. See section 6.4.2, *Installing the Patient Circuit* for details.



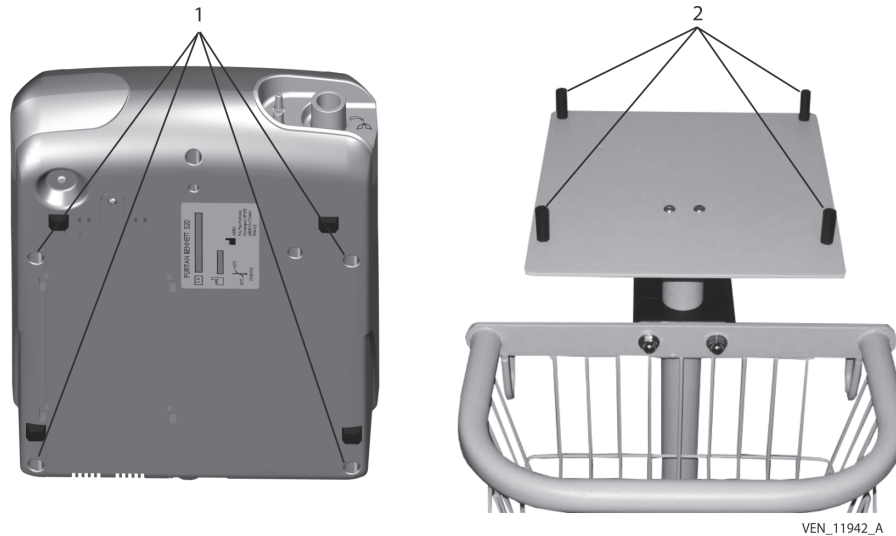
## 6.10 Mounting the Ventilator on a Utility Cart

As an alternative to using the dual bag for patient mobility, the Puritan Bennett™ 560 ventilator can be mounted on a utility cart.

### To mount the ventilator on the cart:

1. Match the mounting holes on the bottom of the ventilator to the mounting studs on the top of the utility cart platform. See [Figure 6-24](#).

**Figure 6-24.** Mounting the Ventilator on the Utility Cart



1 Mounting holes

2 Mounting studs

2. Pass the dual bag maintaining belt underneath the utility cart platform and over the top of the ventilator, then fasten the maintaining belt buckle. See [Figure 6-25](#).

**Figure 6-25.** Securing the Ventilator on the Utility Cart



3. Tighten the maintaining belt to secure the ventilator in place. See [Figure 6-26](#).



**Figure 6-26.** Puritan Bennett™ 560 Ventilator Mounted on Utility Cart



VEN\_10036\_C

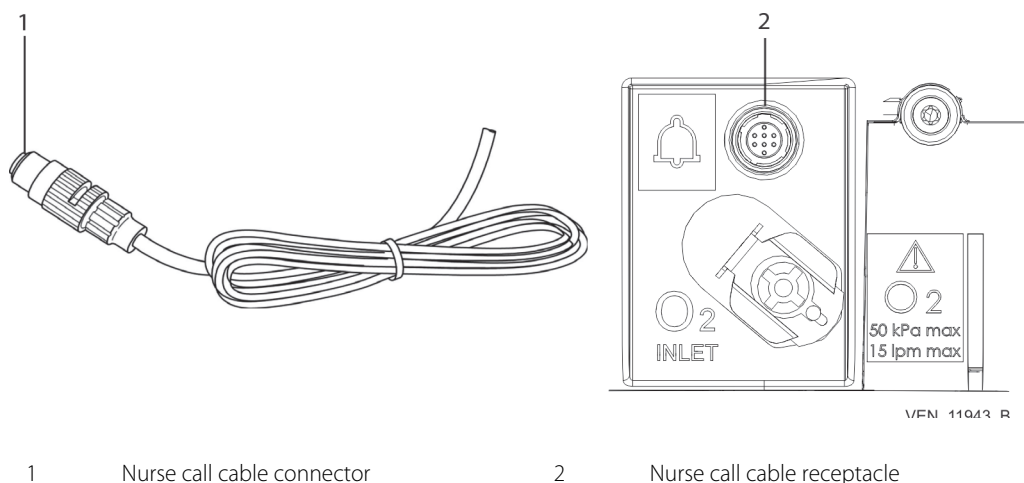
## 6.11 Connecting the Nurse Call Cable

**WARNING:**  
 Before using the nurse call system, ensure that its connections are secure and it operates properly. For more information, contact Covidien.

**WARNING:**  
 To connect the ventilator to a nurse call device, contact Covidien to check the ventilator's compatibility with the nurse call device and order a suitable connection cable.

**WARNING:**  
 Do not use nurse call devices that operate based on the closure of an electrical circuit, because the devices often do not take into account possible cable disconnection or a total loss of power. Ensure that the nurse call device is always connected to the ventilator.

Figure 6-27. Connecting the Nurse Call Cable



**To connect the nurse call cable (see Figure 6-27):**

1. Align the key feature on the nurse call cable connector (item 1) with the corresponding key feature in the nurse call cable receptacle on the rear of the ventilator (item 2).
2. Push the connector into the receptacle, taking care not to bend the connector pins.



**Note:**

The Puritan Bennett™ 560 ventilator has been designed to accommodate connectivity with nurse call/monitoring systems. Because it is not possible to anticipate every configuration of hardware and software associated with nurse call/monitoring system, it is the user's responsibility to confirm proper functionality of the system when used in conjunction with the ventilator. Verification of alarms, alerts, and patient data transmissions is required. If the system performance is not as expected, contact Technical Support for assistance troubleshooting the setup. Do not use the Puritan Bennett™ 560 ventilator with a nurse call/monitoring system until the functionality of the ventilator/system combination has been confirmed.

**Note:**

Complete a self-test after the cable has been installed and at regular intervals to ensure the system is operating as intended. A self-test consists of inducing an alarm and confirming the nurse call/monitoring system unit emits an audio alarm, and also confirming the audio alarm ceases once the alarm in the ventilator has been reset.

The nurse call function provides for remote alerts of ventilator alarm conditions (for example, when the ventilator is used in an isolation room), and features the following:

- The ventilator signals an alarm using a normally open (NO) or a normally closed (NC) signal.
- A remote alarm is activated when an alarm condition occurs, unless either of the following is true:
  - The audio paused function is active.
  - The ventilator power switch is OFF.
- The alarm delay, once generated from the ventilator, to the nurse call output/input cable connectors is less than 100 ms.
- The remote alarm port is an eight-pin female connector; allowable current is 100 mA at 24 VDC (max).

Page Left Intentionally Blank

# 7 Operating Procedures

## 7.1 Turning on the Ventilator



**WARNING:**

Before operating the ventilator, read, understand, and strictly follow the information contained in Chapter 1, *Safety Information*.



**WARNING:**

If the ventilator has been transported or stored at a temperature that differs more than  $\pm 20^{\circ}\text{C}$  ( $\pm 36^{\circ}\text{F}$ ) from the temperature in which it will be operating, the ventilator should be allowed to stabilize in its operating environment for at least 2 hours prior to use.



**WARNING:**

To reduce the risk of a fire hazard, keep matches, lighted cigarettes, and all other sources of ignition (such as flammable anesthetics and/or heaters) away from the ventilator and oxygen hoses.



**WARNING:**

While the ventilator is in use, an alternative means of ventilation should always be available in the event of a ventilator problem. This is particularly true for ventilator-dependent patients. Supplementary observation, appropriate for the patient's condition, is also recommended.



**WARNING:**

To ensure that ventilation continues uninterrupted, ensure alternative power sources are available (AC power source, extra batteries, or an auxiliary DC car adapter). Be prepared for the possibility of power failure by having an alternative means of ventilation ready for use—particularly for ventilator-dependent patients.



**WARNING:**

Do not start ventilation until you ensure that the device is suitably assembled, that the air inlet filter is properly installed and is not obstructed, and that there is proper clearance all around the unit. Also ensure that the patient circuit is suitably connected to both the ventilator and the patient and that the patient circuit, including all hoses, is not damaged or obstructed.



**WARNING:**

The time required to reach essential performance and start ventilation from power on is approximately 15 seconds.



**WARNING:**

Users must always possess an additional breathing circuit and exhalation valve while using the Puritan Bennett™ 560 ventilator.



**WARNING:**

Verify the functionality of the alarms before connecting the patient to the ventilator. Refer to Appendix *F, Alarms Tests*.



**WARNING:**

Before starting ventilation, always verify that all settings are properly set in accordance with the required prescription.



**WARNING:**

The ventilator offers a variety of breath delivery options. Throughout the patient's treatment, the clinician should carefully select the ventilation mode and settings to use for that patient, based on clinical judgment, the condition and needs of the patient, and the benefits, limitations, and characteristics of the breath delivery options. As the patient's condition changes over time, periodically assess the chosen modes and settings to determine whether those are best for the patient's current needs.



**WARNING:**

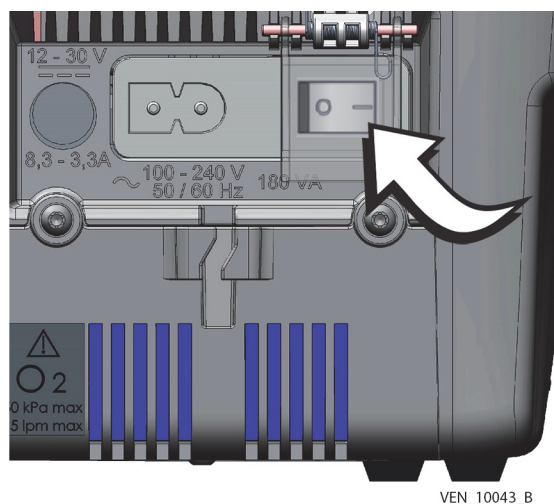
If the ventilator fails the alarm tests or if you cannot complete the tests, refer to section *5.9, Troubleshooting* or call your equipment supplier or Covidien.



**WARNING:**

Due to the internal battery's limited reserve capacity, the ventilator should only be operated on the internal battery when no other power source is available. Ensure that the internal battery never becomes fully discharged.

To turn the ventilator on, set the I/O (power) switch (a covered, rocker-type switch located at the rear of the ventilator) to the I position, as shown in *Figure 7-1*.

**Figure 7-1.** Turning on the Ventilator

VEN\_10043\_B

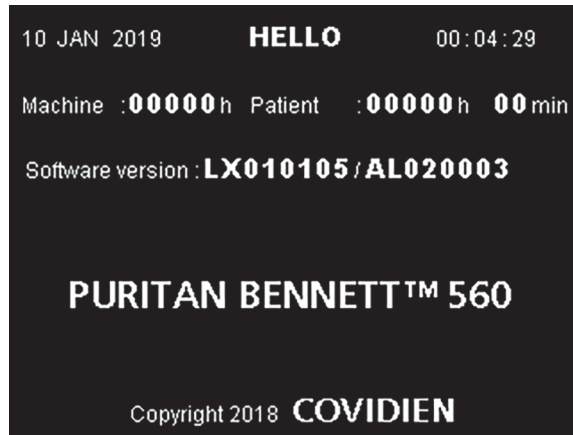
The following events occur:

- The ventilator is turned on.
- A Power On Self Test (POST) is carried out (when plugged in to an AC power source).
- The front panel indicators flash (except for the indicator showing the type of power supply in use, which remains lit).
- The audible alarms briefly sound.
- The display's backlight turns on.
- The Puritan Bennett™ logo is shown momentarily.
- The blue ventilator standby indicator (Figure 7-2, item 2) to the right of the VENTILATION ON/OFF button (Figure 7-2, item 1) illuminates, indicating the device is in standby mode.

**Figure 7-2.** VENTILATION ON/OFF Button and Standby Indicator

- A Welcome menu screen is shown for about 5 seconds, which includes the machine counter and the patient counter, as shown in [Figure 7-3](#).

Figure 7-3. Welcome Menu Screen



VEN\_12628\_A



**Note:**

If the ventilator had been previously stopped by use of the I/O (power) switch while ventilation was in progress, the ventilator starts directly in ventilation mode and does not show the Welcome menu screen.



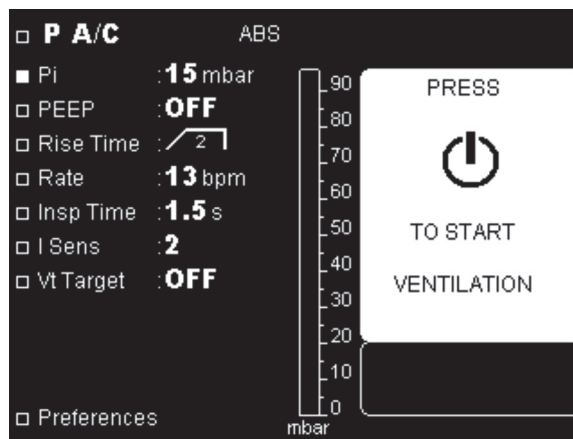
**Note:**

The alarm, technical fault, and event logs are stored in nonvolatile memory on the main CPU PCB, ensuring that the information is retained when the ventilator is powered off and during power loss conditions.



To skip the Welcome menu, press VENTILATION ON/OFF to start ventilation immediately. The Ventilation menu screen is then shown.

Figure 7-4. Ventilation Menu Parameters



VEN\_12055\_A

By default, the starting ventilation mode is the last one used, the settings being those that were active when the machine was last stopped.

If the ventilator's memory of the settings is faulty, a CHECK SETTINGS alarm is activated. If this occurs, the desired parameters should be reset and saved; otherwise the machine will operate on default parameter values.



## 7.2 Setup Menu Parameters

### 7.2.1 Accessing the Setup Menu



**Note:**

The Locking key prevents access to the Setup menu (see *Locking the Control Panel* on page 7-35 and *Unlocking the Control Panel* on page 7-35).



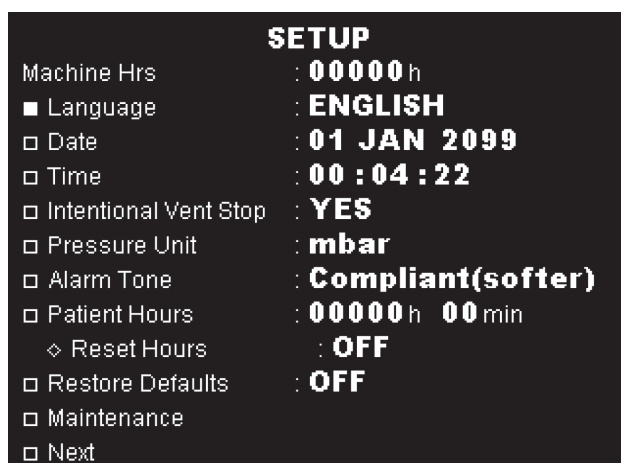
**Note:**

The Setup menu cannot be accessed if the ventilator had been turned off, without first placing the device into standby.



1. Check the ventilator's I/O (power) switch is set to the OFF (O) position.
2. Press and hold the ALARM CONTROL key while switching the I/O switch to the ON position (I). Hold the key until the Setup menu appears (approximately 3 seconds). See *Figure 7-5*.

**Figure 7-5.** Setup Menu



VEN\_12103\_A



3. Release the ALARM CONTROL key.

### 7.2.2 Changing the Setup Menu Parameters



**To change the Setup menu settings:**



1. Press UP or DOWN to position the cursor beside the parameter to be modified.
2. Press ENTER.



- The cursor changes to a plus-minus symbol.
- The selected parameter value flashes.



3. Press UP or DOWN to modify the value of the selected parameter.



4. Press ENTER to confirm the newly selected value.



If a parameter change is not confirmed by pressing ENTER before 7 seconds elapse, the ventilator resets the parameter to its previous value.



**Note:**

When a parameter contains several setup fields (such as for date and time) press ENTER  to move from one field to the next.

The parameters in this menu include the following:

- Machine Hours
- Language
- Date
- Time
- Intentional Vent Stop
- Pressure Unit
- Alarm Tone
- Patient Hours
- Restore Defaults
- Maintenance
- Next

### Machine Hours

The counter records the total ventilation time in hours (to the nearest hour) since manufacture.



**Note:**

The machine hour meter is reset when the CPU board is changed.

## Language

Set the language here. All messages and denominations in the user interface are shown in the selected language. The languages available are:

**Table 7-1.** Languages

English (US)	Finnish	Japanese
English (UK)	Russian	Italian
German	Portuguese	Greek
Danish	Polish	French
Chinese	Norwegian	Spanish
Turkish	Dutch	–
Swedish	Korean	–

## Date

Set the current date here. The date is shown in the format: DD MMM YYYY.

## Time

Set the current time here. The time is shown in the format: HH: MM: SS.

## Intentional Vent Stop Alarm

The Intentional Ventilation Stop alarm warns that ventilation has been switched off by the user or caregiver, and the ventilator is in standby.

### To set the Intentional Vent Stop Alarm:

1. Use the UP or DOWN arrows to place the cursor at the Intentional Vent Stop alarm position.
  2. Press ENTER.
  3. Press UP or DOWN to set the message to YES.
- Press ENTER to confirm the selection.

## Pressure Unit

Set the unit of pressure here. It can be shown as mbar, cmH<sub>2</sub>O, or hPa.

## Alarm Tone

Alarm tone options include Original (louder) or Compliant (softer). The default setting is Compliant. The audible sound of Compliant is softer than the Original tone, and meets the requirements of alarm standard 60601-1-8. Original refers to the alarm tone that was shipped with the ventilator from initial product launch until the LX010101/LX010023 software update.



**To change the alarm tone:**

1. Use the UP or DOWN arrows to place the cursor on Alarm Tone.
2. Press ENTER.
3. Use the UP or DOWN arrows to select Compliant or Original.
4. Press ENTER to confirm the selection.



**Patient Hours**

The value of this parameter is equal to the total number of hours that the patient has been ventilated.



**Note:**

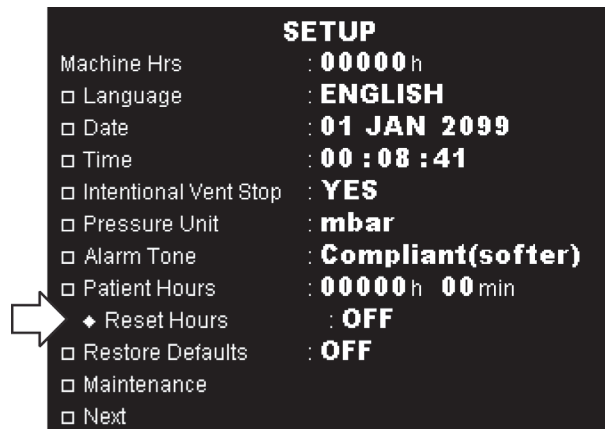
Resetting the patient hours will also reset the trends stored in the device memory in preparation for a new patient.

**To reset the Patient Hours counter to zero:**



1. Press DOWN to place the cursor at the Patient Hours line, as shown in Figure 7-6.

**Figure 7-6.** Resetting Patient Hours to Zero (1)



VEN\_11157\_A



2. Press ENTER.
  - The cursor is placed on the Reset Hours line.

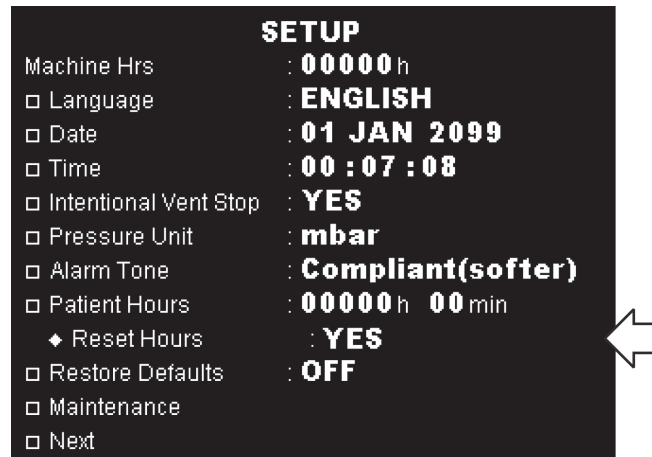


3. Press ENTER.
  - "OFF" flashes.



4. Press UP or DOWN to change the OFF message to YES, as shown in Figure 7-7.

**Figure 7-7.** Resetting Patient Hours to Zero (2)



VEN\_11158\_A



5. Press ENTER.

- "YES" is shown continuously.
- A long beep sounds.
- The patient counter display indicates 00000h, as shown in [Figure 7-8](#).

**Figure 7-8.** Resetting Patient Hours to Zero (3)



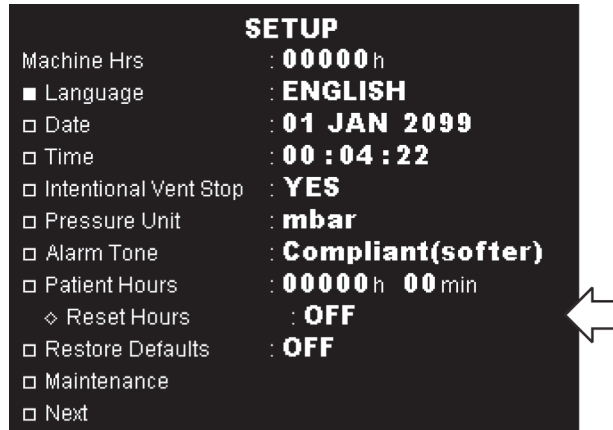
VEN\_11167\_A



6. Press UP or DOWN.

- The screen indicates "Reset Hours: OFF", as shown in *Figure 7-9*.

**Figure 7-9.** Resetting Patient Hours to Zero (4)



VEN\_11156\_A

### Restore Defaults

This allows the user to reset all settings back to the original manufacturer defaults except for the language, date, and time.



**To restore settings back to the manufacturer defaults:**

- Press UP or DOWN to position the cursor beside Restore Defaults, as shown in *Figure 7-10*.

**Figure 7-10.** Restoring Default Settings (1)



VEN\_12101\_A



- Press ENTER. "OFF" flashes.



- Press UP or DOWN to change OFF to YES, as shown in [Figure 7-11](#).

**Figure 7-11.** Restoring Default Settings (2)



VEN\_12102\_A



- Press ENTER to reset all settings back to the manufacturer defaults except for Language, Date, and Time. "OFF" will reappear, as shown in [Figure 7-12](#).

**Figure 7-12.** Restoring Default Settings (3)



VEN\_12101\_A

## Maintenance

This option is reserved for maintenance operators qualified by Covidien to ensure correct maintenance and operation of the device. For information on using the Maintenance option, refer to the service manual.

## Next

This allows the user access to Setup 2 menu. For more information, see section [7.2.3](#).

### 7.2.3 Entering Setup 2 Menu



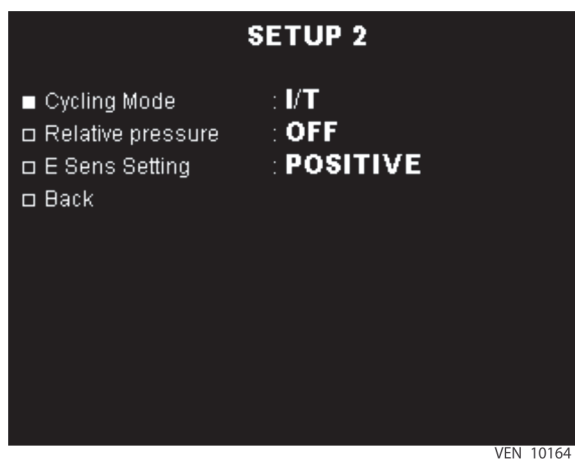
**To enter the Setup 2 menu:**

1. Press UP or DOWN to position the cursor beside NEXT.



2. Press ENTER. The Setup 2 menu is shown.

**Figure 7-13.** Setup 2 Menu



VEN\_10164\_C

The parameters in this menu include the following:

- Cycling mode
- Relative pressure
- E Sens Setting
- Back

#### Cycling Mode

The cycling mode is used to set which calculated value (I:E or I/T) appears in the parameter zoom window when changing Insp Time or Rate settings. It is also used to set the monitored data value (I:E or I/T) shown in the monitored data window and graphics screen.

The two cycling modes represent the relationship between inspiration time to exhalation time as follows:

1. I/T is inspiratory time (Ti) as a percentage of total breath cycle time (Ti + Te).

$$I/T (\%) = [Ti / (Ti+Te)] \times 100$$

2. I:E is the ratio of inspiratory time (Ti) to exhalation time (Te).

$$I:E = 1/(Te /Ti)$$

In P A/C and V A/C modes, the cycling ratio changes based on patient inspiration; however, the inspiratory time remains constant and corresponds to the rate and cycling ratio settings.



**Note:**

When adjusting I:E or I/T ratio, the corresponding calculated Ti is displayed below the parameter zoom in the monitoring and information window.

**Absolute and Relative Pressure**

The relative pressure for the inspiratory pressure setting (P Control and P Support) in PSV, P A/C, and P SIMV, can be set to OFF or YES and allows the choice between setting the inspiratory pressure relative to PEEP or setting an absolute inspiratory pressure. The default value is absolute (ABS).

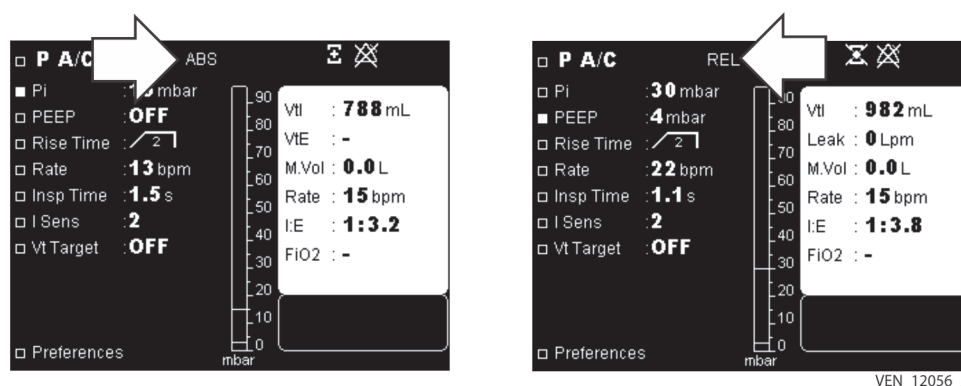
If relative pressure is set to YES, the PEEP is added to the inspiratory pressure setting to determine the peak inspiratory pressure. If relative pressure is set to OFF, the inspiratory pressure setting will determine the peak inspiratory pressure regardless of the PEEP setting.

Relative pressure = YES: Inspiratory pressure setting + PEEP = Peak inspiratory pressure

Relative pressure = OFF (ABS): Inspiratory pressure setting = Peak inspiratory pressure

The symbol ABS for absolute or REL for relative will be shown at the top of the screen as follows:

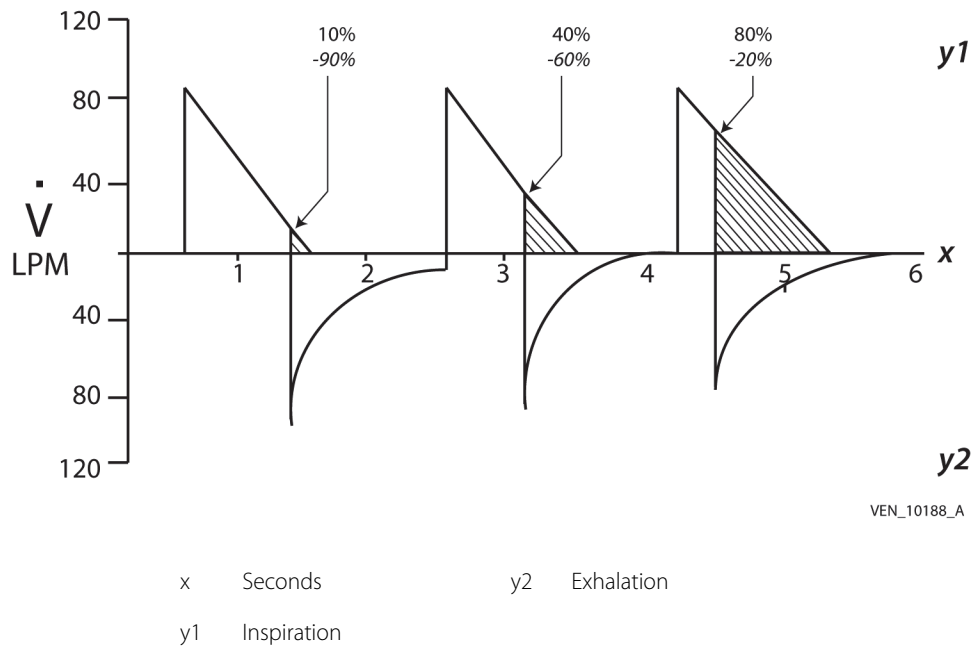
**Figure 7-14.** Absolute and Relative Pressure

**E Sens Settings**

E Sens enables the operator to adjust the sensitivity of the expiratory trigger in Pressure Support breaths in PSV, P SIMV and V SIMV modes which will cycle the breath into the expiratory phase. During a Pressure Support inspiration the delivered flow will reach a peak value and then begin to decelerate toward zero. The E Sens setting allows the operator to set the flow value, as a percentage of peak flow, that will cycle the breath to exhalation. The E Sens setting can be set to either POSITIVE or NEGATIVE.

If set to POSITIVE, E Sens is based on the percentage of inspiratory peak flow. If set to NEGATIVE, E Sens is based on the percentage of inspiratory peak flow by which the flow must decrease before exhalation is declared.

Figure 7-15. E Sens Settings



### Back

Allows the user to return to the Setup menu.

### 7.2.4 Exiting the Setup Menu

To exit the Setup menu, you must cycle the ventilator’s power.

1. Set the ventilator’s I/O (power) switch to OFF (O). Wait 30 seconds.
2. Set the I/O (power) switch back to ON (I).

The ventilator will run through a Power On Self Test (POST) routine and then return to standby mode.

## 7.3 Preferences Menu Parameters

The Preferences menu is only accessible if the Locking key has not been enabled (refer to [Locking the Control Panel](#) on page 7-35 and [Unlocking the Control Panel](#) on page 7-35).

The Preferences menu is accessed from the Ventilation parameters menu, when ventilation is either on or off.



#### WARNING:

Setting alarm limits to extreme values can cause the ventilator alarms to malfunction.



#### Note:

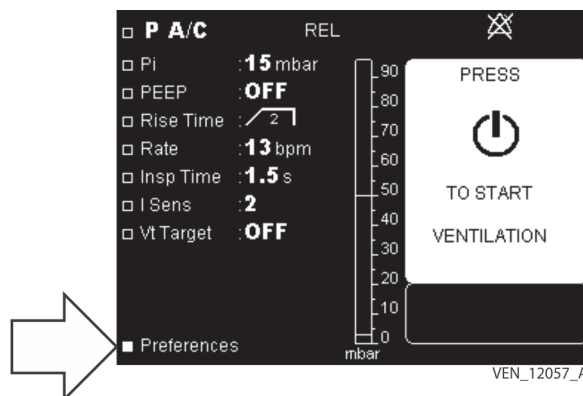
Default alarm setting preferences should be entered prior to using the ventilator.

### 7.3.1 Accessing the Preferences Menu

**To show the Preferences menu:**

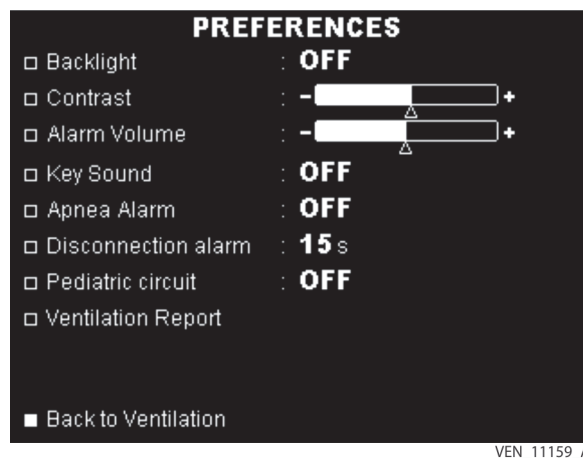
1. Press DOWN several times, or continue to press DOWN, until the cursor is on the Preferences line, as shown in *Figure 7-16*.

**Figure 7-16.** Selecting the Preferences Menu



2. Press ENTER. The Preferences menu is shown.

**Figure 7-17.** Changing Settings in the Preferences Menu (1)



### 7.3.2 Changing the Preferences Menu Parameters

**To change the settings in the Preferences menu:**

1. Press UP to place the cursor on the parameter line to be modified.
2. Press ENTER.
  - The cursor changes to the plus/minus symbol.
  - The parameter selected to be modified flashes, or for certain parameters featuring a bar graph, the indicator triangle under the bar graph becomes filled.

**Figure 7-18.** Changing Settings in the Preferences Menu (1)



- 1 Cursor (plus/minus symbol)
- 2 Parameter value: flashing
- 3 indicator triangle: filled



3. Press UP or DOWN to change the selected parameter's value.



4. Press ENTER to confirm the new parameter setting.

- The new parameter setting is shown.
- The cursor returns to its initial form.



If a parameter change is not confirmed by pressing ENTER before 7 seconds elapse, the ventilator resets the parameter to its previous value.

The parameters in this menu include the following:

- Backlight
- Contrast
- Alarm Volume
- Key Sound
- Apnea Alarm
- Disconnection Alarm
- Waveforms Display
- Pediatric Circuit
- Ventilation Report

To adjust the various Preferences menu parameters, or to view the Ventilation Report, refer to the instructions provided in this section.

## Backlight

### To set the backlight:

1. Select the Backlight parameter on the screen.
2. Set the backlight:
  - To set the backlight to standby, select OFF. The effect of this setting is that if no keyboard action occurs before 1 minute elapses, the display's backlight fades almost to off. The display will illuminate when the following occurs:

- Any one of the keys on the keyboard is pressed
- An alarm is triggered
- To set the backlight to light continuously, select YES. This setting ensures that the display is continuously lit.



**Note:**

If running the ventilator on its internal battery or on an external battery, we recommend keeping the backlight setting to OFF to reduce power consumption.

- 3. Press ENTER to confirm the new setting.

The default backlight setting is YES (backlight lit continuously).

**Contrast**

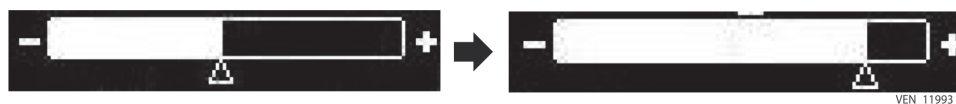
**To set the contrast:**

1. Select the Contrast parameter on the screen.
2. Set the contrast level:



- To increase the contrast, press UP. This change can be observed as the cursor moves to the right:

**Figure 7-19.** Increasing Contrast

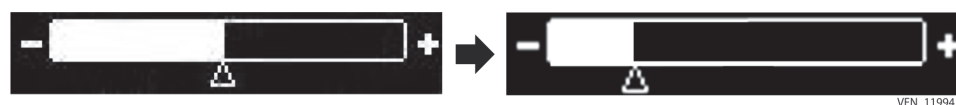


The display contrast progressively increases.



- To decrease the contrast, press DOWN. This change can be observed as the cursor moves to the left:

**Figure 7-20.** Decreasing Contrast



The display contrast progressively decreases.

- 3. Press ENTER to confirm the new setting.



When ventilation is stopped, the contrast can also be changed directly from the currently shown menu by pressing ALARM CONTROL continuously, while repeatedly pressing UP or DOWN.



The default contrast setting is the medium setting (the middle of the bar graph).

## Alarm Volume



### WARNING:

The sound level of the alarms should be adjusted according to the installation environment and the size of the area monitored by the patient’s caregiver. Ensure that the alarm sound apertures at the front of the device are never obstructed.

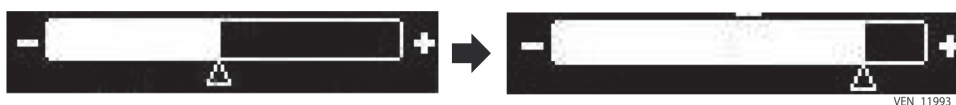
### To set the alarm volume:

1. Select the Alarm Volume parameter on the screen.
2. Set the alarm volume level:



- To increase the sound level of alarms, press UP. This change can be observed as the cursor moves to the right:

Figure 7-21. Increasing Alarm Volume

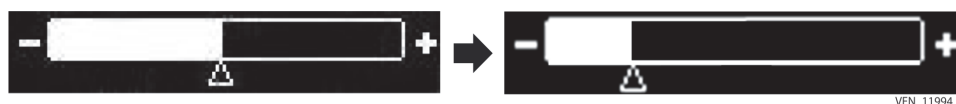


The buzzer activates and increases in sound level as the setting increases.



- To decrease the sound level of alarms, press DOWN. This change can be observed as the cursor moves to the left:

Figure 7-22. Decreasing Alarm Volume



The buzzer activates and decreases in sound level as the setting decreases.



3. Press ENTER to confirm the new setting.

Current hospital standards require a minimum sound level of 55 dB(A) at a distance of 3 meters (9.84 feet), which corresponds to the lowest possible volume setting. The alarm sound level range is described in section *B.3, Indicators and Alarms*. If a high priority alarm is not paused within 60 seconds of activation, the sound level automatically raises to the maximum level, regardless of the original setting.

The default setting for Alarm Volume corresponds to a level of halfway between the minimum and maximum values.

## Key Sound

This setting is used to select the sound emitted when pressing keys on the ventilator’s keyboard.

### To set the key sound:

1. Select the Key Sound parameter on the screen.

2. Select one of the following four options:

- OFF—No sound is emitted when a key is pressed
- Key tone—A click sounds when a key is pressed



- Accept tone—A beep sounds when ENTER is pressed to confirm a setting



- All tones on—A click sounds when all keys are pressed and a beep sounds when ENTER is pressed to confirm a setting



3. Press ENTER to confirm the new setting.

The default key sound setting is the Accept tone.



**Note:**

Whatever the selected key sound setting, pressing the VENTILATION ON/OFF key triggers a beep at ventilation start and a double beep at ventilation stop.

**Apnea Alarm**



**WARNING:**

**The Apnea Alarm should be set to YES for ventilator dependent patients.**

**To set the Apnea alarm:**



1. Use the UP or DOWN arrow keys to place the cursor at the Apnea Alarm position.



2. Press ENTER.

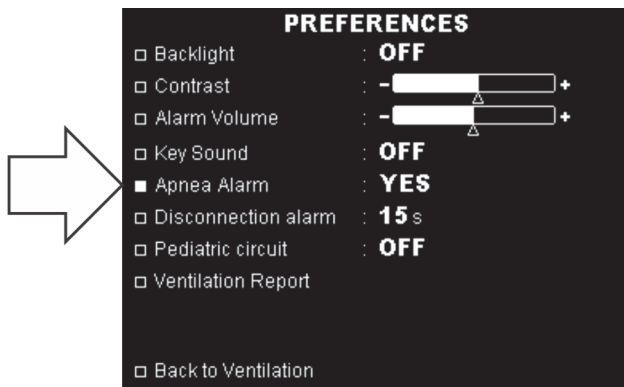


3. Press UP or DOWN to set the message to YES. Setting the key to OFF means the Apnea alarm will not sound when the ventilator is stopped.



4. Press ENTER to confirm the selection.

**Figure 7-23.** Setting the Apnea Alarm



VEN\_11160\_A



**Note:**

This activates/deactivates the Apnea alarm but not the apnea time setting. The apnea time setting can be set in the Ventilation menu.

**Disconnection Alarm**



**To set the Disconnection alarm:**

1. Use the UP or DOWN arrow keys to place the cursor at the Disconnection alarm position.
2. Press ENTER.
3. Press UP or DOWN to adjust the setting between 5 and 62 seconds.
4. Press ENTER to confirm the selection.



**Note:**

Values set in the ventilation mode may supersede disconnection alarm values. Refer to Chapter 5, *Alarms and Troubleshooting*.

**Waveforms Display**

**To set the waveforms display:**

1. Select the Waveforms Display parameter on the display.
2. Select either:
  - YES—Shows pressure and flow waveforms as a function of time (refer to section 4.4, *Waveform Display*).
  - OFF—Results in no waveform display; hence, no Waveform menu.
3. Confirm the new setting before 7 seconds elapse.

The default waveforms display setting is OFF.



Access the Waveform screen, on which the waveforms are shown, using the MENU key from the Alarm setting menu. This screen is available ONLY when ventilation is in progress.

**Pediatric Circuit**



**To choose a pediatric circuit:**

1. Use the UP or DOWN arrows to place the cursor at the Pediatric Circuit position.
2. Press ENTER.
3. Press UP or DOWN to set the message to YES. Setting the ventilator to OFF configures the device for an adult circuit.
4. Press ENTER to confirm the selection.



**Note:**

The default setting is OFF (the ventilator is set for adult use).

## Ventilation Report

**To access the Ventilation Report:**

1. Use the UP or DOWN arrows to place the cursor at the Ventilation Report position.



2. Press ENTER.

**Figure 7-24.** Accessing the Ventilation Report

VENTILATION REPORT	
Vent Time	8 h 0 min on 27 APR 2007
VtI	310 mL
VtE	310 mL
Paw	14 mbar
Rate	16 bpm
Leak	-
AI	10 Ew/h
Apnea TI	30 s
Spont cyc	98 %
Machine :	00012 h Patient : 00009 h 45 min
■ Back	

VEN\_12060\_A

**Note:**

The menu is shown for 5 minutes, then the screen reverts to the Preferences menu.



To exit the Ventilation Report, press ENTER.

### 7.3.3 Exiting the Preferences Menu



To manually exit from the Preferences menu, press ENTER when the cursor is on the Back to Ventilation.

You will automatically exit from the Preferences menu when:

- No keyboard action is detected before 15 seconds elapse, or
- A high priority alarm is triggered.

## 7.4 Setting the Ventilation Mode

The ventilation mode can be changed from the Ventilation parameters menu or the Alarm parameters menu, as long as the Locking key is not enabled (refer to *Locking the Control Panel* on page 7-35, and *Unlocking the Control Panel* on page 7-35).

The procedure to change the ventilation mode depends on the ventilation status, as described in section 7.4.1 and section 7.4.2.



**WARNING:**

In the SIMV mode the use of a double limb circuit is recommended. The VTE Min setting should remain active in the event that pressure losses are present on the patient circuit downstream from the proximal pressure link. In such cases the Patient Disconnection alarm would not be systematically activated in case of a disconnection of the circuit.



**WARNING:**

Most breaths are triggered by the patient. You should carefully modify the inspiration trigger threshold in order to avoid the risk of false triggering or “autotriggering” of the ventilator. For example, Level 0P, the most sensitive mode, is recommended for pediatric use. However, for an adult, this setting may result in autotriggering.

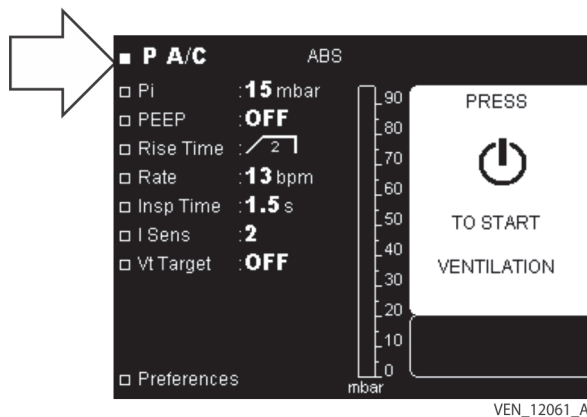
### 7.4.1 Changing Modes While Ventilation is on Standby

To change ventilation modes while on standby:



1. Place the cursor on the first line of the menu (general information line) using the UP key.

Figure 7-25. Changing Ventilation Modes While on Standby



2. Press ENTER.



- The cursor changes to a plus-minus symbol.
- The mode name flashes.



3. Press UP or DOWN until the required mode is shown.

4. Press ENTER to confirm the mode selected.
    - The cursor returns to normal.
    - The new mode is shown with its ventilation parameters.
- ⊗ If the ventilation mode change is not confirmed by pressing ENTER before 7 seconds elapse, the ventilator restores the previous mode.

## 7.4.2 Changing Modes During Ventilation



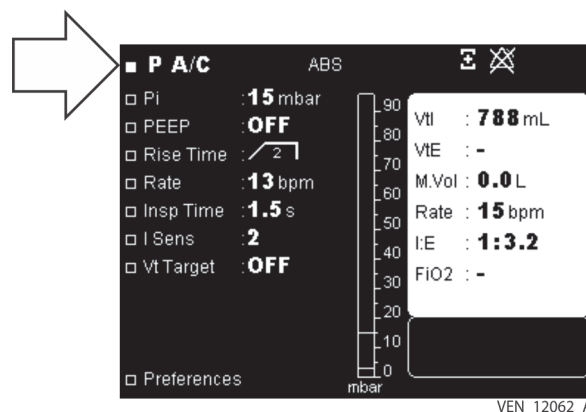
### WARNING:

When changing the mode during ventilation, significant transitions of pressure, flow or cycling rate might occur, depending on the difference between the modes. Before setting the new mode, first ensure that the settings between the different modes are compatible. This reduces the risk of discomfort and harm to the patient.

### To change ventilation modes during ventilation:

1. Place the cursor on the first line of the menu (general information line) using the UP key.

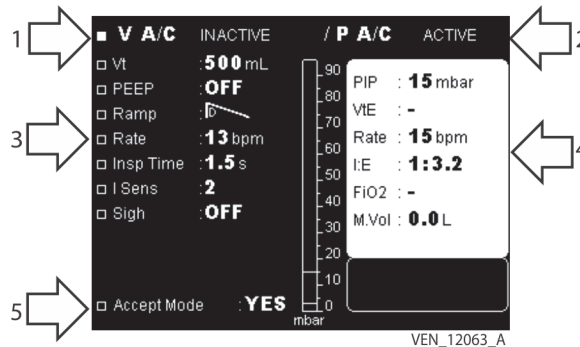
Figure 7-26. Changing Ventilation Modes During Ventilation (1)



2. Press ENTER.
  - The cursor changes to a plus-minus symbol.
  - The mode name flashes.
3. Press UP or DOWN until the required mode is shown.
4. Press ENTER to confirm the mode selected.
  - The name of the new mode selected is shown at the top left followed by the flashing INACTIVE status indicator (Figure 7-27, item 1).
  - The name of the mode in progress is shown at the top right followed by the continuous ACTIVE status indicator (Figure 7-27, item 2).

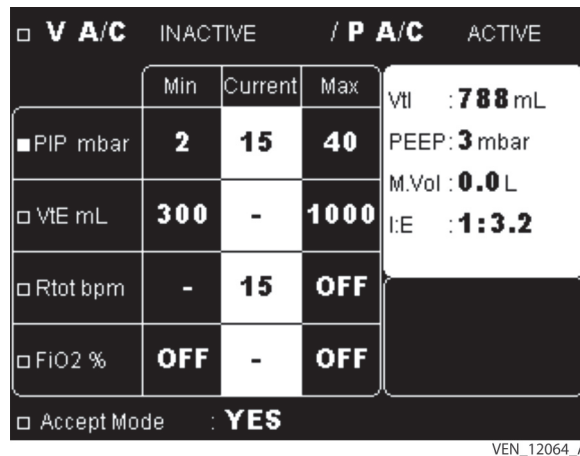
- The settings for the new mode are shown on the left (Figure 7-27, item 3) and the monitored values for the mode in progress on the right (Figure 7-27, item 4).
- The confirmation line “Accept Mode: YES” is shown on the bottom left (Figure 7-27, item 5).

**Figure 7-27.** Changing Ventilation Modes During Ventilation (2)



The Alarm menu screen in Figure 7-28 indicates the same active and inactive mode information being shown, along with the Accept Mode: Yes line, alarm parameter settings, and patient values.

**Figure 7-28.** Changing Ventilation Modes During Ventilation (3)



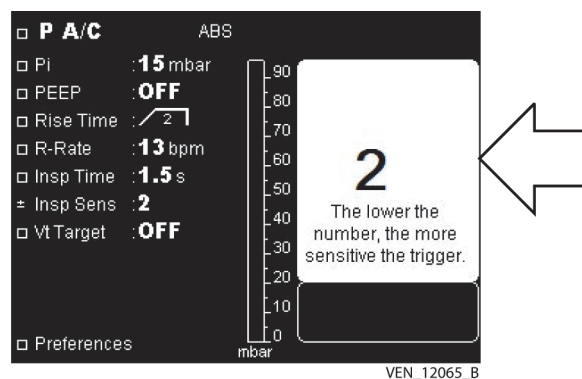
5. Change the settings of the new mode, including alarms, if necessary.
6. Press DOWN to place the cursor on the Accept Mode: YES line.
7. Press ENTER to confirm the mode change.
  - The new mode selected is shown with its settings. It is applied at the beginning of the next exhalation phase if it occurs during inspiration or immediately if it occurs during exhalation.

It is not mandatory to confirm mode changes during ventilation (see steps 6 and 7, above). The settings of the next mode (shown as INACTIVE on the screen) can be “prepared” while ventilation is in progress in the current mode (shown as ACTIVE on the screen). The modifications will be saved for this next mode, whether or not it is used immediately afterwards.

When setting the parameters of the currently inactive mode, the monitoring data for the mode in progress are shown in the window to the right of the menu and also in the central (Current) column of the table on the Alarm menu screen.

When changing the value of a parameter in the inactive mode, the monitoring data displayed in the window on the right side of the screen are temporarily hidden by the display of the value currently being changed. This is shown in the following figure, as the I Sens setting is adjusted in the inactive V A/C mode.

**Figure 7-29.** Changing Ventilation Modes During Ventilation (4)



If an alarm is triggered during the setting of an inactive mode, its message is shown in the alarm message area.

When the menu of an inactive mode is shown and no changes are made by the user on the keyboard within 14 seconds, the active ventilation mode in use reappears on the screen and the Accept Mode: YES line disappears.

The menu of the active mode can also be recalled without waiting for this delay by directly restoring the name of the mode on the general information line.

The ventilation parameters of the inactive mode and the current mode remain in memory until some or all of the parameters are modified again; this is true even after the machine is stopped.

## 7.5 Setting Ventilation Parameters

Ventilation parameters can be changed as long as the Locking key is not activated (refer to [Unlocking the Control Panel](#) on page 7-35).



### **WARNING:**

**In adult or pediatric use ensure that the adjusted tidal volume is compatible with the needs of the patient.**

Ventilation is not interrupted by the adjustment of a value. It continues according to previous settings. The new settings are applied **only** after they are confirmed and synchronized in the next breath cycle, except for the I Sens setting, which is applied immediately.

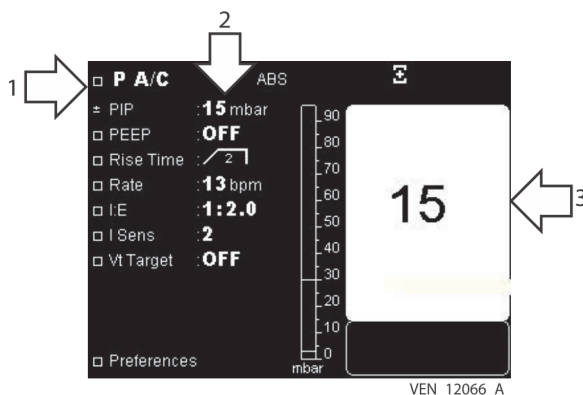


**To modify a ventilation parameter:**



1. Place the cursor on the line of the parameter to be modified using the UP or DOWN key.
2. Validate your intention to modify the parameters using the ENTER button. Refer to *Figure 7-30*.
  - The cursor changes to a plus-minus symbol. (Figure 7-30, item 1)
  - The parameter value flashes (Figure 7-30, item 2)
  - A zoom of the parameter value is shown in the right-side of the window (Figure 7-30, item 3)

**Figure 7-30.** Modifying a Ventilation Parameter



3. Press UP or DOWN to select the value desired for the parameter (continuing to press on these keys speeds up the progression of values shown).
  4. Press ENTER to confirm the selected value.
    - The new parameter value is shown continuously
    - The zoom disappears
    - The cursor returns to normal
- If a parameter change is not confirmed by pressing ENTER before 7 seconds elapse, the ventilator resets the parameter to its previous value.

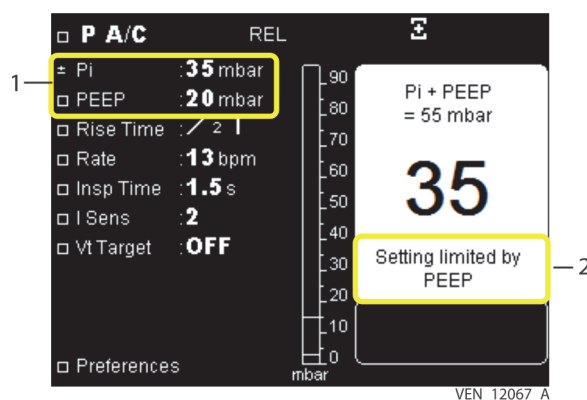
**7.5.1 Links Between Ventilation Parameters**

The adjustment ranges of certain parameters are limited in order to remain compatible with the levels of other previously set parameters. For additional information on the interdependence between ventilation parameters, refer to *Chapter 3, Operating Parameters*.

The message “Setting limited by...” is shown and identifies the parameter (or parameters) that is blocking the setting.

Figure 7-31, item 1, shows that P Support cannot be set above 35 when PEEP is set to 20 and relative pressure is set to YES; this value is limited by PEEP because their sum cannot exceed 55 mbar.

Figure 7-31. Setting Links Between Ventilation Parameters



Two possibilities exist in this case:

- Allow the PEEP setting to remain at 20, but the P Support cannot be increased.
- Reduce PEEP so that the P Support setting can be set higher than 35 to ensure that their sum is no greater than 55.

## 7.5.2 Links Between Ventilation and Alarm Parameters

Setting a ventilation parameter takes priority over an alarm threshold setting and leads to automatic readjustment of the alarm setting threshold so that the interdependence between the two remains unchanged.



Once the ventilator is in service at the patient's home, you should use the Locking key to block access to changing any settings (see [Locking the Control Panel](#) on page 7-35).

## 7.6 Setting Alarm Parameters

Alarm parameters can be changed from the Alarm menu, if the Locking key is not enabled (refer to [Locking the Control Panel](#) on page 7-35 and [Unlocking the Control Panel](#) on page 7-35).



### WARNING:

**Adjustable alarms should not be systematically canceled; instead, they should be adjusted according to the needs and condition of the patient.**



### Note:

Default alarm setting preferences should be entered prior to using the ventilator.

### To modify an alarm parameter:

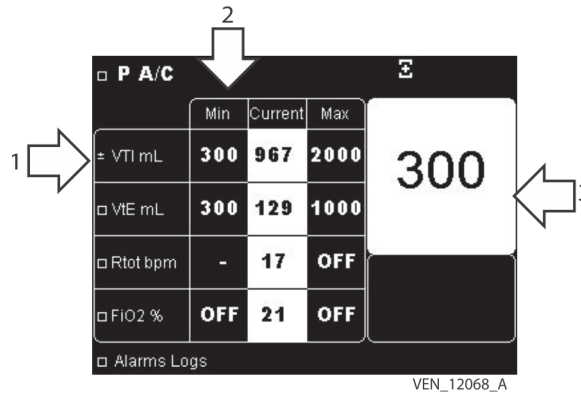
1. Ensure that the Alarm menu is shown, with a list of alarm parameters and columns for the minimum, current, and maximum alarm parameter values (Figure 7-32).



2. Put the cursor next to the alarm parameter to be modified using the UP or DOWN key.

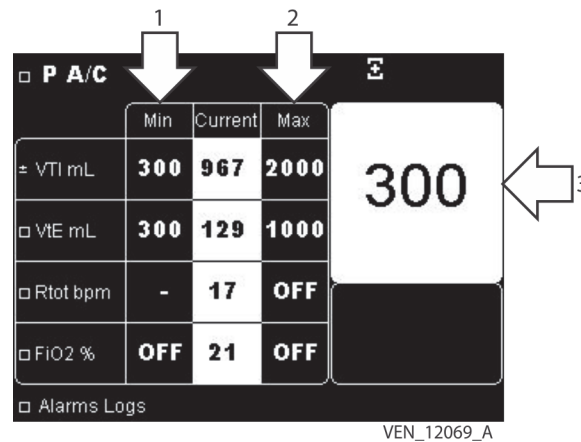
3. Confirm your intention to modify the parameters using the ENTER key.
  - The cursor changes to a plus-minus symbol (Figure 7-32, item 1).
  - The parameter in the Min column flashes (Figure 7-32, item 2).
  - A zoom of the Min parameter is shown on the right side of the screen (Figure 7-32, item 3).

**Figure 7-32.** Modifying Alarm Parameters—Min Value



4. Press UP or DOWN to modify the value of the parameter.
5. Press ENTER to confirm the value selected.
  - The new value for the Min column is continuously displayed (Figure 7-33, item 1).
  - The value of the Max column flashes (Figure 7-33, item 2).
  - A zoom of the Max parameter value is shown on the right side of the window (Figure 7-33, item 3).

**Figure 7-33.** Modifying Alarm Parameters—Max Value



6. Press UP or DOWN to modify the value of the parameter.
7. Press ENTER to confirm the value selected.
  - The new value is continuously shown.



- The zoom disappears.
- The cursor returns to normal.



An alarm is set to OFF (the alarm will not be triggered) when its maximum setting limit (for the Max value) or its minimum setting limit (for the Min value) is reached by successively or continuously pressing UP or DOWN, respectively.



If a parameter change is not confirmed by pressing ENTER before 7 seconds elapse, the ventilator resets the parameter to its previous value.

### 7.6.1 Blocking an Alarm Threshold Linked to a Ventilation Parameter

Setting a ventilation parameter takes priority over an alarm threshold setting. Therefore, if a ventilation parameter is modified when linked to an alarm threshold, the alarm setting threshold is automatically adjusted so that the interdependences linking them are always maintained.

However, if the alarm setting threshold is modified, it cannot be changed beyond the limit of the interdependence with the ventilation parameter to which it is linked. When the alarm setting limit is reached, the message “Setting limited by...” indicates the name of the linked ventilation parameter(s) that are limiting the parameter’s setting value.

Four possibilities exist in this case:

- The alarm parameter remains set to OFF.
- The alarm parameter setting is changed in relation to the value required at the start and the limits on the ventilation parameter (parameters) remain unchanged.
- The setting of the ventilation parameter (or parameters) is changed to enable the alarm threshold to be set to the required value.
- The alarm parameter is not set to OFF but the ventilation parameter change has no impact on the alarm setting.



#### **WARNING:**

**The level of inspiratory resistance of the circuit and accessories (bacteria filter, humidifier) must be as low as possible. Settings—particularly the Patient Disconnection alarm, maximum inspired volume (Max VTI), and minimum inspired volume (Min VTI) settings—must be periodically adjusted according to changes in the patient circuit resistance—especially when filters are replaced.**



#### **WARNING:**

**Adjustable alarms should not be systematically canceled; instead, they should be adjusted according to the needs and condition of the patient.**

## 7.7 USB Menu Parameters

The USB menu is accessible even if the Locking key has been enabled (refer to *Locking the Control Panel* on page 7-35 and section *Unlocking the Control Panel* on page 7-35).

The USB menu is automatically shown when the USB memory device is connected to the ventilator, when ventilation is either on or off.

Only one USB memory device may be connected at any time; otherwise, an error message will be shown. The USB menu is not accessible from the Setup menu or Maintenance menu.


To access patient data via a PC, the Puritan Bennett™ Respiratory Insight software package is available for clinicians. Contact Covidien or your product representative for further information.

### 7.7.1 USB Memory Device Specifications

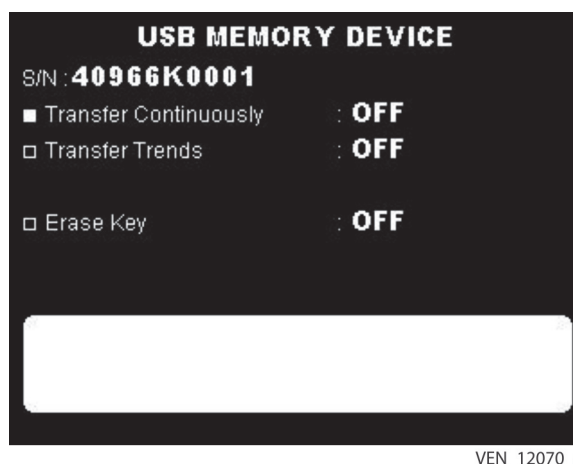
**Table 7-2.** USB Memory Device Specifications

Characteristics	Supported formats
USB compatibility	USB flash memory USB 2.0 or USB 1.1, 32 bit format
Number of files	Maximum 999 (sector size: 512-2048 bytes)
USB size	128 MB to 4GB (to guarantee accuracy of transfer time, at least 10% of the USB memory device capacity must be free)

### 7.7.2 USB Memory Device Menu

-  To access the USB Memory Device menu when a USB memory device is connected, press the MENU key several times, until the menu appears.

**Figure 7-34.** Selecting the USB Menu



VEN\_12070\_A

-  In case of high priority alarm activation the ventilator will automatically show the alarm page. To return to the USB Memory Device menu, press the MENU key.

The adjustable parameters in this menu include the following:

- Transfer Continuously
- Transfer Trends
- Erase Key

### Transfer Continuously

Up to 48 hours worth of data can be transferred from a ventilator to a USB memory device.

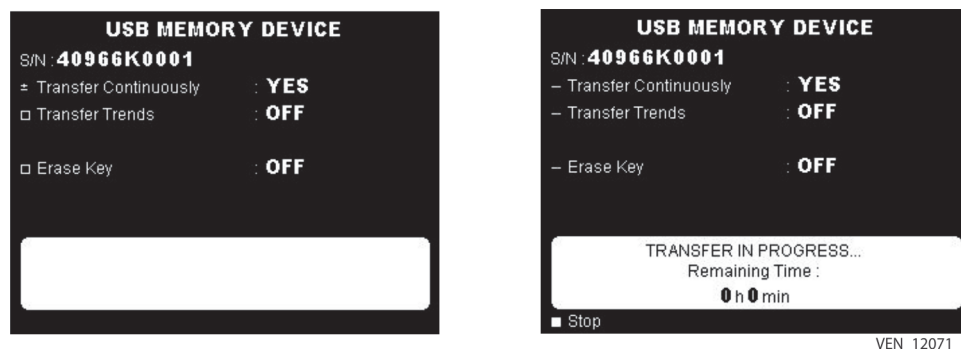
To record continuously, the USB memory device must be permanently connected to the ventilator while ventilation is active.

The following data will be recorded to the USB memory device:

- Monitoring: Pressure, inspired flow, exhaled flow and leak waveforms
- Trends: Leaks, VTI, VTE, Rate, I:E, M. Vol, PIP, and PEEP measurements

The data can be accessed by a doctor or service provider using the Puritan Bennett™ Respiratory Insight software package.

Figure 7-35. Selecting Transfer Continuously



#### To transfer continuous data from a ventilator to a USB memory device:

1. Use the UP or DOWN arrow keys to place the cursor at the Transfer Continuously position.
2. Press ENTER.
  - The cursor changes to the plus/minus symbol.
  - The parameter selected to be modified flashes.
3. Press UP or DOWN to change the selected parameter's value.
4. Press ENTER to confirm the new parameter setting.
  - The new parameter setting is shown continuously.
  - The cursor is placed at the STOP position.

- 5. To manually stop continuous transfer, press ENTER.
- If a parameter change is not confirmed by pressing ENTER before 7 seconds elapse, the ventilator resets the parameter to its previous value.



**Note:**  
All ventilator menus remain accessible during transfer time.



**Note:**  
The message “TRANSFER IN PROGRESS... REMAINING TIME” is shown during the transfer time.



**Note:**  
Other functions of the USB memory device are not available during continuous recording.



**Note:**  
If the memory capacity on the USB memory device is insufficient the message “TRANSFER NOT ALLOWED - USB CAPACITY INSUFFICIENT” is shown and data transfer is not allowed. Delete the data on the USB memory device before restarting data transfer. See *Erase Data from the USB Memory Device* on page 7-34.)



**Note:**  
In case of USB memory device disconnection or transfer error, the message “TRANSFER ERROR - USB DISCONNECTION” or “TRANSFER ERROR - TECHNICAL PROBLEM” is shown. In this case, restart the transfer process. If the problem persists, contact your technical service representative.

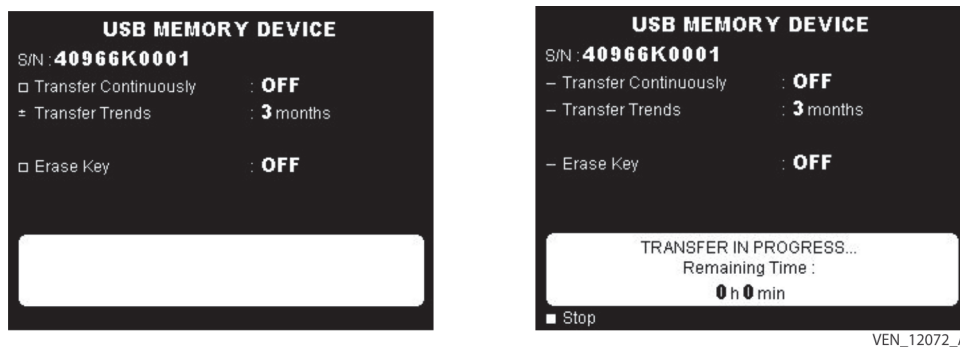
### Transfer Trends

Up to 1 year’s worth of trend data can be transferred from a ventilator to a USB memory device.

Ventilation trends such as leaks, VTI, VTE, Rate, I:E, M. Vol, PIP, and PEEP measurements can be transferred from the ventilator to a USB memory device.

The data can be accessed by a doctor or service provider using the Puritan Bennett™ Respiratory Insight software package.

**Figure 7-36.** Selecting Transfer Trends



**To transfer trend data from a ventilator to a USB memory device:**

1. Use the UP or DOWN arrow keys to place the cursor at the Transfer Trends position.



2. Press ENTER.

- The cursor changes to the plus/minus symbol.
- The parameter selected to be modified flashes.



3. Press UP or DOWN to change the selected parameter's value.



4. Press ENTER to confirm the new parameter setting.

- The new parameter setting is shown continuously.
- The cursor is placed at the STOP position.



5. To manually stop trend transfer, press ENTER.



If a parameter change is not confirmed by pressing ENTER before 7 seconds elapse, the ventilator resets the parameter to its previous value.

**Table 7-3.** Ventilator to USB Device Data Transfer Times

Amount of trends data (in months)	Transfer time from ventilator to USB memory device
3 months	Approximately 2 minutes
6 months	Approximately 4 minutes
9 months	Approximately 6 minutes
12 months	Approximately 8 minutes

**Note:**

The message "TRANSFER IN PROGRESS... REMAINING TIME" is shown during the transfer time.

**Note:**

Other USB memory device functions are available during transfer of trends.

**Note:**

If the memory capacity on the USB memory device is insufficient the message "TRANSFER NOT ALLOWED - USB CAPACITY INSUFFICIENT" is shown and data transfer is not allowed. Delete the data on the USB memory device before restarting data transfer. See [Erase Data from the USB Memory Device](#) on page 7-34.

**Note:**

In case of USB memory device disconnection or transfer error, the message "TRANSFER ERROR - USB DISCONNECTION" or "TRANSFER ERROR - TECHNICAL PROBLEM" is shown. In this case, restart the transfer process. If the problem persists, contact your technical service representative.

## Erase Data from the USB Memory Device



### To erase data from the USB memory device:

1. Use the UP or DOWN arrow keys to place the cursor at the Erase key position.



2. Press ENTER.



- The cursor changes to the plus/minus symbol.
- The parameter selected to be modified flashes.



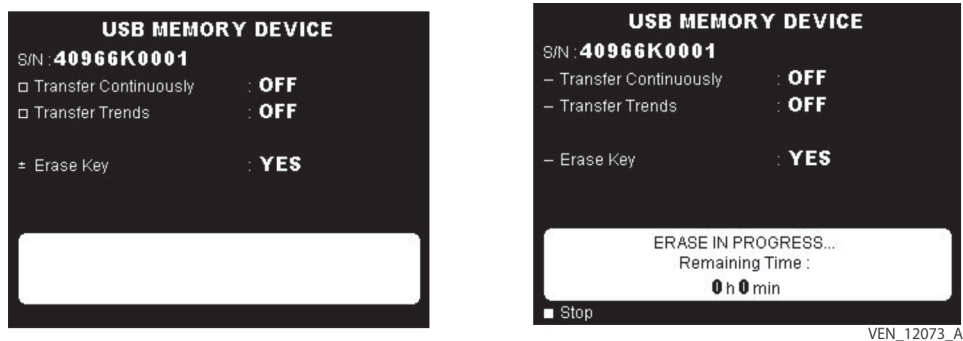
3. Press UP or DOWN to change the selected parameter's value.



4. Press ENTER to confirm the new parameter setting.

- The new parameter setting is shown continuously.
- The cursor is placed at the STOP position.

**Figure 7-37.** Erasing Data from the USB Memory Device



### Caution:

Deletion erases ALL files present on the USB memory device.



### Note:

The message "ERASE IN PROGRESS... REMAINING TIME" is shown during the deletion time.



### Note:

The deletion time of a full USB memory device is less than 1 minute.



### Note:

Other USB memory device functions are not available during deletion.



### Note:

Once deletion of data on the USB memory device has been started, it cannot be paused, stopped, or canceled.



**Note:**

All ventilator menus remain accessible during deletion.



**Note:**

In case of USB memory device disconnection or deletion error, the message “TRANSFER ERROR - USB DISCONNECTION” or “ERASE ERROR - TECHNICAL PROBLEM” is shown. In this case, restart the erase process. If the problem persists, contact your technical service representative.

## 7.8 Locking the Control Panel

When the machine is in service at a patient’s home, it is strongly recommended that you prevent accidental or unauthorized ventilator adjustments from occurring by enabling the Locking key.



The Locking key is a software function that prohibits access to the ventilation and alarm parameter settings and changes to the ventilation mode.



To enable the Locking key, simultaneously press the UP key and the DOWN key for at least 6 seconds.

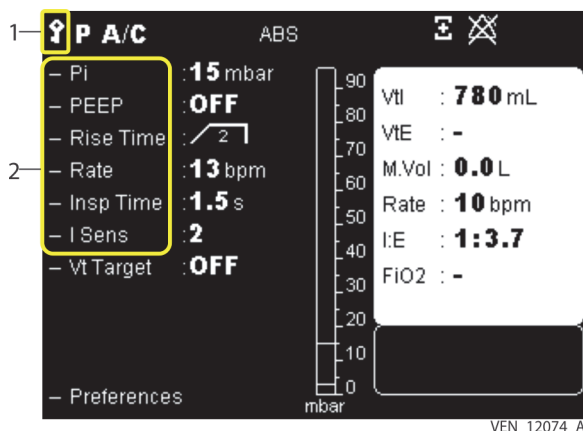


- The Locking key symbol (Figure 7-38, item 1) appears in the top left corner of the screen.
- Functions that are no longer accessible are preceded by a dash (Figure 7-38, item 2).



- Functions that remain accessible keep their initial line access symbol.

Figure 7-38. Installing the Locking Key



## 7.9 Unlocking the Control Panel



To disable the Locking key, simultaneously press the UP key and the DOWN key for at least 6 seconds.



- The Locking key symbol disappears.



- The initial line access symbol is shown in front of each line.

## 7.10 Starting Ventilation

Before starting ventilation, see Appendix E, *Operational Verification Checklist*, and set the parameter values in the Preferences menu (see section 7.3, *Preferences Menu Parameters*).



**WARNING:**

Verify the functionality of the alarms before connecting the patient to the ventilator.



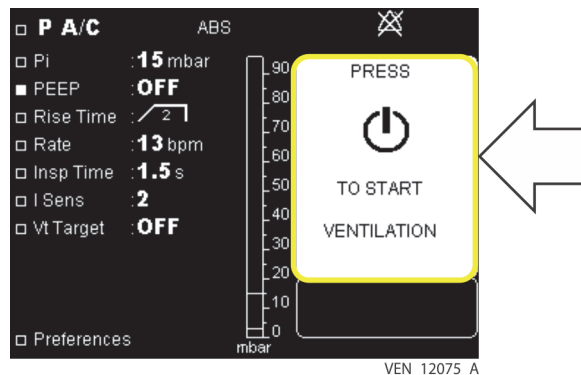
**WARNING:**

Before starting ventilation, ensure that the device is properly assembled and that the air inlet, cooling vents, and alarm sound diffusion holes are not obstructed. Ensure also that the patient circuit is of the proper configuration (double or single limb), properly connected to the ventilator, and that the circuit hoses are neither damaged nor compressed and contain no obstructions or foreign bodies.



When the ventilator is in standby (the ventilator is on, but ventilation has not started), a message that prompts the ventilator operator to press VENTILATION ON/OFF to start ventilation is shown in the right-hand window of the Ventilation and Alarm menus (Figure 7-39).

Figure 7-39. Prompt to Start Ventilation

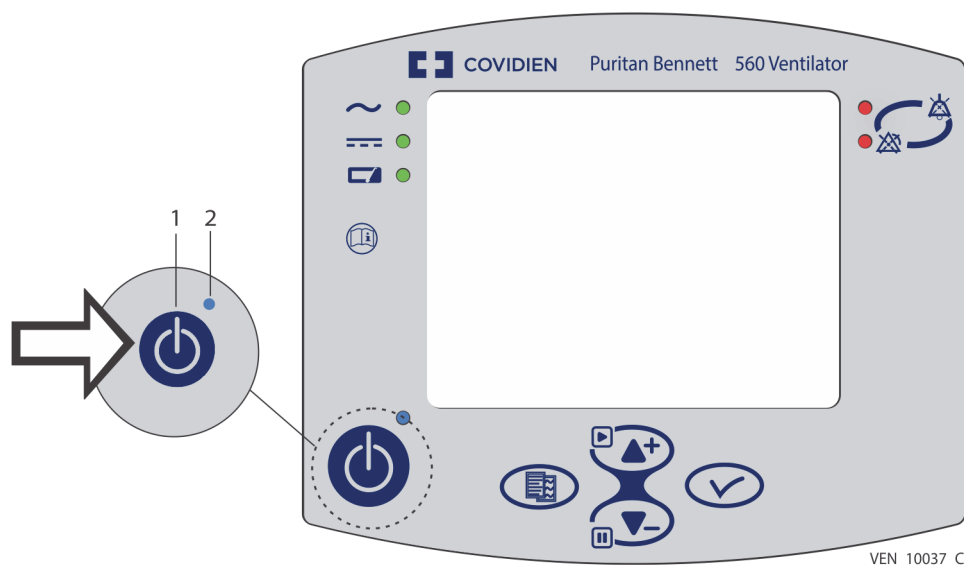


To start ventilation, press and release VENTILATION ON/OFF (Figure 7-40, item 1).

- The blue light indicator, at the upper right of the VENTILATION ON/OFF key (Figure 7-40, item 2), turns off.
- A beep sounds.
- Ventilation starts.
- The values of the monitored parameters are shown in the right-hand window.



Figure 7-40. Starting Ventilation



## 7.11 Stopping Ventilation



### WARNING:

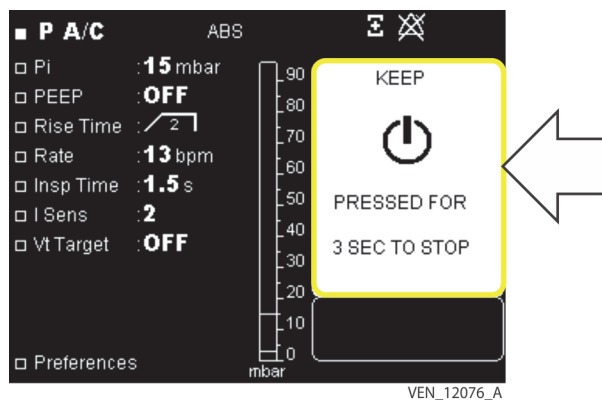
Do not allow a patient to remain connected to the ventilator when ventilation is stopped, because a substantial quantity of expiratory gas, primarily carbon dioxide, may be inhaled by the patient. In some circumstances, inhaling carbon dioxide may lead to under-ventilation, suffocation, and serious injury or death.

### To stop the ventilator:



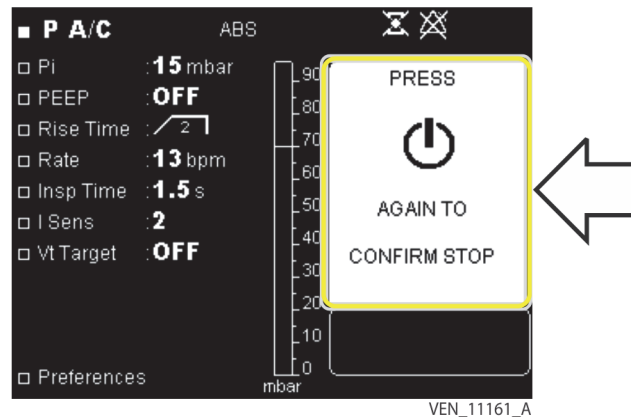
1. Press and hold the VENTILATION ON/OFF button (Figure 7-40, item 1) for 3 seconds. The following occurs:
  - A message prompting the user to keep the button pressed appears on the monitoring window, as shown in Figure 7-41.

Figure 7-41. Stopping Ventilation (1)




- After 3 seconds, a new message appears that directs the user to press the button again to confirm ventilation stop as shown in *Figure 7-42*.

**Figure 7-42.** Stopping Ventilation (2)



- A double beep sounds.
2. Release the VENTILATION ON/OFF button.
- A double beep sounds.
3. Press the VENTILATION ON/OFF button again within 5 seconds to confirm stop, otherwise ventilation will continue.
    - Ventilation stops.
    - The blue LED located to the upper-right of the VENTILATION ON/OFF button (Figure 7-40, item 2) illuminates to indicate ventilation is on standby.
    - A prompt for a new start of ventilation is shown (see Figure 7-39 on page 7-36).

## 7.12 Turning Off the Ventilator

**WARNING:** When the ventilator is switched back on after it was switched off while ventilation was in progress, it will immediately begin ventilating—without the user first having to press the VENTILATION ON/OFF  key.

**WARNING:** Handle the ventilator with care after use, particularly when ambient temperatures are high. Some ventilator surfaces may be very hot, even if safety specifications are not exceeded.

Set the I/O (power) switch to the O position to turn off the ventilator.

- The blue LED to the right of the VENTILATION ON/OFF button turns off.
- The ventilator screen switches off.

**Note:**

When the ventilator is completely stopped, but is still connected to the AC power source (the green AC POWER indicator is illuminated), the internal battery continues charging.

**Note:**

A continuous alarm condition will be activated if the ventilator power switch is turned off while ventilation is in progress. When the power switch is turned back on again, the ventilation will resume without having to press the VENTILATION ON/OFF button.

Page Left Intentionally Blank

## 8 Internal Battery



**WARNING:**

Even though the Puritan Bennett™ 560 ventilator meets current safety standards, the internal Lithium-ion battery of the device exceeds the 100Wh threshold and is therefore considered to be Dangerous Goods (DG) Class 9 – Miscellaneous, when transported in commerce. As such, the Puritan Bennett™ 560 ventilator and/or the associated Lithium-ion battery are subject to strict transport conditions under the Dangerous Goods Regulation for air transport (IATA: International Air Transport Association), International Maritime Dangerous Goods code for sea and the European Agreement concerning the International Carriage of Dangerous Goods by Road (ADR) for Europe. Private individuals who transport the device are excluded from these regulations although for air transport some requirements apply. For air transport; the Puritan Bennett™ 560 ventilator is permitted as checked-in or carry-on baggage. Two spare batteries per person may be taken on board as carry-on luggage only, with the prior approval of the airline. This classification and regulatory requirements may vary depending upon the country and mode of transport. Therefore it is recommended that users verify with the carrier / airline as to which measures to take before the voyage.



**WARNING:**

Ensure that the ventilator's internal battery is fully charged before connecting the ventilator to an external DC power source. Powering the ventilator using an external 12–30 VDC power source (via the DC power cable) does not enable charging of its internal battery.



**WARNING:**

The maximum recommended shelf life of the internal battery is 2 years. Do not use a battery that has been stored for 2 years prior to its first use.



**WARNING:**

Periodic recharging is important to help maximize useful life of the battery. Do not store the internal battery for extended periods, without recharging, as this may reduce the maximum life.



**WARNING:**

Do not attempt to replace the battery yourself. Replacement of lithium batteries or fuel cells by inadequately trained personnel could result in a fire hazard. Replacement must be completed by qualified service personnel only.

## 8.1 Battery Capacity

The reserve capacity offered by the internal battery depends on the level of ventilation parameters, the environmental conditions (primarily in terms of temperature) and the physiological characteristics of the patient.

With a fully charged battery at a normal room temperature of 25°C ( $\pm 5^\circ\text{C}$ ), the ventilator can be expected to operate on internal battery power for the average durations shown in [Table 8-1](#).

Checking the battery charge level requires that the ventilator be running on battery power at the time of the battery check. To check the battery charge level, temporarily disconnect the ventilator from AC power (while in standby mode or while providing ventilation) and read the percent charge level shown adjacent to the battery icon at the top of the ventilator's display screen.

**Table 8-1.** Internal Battery Reserve Capacity

Displayed values	Average operating time on internal battery power <sup>1</sup>
Vt = 200 ml ( $\pm 5$ ml) PIP = 10 mbar ( $\pm 2$ mbar) Rate = 20 bpm	11 hours (-10%)
Vt = 300 ml ( $\pm 5$ ml) PIP = 20 mbar ( $\pm 2$ mbar) Rate = 15 bpm	9 hours (-10%)
Vt = 500 ml ( $\pm 5$ ml) PIP = 30 mbar ( $\pm 2$ mbar) Rate = 15 bpm	6.5 hours (-10%)
Vt = 750 ml ( $\pm 5$ ml) PIP = 45 mbar ( $\pm 2$ mbar) Rate = 20 bpm (maximum ventilation parameters)	4.5 hours (-10%)

1. Average durations shown are with a fully charged battery having less than 50 charge/recharge cycles.

The operational time of the ventilator when powered from a fully charged power source<sup>1</sup> is 6.5 hours (-10%) under the following conditions:

- Delivered Volume = 800 ml ( $\pm 5$  ml)
- Rate = 20 bpm
- I:E = 1:2
- Backlight = OFF
- Resistance = 5 hPa/lps
- Compliance = 50 ml/hPa

## 8.2 Battery Operation



### WARNING:

Before using the ventilator's internal battery, ensure that the battery is fully charged and that the charge holds. Back up ventilators or those in storage should be connected to an AC power source to protect the integrity of the battery.



### Note:

Buzzer and battery alarms may occur when the unit is first powered on after the internal battery has been completely drained. Connect to an AC power source and recycle power.

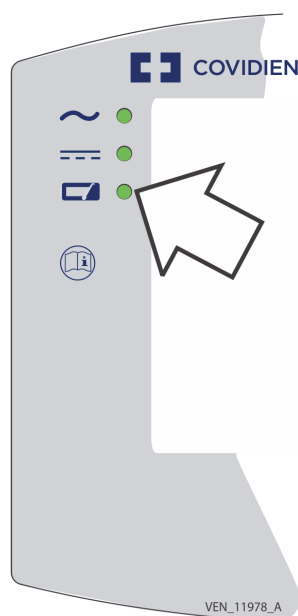


### Note:

In the event of AC power interruption or disconnection of the external AC or DC power supply, the ventilator automatically switches to its internal battery and the following events occur:

- The internal battery indicator at the top left of the ventilator's front panel is continuously lit. See Figure 8-1.

Figure 8-1. Internal Battery Indicator



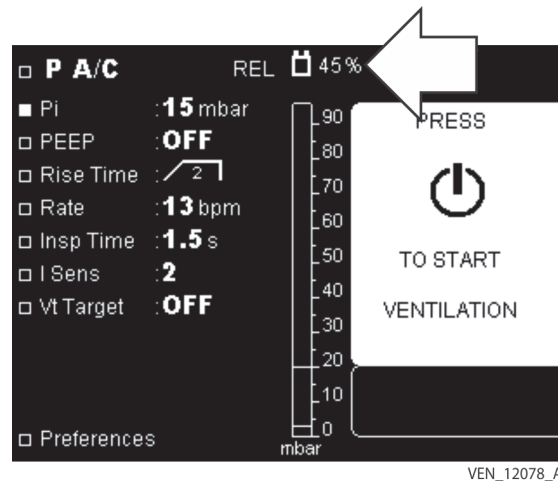
- A loss of external supply alarm is activated.



- The Battery symbol is shown at the top of the screen, on the general information line.
- Internal battery reserve capacity is shown to the right of the Battery symbol.

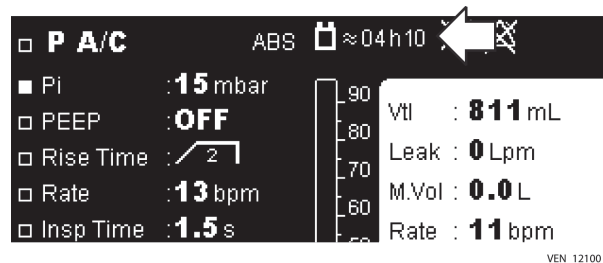
If ventilation is stopped, the internal battery reserve capacity is shown as a percentage of battery charge. See [Figure 8-2](#).

Figure 8-2. Battery Reserve Capacity as a Percentage



If the ventilator is running, the internal battery reserve is momentarily shown as a percentage. Then, after the ventilator calculates the battery time remaining (which takes about 2 minutes, depending on the power consumption of the ventilator), the internal battery reserve is then shown in hours and minutes (rounded to the nearest 10 minutes). See [Figure 8-3](#).

Figure 8-3. Battery Reserve Capacity in Hours and Minutes



The Low Battery and Empty Battery alarms (see [Chapter 5, Alarms and Troubleshooting](#)) are triggered when the internal battery reserve is reduced.

**WARNING:**

**Due to the internal battery's limited reserve capacity, the ventilator should only be operated on the internal battery when no other power source is available. Ensure that the internal battery never becomes fully discharged.**

**WARNING:**

**When the Low Battery alarm is triggered, immediately connect the ventilator to an AC power supply to maintain ventilation and recharge the internal battery.**

From the time that an Empty Battery alarm is activated, if no external supply is connected to the ventilator, other alarms may be triggered due to insufficient supply voltage.

In the final discharge phase, the Empty Battery alarm will become continuous, and ventilation may be interrupted at any time during this phase.



**Note:**

The Empty Battery alarm symbol may disappear shortly before the ventilator completely stops, but it always triggers a final, continuous alarm.

## 8.3 Testing the Battery

The ventilator continuously and automatically checks the state of the internal battery, even when the battery is not used as the main source of energy. The Battery Fault 1 alarm is activated whenever a problem is detected in the battery or the charger.

However, on a monthly basis you should disconnect the ventilator from the external power supply to check the integrity of the connections linking the internal battery to other ventilator components.

## 8.4 Recharging the Battery

In the event that the battery charge level is considered insufficient, as per the reserve capacity display, recharge of the internal battery is necessary. In general, it is recommended that the ventilator be allowed to charge when the battery drops below 80%, and that the ventilator be recharged systematically after storage and before using it again.

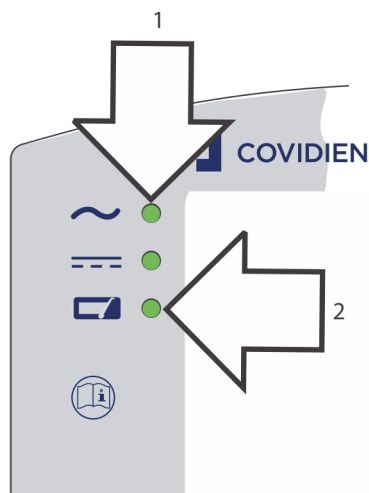
**Note:**

To avoid cycling and extend battery life while connected to an AC power source, the battery will not begin charging until it has dropped below an 85%-90% charge.

To charge the internal battery, connect the ventilator to the AC power source.

- The AC power indicator illuminates (Figure 8-4, item 1).
- The internal battery indicator flashes (Figure 8-4, item 2).

**Figure 8-4.** Power Indicators When Charging the Battery



When the battery charge is complete, the internal battery indicator turns off.

**WARNING:**

**Even if the internal battery indicator is off, charge of the battery may sometimes be incomplete regardless of charge time when the ambient temperature is above 40°C (104°F). This is due to the characteristics of the battery's internal heat safety device.**

Although it is not necessary to start the ventilator to charge the battery, charging the battery during operation will increase the time required to fully charge the internal battery.

When recharging a depleted internal battery, it may be necessary to leave the ventilator on charge for up to 6 hours if the ventilator is on standby and about 13 hours if ventilation is operating.

**WARNING:**

**Ensure that the ventilator's internal battery is fully charged before connecting the ventilator to an external DC power source. Powering the ventilator using an external 12–30 VDC power source (via the DC power cable) does not enable charging of its internal battery.**

## 8.5 Storage

If the ventilator is to be stored for an extended period of time, it is not necessary to remove the battery. However, the ventilator should be stored in cool, dry, well-ventilated environment, as follows:

- Temperature: approximately 21°C (70°F)
- Humidity: less than 80% RH

**Note:**

When the device is in storage it should be recharged monthly to maximize battery life.

**Note:**

If the battery is stored for more than 1 month at a temperature greater than 21°C (70°F), or for more than 1 or 2 weeks at a temperature greater than 45°C (113°F), the reserve capacity of the battery may be affected. It will then be necessary to recharge the battery before using it again.

**Note:**

If the ventilator has been in storage for longer than 30 days connect it to an AC power source, turn on the unit by the I/O (power) switch at the rear of the ventilator, and let it charge for 15 minutes prior to starting ventilation.

**Note:**

Fully charge the internal battery prior to disconnecting from AC power source ("mains").

**Note:**

The battery should not be stored for more than 2 years, whatever the conditions.

# 9 Cleaning



**WARNING:**

A patient treated by mechanical ventilation is highly vulnerable to the risks of infection. Dirty or contaminated equipment is a potential source of infection. Clean the ventilator and its accessories regularly and systematically before and after each use and following any maintenance procedure to reduce the risks of infection. The use of a bacterial filter at the ventilator's outlet (TO PATIENT) port—or both ports if a double-limb circuit is used—is highly recommended.



**WARNING:**

To reduce the risk of infection, wash your hands thoroughly before and after handling the ventilator or its accessories.

## 9.1 Cleaning the Ventilator

Clean all external panels and surfaces before and after each patient use and as often as necessary to keep the ventilator clean. You should clean the ventilator weekly, whenever it is soiled or dirty, before any maintenance operation, and before storing the ventilator.



**WARNING:**

Use all cleaning solutions and products with caution. Read and follow the instructions associated with the cleaning solutions you use to clean your ventilator. Use only those solutions listed in [Table 9-1](#).



**WARNING:**

The ventilator should never be immersed in any liquid, and any liquid on the surface of the device should be wiped away immediately.



**WARNING:**

To avoid damage to the ventilator, in particular the batteries or electrical components, fluids must not be allowed to enter the device, particularly through the air inlet filter or the cooling apertures located in the side, rear, and bottom panels of the ventilator.

**To clean the surface of the ventilator:**

1. Dip a clean, soft cloth into a mixture of mild soap and water, or other approved cleaning solution. For a list of approved cleaning solutions, see [Table 9-1](#).

**Table 9-1.** Approved Cleaning Solutions for Exterior Ventilator Surfaces

Description
Mild dishwashing detergent
70% isopropyl alcohol (rubbing alcohol)
10% chlorine bleach (90% tap water)
Glutaraldehyde
Hospital disinfectant cleaners
Hydrogen peroxide
15% ammonia (85% tap water)
Ammonia-based household cleaners
Household cleaners

2. Squeeze the cloth thoroughly to remove excess liquid.
3. Lightly wipe the external casing of the ventilator, taking care not to allow excess moisture to enter any of the openings on the ventilator’s surface. See the warnings in this section.
4. Dry the ventilator surface with a clean, soft, lint-free cloth.

## 9.2 Cleaning the Accessories

Follow the accessory manufacturer’s instructions for cleaning the ventilator’s accessories and components, including the patient circuit.



**WARNING:**

After assembling, cleaning, or reassembling the patient circuit, and on a daily basis, inspect the hoses and other components to ensure that there are no cracks or leaks and that all connections are secure.




**WARNING:**

Never use a liquid cleaner inside the patient circuit, or on any component of a gas pathway. Clean the patient circuit only as specified by the manufacturer's instructions.

## 9.3 Cleaning the Exhalation Block



**WARNING:**

The exhalation block is intended for single use by a single patient . It may periodically be cleaned, but it cannot be disinfected or sterilized. To maintain good measurement quality when used continuously, clean the exhalation block periodically. The exhalation block should be changed every 4 months and cannot be reused with any other patient.

**WARNING:**

Ensure that the exhalation block is completely dried after cleaning and prior to use.

The exhalation block can be removed easily from the device by first removing a captive screw, accessible through the bottom of the device (see *Exhalation Block* on page 6-20).

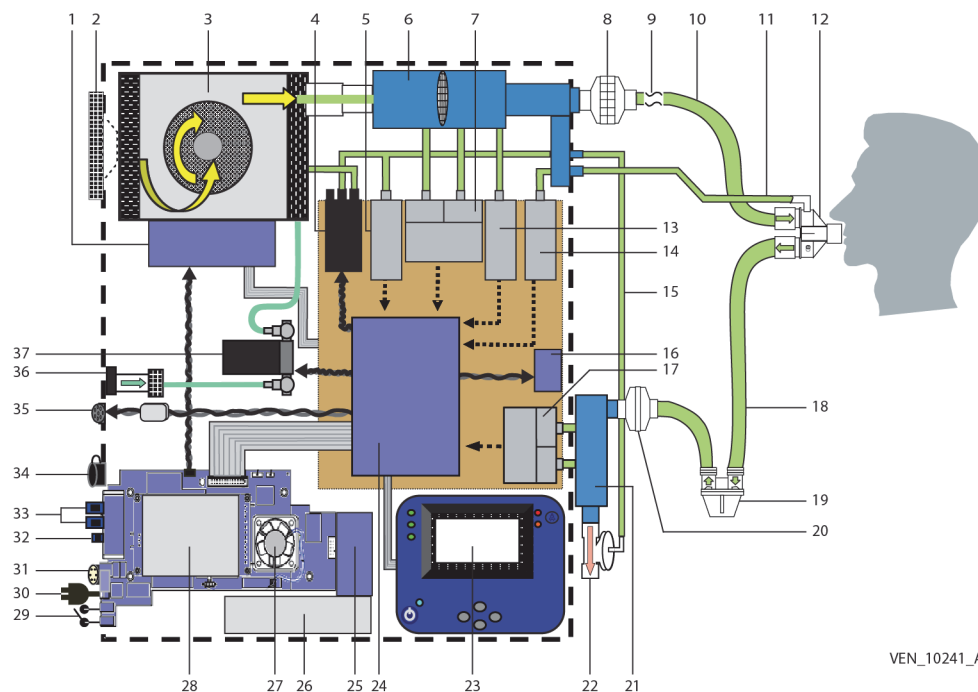
Whenever the exhalation block is removed or after installing a new one, you must calibrate the exhalation flow sensor. See *Calibrating the Exhalation Flow Sensor* on page 10-2.

## 9.4 Pneumatic System

This section describes the components of the pneumatic system.

Figure 9-1 shows a pneumatic block diagram of the Puritan Bennett™ 560 Ventilator, including the patient circuit. The main pneumatic components that can potentially get contaminated during use are the air inlet filter (2); low pressure oxygen inlet /valve (36); oxygen solenoid valve (37); inlet and outlet silencers (not shown); turbine assembly (3); exhalation solenoid valve (4); inspiratory block (6); inspiratory flow sensor (7); proximal pressure sensor (14); inspiratory pressure sensor (13); exhalation valve (internal valve) (22); exhalation block (21); exhalation flow sensor (17); barometric pressure sensor (not shown); patient circuit (9, 10, 11, 12, 18, and 19); and inspiratory and expiratory bacteria filters (8 and 20).

**Figure 9-1.** Puritan Bennett™ 560 Ventilator Pneumatic Diagram



VEN\_10241\_A

1	Turbine control PCBA	20	Exhalation bacteria filter
2	Air inlet filter	21	Exhalation block
3	Turbine	22	Exhalation valve

4	Exhalation solenoid valve	23	Display
5	Exhalation valve pressure sensor	24	CPU PCBA
6	Inspiratory block	25	Battery connection PCBA
7	Inspiratory flow sensor	26	Internal battery
8	Inspiratory bacteria filter	27	Cooling fan
9	Humidifier, nebulizer, or additional water traps (not shown)	28	Power supply (located above power management PCBA)
10	Inspiratory tubing	29	Power switch
11	Proximal pressure tube	30	AC input
12	Patient wye	31	DC input
13	Inspiratory pressure sensor	32	PC port
14	Proximal pressure sensor	33	Type A USB ports (2)
15	Exhalation valve pilot tube	34	SpO <sub>2</sub> port (not used)
16	Buzzer PCBA	35	Nurse call port
17	Exhalation bacteria filter	36	Low pressure O <sub>2</sub> inlet
18	Exhalation tubing	37	O <sub>2</sub> solenoid valve
19	Water trap		

The inspiratory filter protects the ventilator from contamination by the patient (primarily, rebreathed gas). To prevent any risk of cross contamination the use of DAR™ filter (Ref: 351/5856 or equivalent) is recommended to protect the patient outlet port and the exhalation block port.

If the inspiratory or expiratory bacteria filters have not been changed frequently (according to institutional protocol and/or manufacturer recommendation) and have not been installed properly on the inlet and exhaust ports of the ventilator to prevent cross contamination, the entire inspiratory block requires cleaning and disinfection, the expiratory block requires replacement, circuits and filters require replacement, and flow sensor calibration should be considered before new patient use.

# 10 Routine Maintenance

## 10.1 Overview

This chapter lists routine maintenance procedures for the Puritan Bennett™ 560 ventilator.



**WARNING:**

On a **DAILY** basis, inspect the patient circuit to ensure that it shows no signs of damage, is properly connected, and is operating correctly without leakage.



**WARNING:**

Do not attempt to open, repair or otherwise service the ventilator yourself. Doing so might endanger the patient, damage the ventilator, and/or void your warranty. Only personnel authorized and qualified by Covidien should repair, open or service the ventilator.



**WARNING:**

Ensure that the ventilator is powered off and not in use before performing routine maintenance.



**WARNING:**

Do not perform any maintenance activities while the ventilator is in use on a patient.



**WARNING:**

Contact local authorities to determine the proper method to dispose of potentially hazardous parts and accessories.

## 10.2 Expected Service Life

The Puritan Bennett™ 560 ventilator should have an expected service life of 10 years, provided that the preventive maintenance schedule in the Puritan Bennett™ 560 ventilator service manual is followed.

### 10.3 Calibrating the Exhalation Flow Sensor

Each time the exhalation block or circuit is removed and reinstalled or after installing a new exhalation block, the exhalation flow sensor must be recalibrated before using the ventilator. This process is automatic and does not require the use of a measurement device.



**Note:**

Perform calibration with either an adult or pediatric circuit. Use the appropriate Pediatric setting (Yes or No) in the Preferences menu.

**To calibrate the exhalation flow sensor:**

1. Ensure the ventilator is on and in standby mode.
2. Ensure the Locking key is disabled (see *Unlocking the Control Panel* on page 7-35).
3. Obstruct the patient circuit’s open connector. See *Figure 10-1*.

**Figure 10-1.** Blocking the Patient Circuit (single-limb circuit at left; double-limb circuit at right)



4. Press the MENU key to access the alarm settings menu—if this is not the menu currently shown.



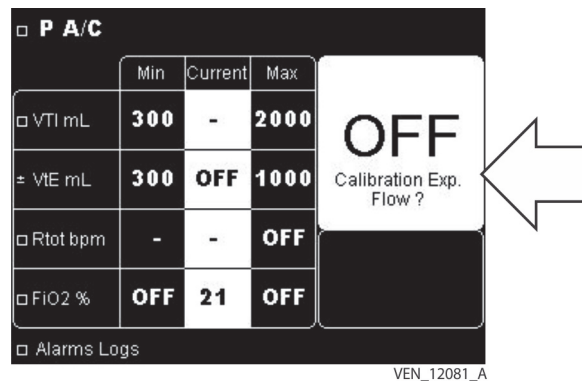
5. Press the UP or DOWN key to place the cursor on the VTE setup line.



6. Press the ENTER key twice to access the Patient column (central column) of the VTE setup line.
  - “OFF” flashes in the central column.
  - “OFF” flashes in the window on the right.
  - The message “Calibration Exp. Flow?” also appears in the window on the right.

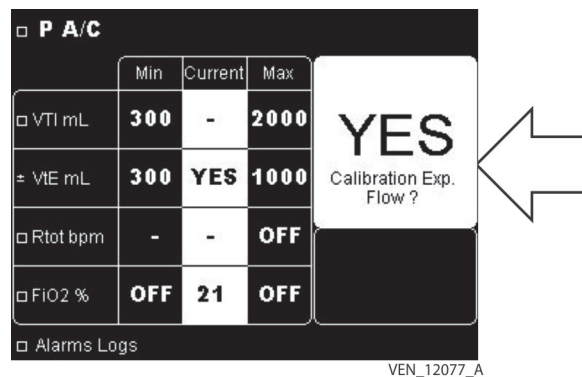


**Figure 10-2.** Calibrating the Exhalation Flow Sensor (1)



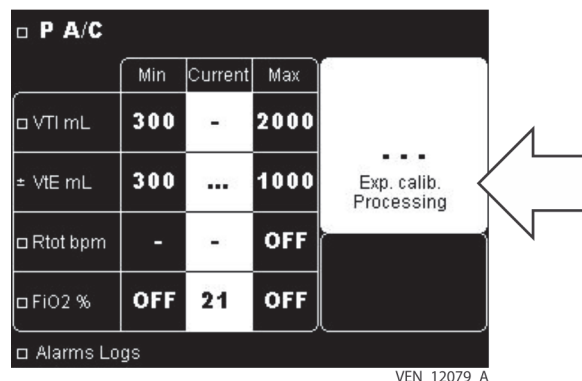
- Press the UP or DOWN key. "YES" is shown instead of "OFF".

**Figure 10-3.** Calibrating the Exhalation Flow Sensor (2)



- Press the ENTER key to start calibration.
  - The message "... Exp. calib. Processing ..." is shown in the window on the right while calibration is in progress.

**Figure 10-4.** Calibrating the Exhalation Flow Sensor (3)



- The ventilator adjusts the speed of the blower to reach the initial calibration point.
- A short beep sounds to confirm the first adjustment.
- The ventilator automatically increases and adjusts the speed of the blower to reach the next calibration point.

- A short beep sounds to confirm the second adjustment.
- This process continues until adjustments are complete for all eight calibration points.



**Note:**

The exhalation flow sensor calibration procedure, once initiated, must run to its conclusion.



**Note:**

No message is shown when the ventilator passes calibration; a message is only shown if the calibration has failed.

In the event of calibration errors, the following events occur:

- The ventilator sounds a long beep at each point that fails calibration.
- An alarm is activated, and the message “CALIBRATION FAIL” is shown.
- The ventilator takes the previously saved value as the default and automatically switches to the next calibration point.

**If a Calibration Fail alarm occurs:**

1. Ensure the exhalation block is properly seated.
2. Ensure an approved circuit is in use (see circuit documentation).
3. Check the integrity of the circuit and all connections.
4. Ensure the correct circuit type is selected in the ventilator preferences.
5. Repeat the calibration procedure keeping a tight seal over the end of the circuit during calibration.

For more information on the Calibration Fail alarm, see section [5.9, Troubleshooting](#).

## 10.4 Calibrating the FiO<sub>2</sub> Sensor

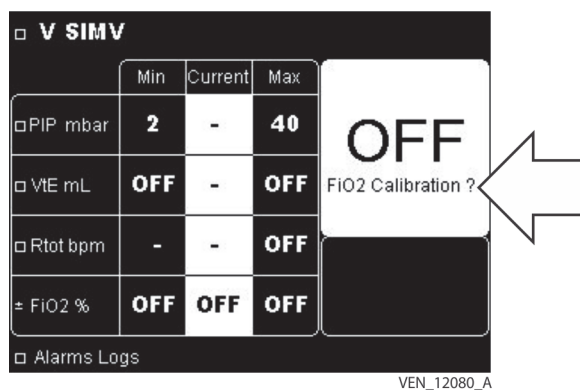
Each time the FiO<sub>2</sub> sensor is removed and reinstalled, and on a weekly basis, the FiO<sub>2</sub> sensor must be recalibrated before using the ventilator. This process does not require the use of a measurement device.

**To calibrate the FiO<sub>2</sub> sensor:**

1. Ensure the ventilator is on and in standby mode.
2. Ensure the Locking key is disabled (see [Unlocking the Control Panel](#) on page 7-35).
3. Connect the FiO<sub>2</sub> sensor to the ventilator (see [Connecting the FiO<sub>2</sub> Sensor](#) on page 6-25).
4. Press the MENU key to access the alarm settings menu—if this is not the menu currently shown.
5. Press the UP or DOWN key to place the cursor on the FiO<sub>2</sub> setup line.



6. Press the ENTER key twice to access the Patient column (central column) of the FiO<sub>2</sub> setup line.
- “OFF” flashes in the central column.
  - “OFF” flashes in the window on the right.
  - The message “FiO<sub>2</sub> Calibration?” also appears in the window on the right.

Figure 10-5. Calibrating the FiO<sub>2</sub> Sensor (1)


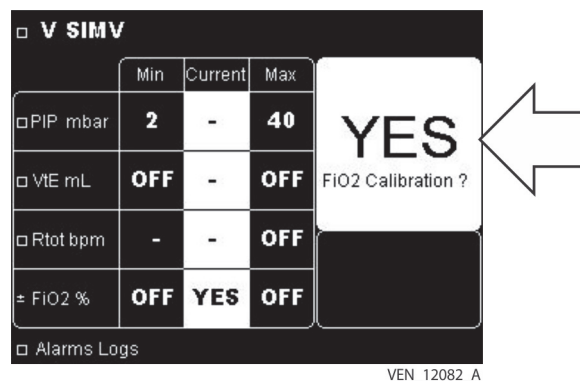
	Min	Current	Max	
□ PIP mbar	2	-	40	OFF FiO <sub>2</sub> Calibration ?
□ VtE mL	OFF	-	OFF	
□ Rtot bpm	-	-	OFF	
± FiO <sub>2</sub> %	OFF	OFF	OFF	

□ Alarms Logs

VEN\_12080\_A



7. Press the UP or DOWN key. “YES” is shown instead of “OFF”.

Figure 10-6. Calibrating the FiO<sub>2</sub> Sensor (2)


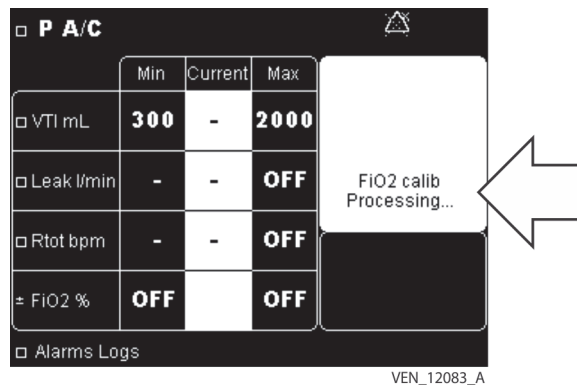
	Min	Current	Max	
□ PIP mbar	2	-	40	YES FiO <sub>2</sub> Calibration ?
□ VtE mL	OFF	-	OFF	
□ Rtot bpm	-	-	OFF	
± FiO <sub>2</sub> %	OFF	YES	OFF	

□ Alarms Logs

VEN\_12082\_A

8. Press the ENTER key to start calibration.
- The message “FiO<sub>2</sub> calib. Processing...” is shown in the window on the right while calibration is in progress.

Figure 10-7. Calibrating the FiO<sub>2</sub> Sensor (3)



- A short beep sounds to confirm that the FiO<sub>2</sub> sensor has been calibrated.

9. Press the ENTER key to exit the FiO<sub>2</sub> setup line.



**Note:**

The FiO<sub>2</sub> sensor calibration procedure, once initiated, must run to its conclusion.

In the event of calibration errors, the following events occur:

- An alarm is activated and the message “FiO<sub>2</sub> CALIBRATION FAIL” is shown.
- The ventilator takes the previously saved value as the default.

For more information on the FiO<sub>2</sub> Calibration Fail alarm, see Chapter 5.9, *Troubleshooting*.

## 10.5 Replacing the Air Inlet Filter



**WARNING:**

Regularly check the cleanliness of the air inlet filter located on the rear of the ventilator. If necessary, replace the filter before the recommended replacement period is over. This is particularly important when the ventilator is installed on a wheelchair, because environmental conditions may cause the filter to become dirty more rapidly.



**WARNING:**

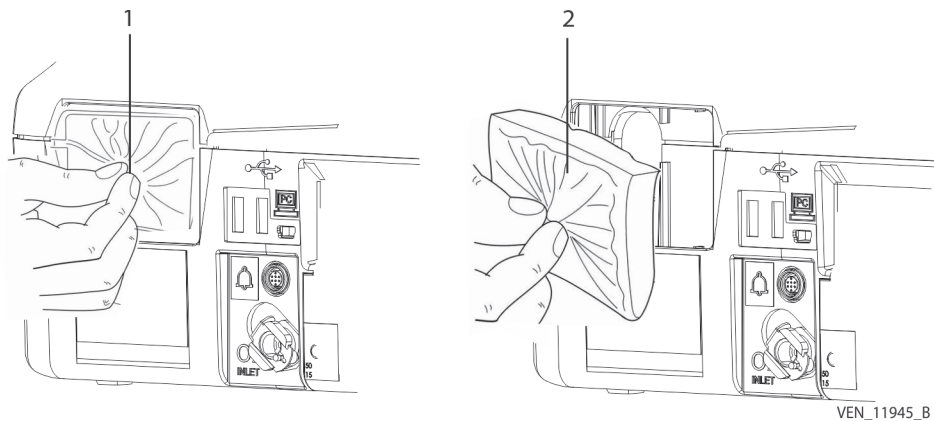
Failing to replace a dirty air inlet filter, or operating the ventilator without a filter, may cause serious damage to the ventilator.



**WARNING:**

The air inlet filter is not reusable; do not attempt to wash, clean, or reuse it.

If the ventilator is used indoors, the condition of the air inlet filter should be checked monthly. If the ventilator is used outdoors or in a dusty environment, the air inlet filter should be checked weekly and replaced as necessary.

**Figure 10-8.** Replacing the Air Inlet Filter**To replace the air inlet filter (see Figure 10-8):**

1. Hold the filter between your fingers (view 1).
2. Remove the filter (view 2) and discard it as instructed by the responsible organization.

**WARNING:**

**Contact local authorities to determine the proper method to dispose of potentially hazardous parts and accessories.**

3. Place the new filter in the device, while ensuring that:
  - a. The fine particle side of the filter faces outwards, away from the ventilator.
  - b. The filter is properly installed in its housing. Proper installation of the filter prevents particles from entering the device.

## 10.6 Recommended Schedule of Maintenance

### 10.6.1 Preventive Maintenance Intervals

Table 10-1 lists the periodic maintenance activities required for the Puritan Bennett™ 560 Ventilator. Total machine hours appear on the welcome screen that appears when turning on the ventilator with the power switch, in the Preferences menu during normal operation, and also when entering maintenance mode.

**Note:**

Only qualified service personnel should open, repair, or service the ventilator.

**Table 10-1.** Preventive Maintenance Schedule

Frequency	Part	Maintenance
As needed	Ventilator external surface	Clean and disinfect. See section 9.1, <i>Cleaning the Ventilator</i> .
	Ventilator dual bag	Clean dual bag regularly (can be machine washed).
According to institutional protocol or manufacturer recommendation	Inspiratory bacteria filter	Replace.
	Exhalation bacteria filter	
	Patient circuit	
	O <sub>2</sub> sensor	The oxygen sensor cannot be immersed in a cleaning or disinfecting solution, nor can it be sterilized. If it becomes contaminated, replace.
With each new patient (also see manufacturer's recommendation)	Inspiratory bacteria filter	Replace.
	Exhalation bacteria filter	Replace. Recalibrate exhalation flow sensor after replacing filter.
	Patient circuit	Replace.
Check or replace once per month or more often.	Air inlet filter	Replace. <b>Note:</b> In particularly dusty environments, replace the air inlet filter more frequently to prevent clogging even if the preventive maintenance period has not elapsed. See section 10.5, <i>Replacing the Air Inlet Filter</i> for air inlet filter replacement instructions.
Every 4 months or with each new patient	Exhalation block <sup>1</sup>	Replace exhalation block and calibrate exhalation flow sensor after reinstallation of exhalation block. See section 10.3, <i>Calibrating the Exhalation Flow Sensor</i> for calibration instructions.
Every 15 000 hours of use	Oxygen solenoid valve	Replace.
	Turbine	Replace.
	Exhalation solenoid valve	Replace.
	Cooling fan	Replace.
Every 14 to 18 months of operation (or more often if persistent calibration failures occur)	FiO <sub>2</sub> sensor	Replace.

**Table 10-1.** Preventive Maintenance Schedule (Continued)

Frequency	Part	Maintenance
Every 2 years	Inspiratory block	Clean and disinfect the inspiratory block using one of the disinfectants listed in <i>Table 9-1</i> . <sup>2</sup>
	Measurements check and calibration	These tasks should be performed by a qualified technician.
	Battery, lithium-ion 4.8 Ah memory	Replace.
	Battery, lithium, 3V	Replace.
	Buzzer PCBA	Replace.

<sup>1</sup> The exhalation block replacement frequency may be 3 months for patients ventilated by tracheotomy more than 12 hours per day. The replacement frequency may be extended to 6 months for patients ventilated less than 12 hours per day, depending on the frequency of technician visits.

The minimum replacement period is based on bench test validation performed under 24/24 continuous ventilation and active humidification conditions over a period of 3 months (test report N°08DE265). Test report results show that no condensation or drops of water that would affect flow measurement were found in the exhalation block or the piezo valve.

<sup>2</sup> To prevent cross contamination, both cleaning and disinfection of the inspiratory block and flow sensor calibration should be considered before new patient use in the event that filters were not used at the inspiratory port or proximal Y piece.

**WARNING:**

**Regularly check the cleanliness of the air inlet filter located on the rear of the ventilator. Replace it when necessary—even before the recommended replacement period has elapsed, and particularly when the ventilator is installed on the wheelchair. Environmental conditions may cause the filter to become dirty more rapidly.**

**WARNING:**

**The exhalation block is intended for single use by a single patient (⊗). It may periodically be cleaned, but it cannot be disinfected or sterilized. To maintain good measurement quality when used continuously, clean the exhalation block periodically (refer to section 9.3, *Cleaning the Exhalation Block*). The exhalation block should be changed every 4 months and cannot be reused with any other patient.**

**Note:**

For a list of parts and accessories, see Appendix *H*, or contact your customer service representative, or consult [www.puritanbennett.com](http://www.puritanbennett.com).

**Note:**

For all additional accessories not necessarily considered as consumables consult the manufacturer's recommendations.

**Note:**

To prevent any risk of cross contamination, Covidien recommends the use of DAR™ filters (Ref: 351/5856 or equivalent) to protect the patient outlet port and the exhalation block port.

Failure to observe these recommendations may result in a loss of performance, excessive overheating, a loss of certain functions and, in the long term, compromise the longevity of the ventilator.

### 10.6.2 Maintenance of the Internal Battery

The internal battery does not need to be removed to verify its correct operation.

### 10.6.3 Periodic Test of the Internal Battery

The ventilator continuously and automatically checks the state of the internal battery, even when the internal battery is not used as the main power source.

However, the battery charge status should be checked MONTHLY by disconnecting the ventilator from external power supplies (see section 8.2, *Battery Operation*). Such a test is imperative after opening the ventilator or after a prolonged period of non-use (1 month or more), in order to ensure the correct operation of internal connections linking the battery to other components.



**WARNING:**

**The maximum recommended shelf life of the internal battery is 2 years. Do not use a battery that has been stored for 2 years prior to its first use.**



**WARNING:**

**Periodic recharging is important to help maximize useful life of the battery. Do not store the internal battery for extended periods, without recharging, as this may reduce the maximum life.**

### 10.6.4 Replacement of the Internal Battery



**WARNING:**

**Do not attempt to replace the battery yourself. Replacement of lithium batteries or fuel cells by inadequately trained personnel could result in a hazard. Replacement must be completed by qualified service personnel only.**

The internal battery should be replaced when the battery capacity drops below 3840 mAh. Keep in mind that, for environmental protection, the ventilator and its components—including its internal battery—cannot be disposed of with household waste. Submit the ventilator and its components for suitable selective collection and possible recycling and observe all applicable regulations.



**Note:**

As the total number of battery charge/discharge cycles approaches 300, a drop in potential of as much as 20% may be detected.



## 10.7 Service Assistance



**WARNING:**

If a problem with the ventilator is suspected, **FIRST CHECK THAT THE PATIENT IS NOT IN DANGER**. If necessary, remove the patient from the ventilator and provide an alternative means of ventilation.



**WARNING:**

**Do not attempt to open, repair or otherwise service the ventilator yourself. Doing so might endanger the patient, damage the ventilator, and/or void your warranty. Only qualified service personnel should open, repair or service the ventilator.**

In the event of a problem with the ventilator, see Chapter 5, *Alarms and Troubleshooting*. If you cannot determine the cause of the problem, contact your equipment supplier or Covidien.

For more information and local Covidien Technical Service Contact details, see the *Service Centers* section in the Preface.

Page Left Intentionally Blank

# A Patient and Caregiver Checklist

## A.1 Overview

This section presents a checklist for patients using the Puritan Bennett™ 560 ventilator, as well as their caregivers.

## A.2 What the Patient and Caregiver Must Understand

Table A-1 presents a summary of the topics that patients and caregivers must understand in order to use the ventilator successfully. Some topics may not apply to some patients, while other patients may require additional information.

## A.3 The Clinician's Responsibility

It is the responsibility of the clinician or clinical educator to ensure that both the patient and the caregiver fully understand the topics listed below.

**Table A-1.** Patient and Caregiver Checklist

List of topics	References
<input type="checkbox"/> Need for ventilation	Clinician
<input type="checkbox"/> Intended use of the ventilator	Chapter 2, <i>Ventilator Overview</i>
<input type="checkbox"/> The principles of operation for the ventilator	Appendix C, <i>Theory of Operation</i>
<input type="checkbox"/> Supplies required for ventilation, and their sources	Clinician; Appendix G, <i>Unpacking and Preparation</i> ; Appendix H, <i>Parts and Accessories</i>
<input type="checkbox"/> Schedule for ventilation	Clinician
<input type="checkbox"/> How and why to monitor the patient's condition.	Clinician
<input type="checkbox"/> The importance of coordinating care for the patient.	Clinician
<input type="checkbox"/> Resources for respite care.	Clinician
<input type="checkbox"/> Choices about future care.	Clinician
<input type="checkbox"/> The purpose of advanced directives.	Clinician

**Table A-1.** Patient and Caregiver Checklist (Continued)

List of topics	References
<input type="checkbox"/> How to check the patient's vital signs.	Clinician
<input type="checkbox"/> The significance of the patient's ease of breathing.	Clinician
<input type="checkbox"/> What to note about the patient's skin, mucus membranes, and secretions, and their significance.	Clinician
<input type="checkbox"/> How to recognize the signs of infection, and how to respond.	Clinician
<input type="checkbox"/> Whom to contact for medical emergencies, equipment emergencies, or power emergencies.	Clinician; section 5.9, <i>Troubleshooting</i> ; section 10.7, <i>Service Assistance</i>
<input type="checkbox"/> Equipment and phone numbers to have available in cases of emergency.	Clinician; Section 10.7, <i>Service Assistance</i>
<input type="checkbox"/> How to contact other resources for assistance (health aides, attendants, therapists, and so on).	Clinician
<input type="checkbox"/> The importance of routine medical appointments and medical testing.	Clinician
<input type="checkbox"/> Power sources for the ventilator and how to connect them	Section 6.2, <i>Connecting to External AC Power</i> and section 6.3, <i>Connecting to an External DC Power Source</i>
<input type="checkbox"/> The meaning of keys and buttons.	Section 2.7, <i>Control Panel</i>
<input type="checkbox"/> The meaning of symbols and markings.	Section 1.3, <i>Symbols and Markings</i>
<input type="checkbox"/> How to connect the patient to the ventilator via the patient breathing circuit.	Section 6.4, <i>Patient Circuit</i>
<input type="checkbox"/> The parts and purpose of the breathing circuit.	Chapter 6, <i>Installation and Assembly</i>
<input type="checkbox"/> How and when to inspect, clean, and replace the patient circuit.	Chapter 1, <i>Safety Information</i> ; Chapter 9, <i>Cleaning</i> ; Section 10.6, <i>Recommended Schedule of Maintenance</i>
<input type="checkbox"/> How to recognize and respond to problems with the breathing circuit.	Chapter 5, <i>Alarms and Troubleshooting</i>
<input type="checkbox"/> The parts and purpose of the nasal interface or mask.	Clinician or manufacturer's instructions for use.
<input type="checkbox"/> Care of the nasal interface or mask.	Clinician or manufacturer's instructions for use.
<input type="checkbox"/> How to recognize and respond to problems with the nasal interface or mask.	Clinician or manufacturer's instructions for use.
<input type="checkbox"/> How to install the humidifier.	Section 6.6, <i>Humidifier</i>
<input type="checkbox"/> How to perform alarms tests, and how to respond if the alarms tests fail.	Appendix F, <i>Alarms Tests</i> ; Chapter 5, <i>Alarms and Troubleshooting</i>
<input type="checkbox"/> How to change the exhalation block.	Section 6.7, <i>Exhalation Block</i>
<input type="checkbox"/> Replacement interval for outlet filters (per the filter manufacturer's instructions).	Section 10.6, <i>Recommended Schedule of Maintenance</i>
<input type="checkbox"/> Setting ventilation parameters and the importance of each	Chapter 3, <i>Operating Parameters</i>

**Table A-1.** Patient and Caregiver Checklist (Continued)

List of topics	References
<input type="checkbox"/> Ventilator alarm settings; understanding the purpose and function of each.	Section 5.8, <i>Overview of Alarms</i>
<input type="checkbox"/> Recognizing alarm priority level	Section 5.2, <i>Alarm Level of Priority</i>
<input type="checkbox"/> What to do in case of ventilator alarms and problems	Section 5, <i>Alarms and Troubleshooting</i>
<input type="checkbox"/> What to do if the ventilator alarms inappropriately.	Section 5.9, <i>Troubleshooting</i>
<input type="checkbox"/> The oxygen setting, and why it is required.	Clinician
<input type="checkbox"/> How to connect the oxygen source to the ventilator	Clinician; section 6.8, <i>Oxygen</i>
<input type="checkbox"/> How to determine the quantity of oxygen being delivered, and how to adjust the quantity.	Clinician; section 6.8, <i>Oxygen</i>
<input type="checkbox"/> Safety rules for the use of oxygen.	Chapter 1, <i>Safety Information</i> ; section 6.8, <i>Oxygen</i>
<input type="checkbox"/> How to connect the FiO <sub>2</sub> sensor to the ventilator	Clinician; section 6.8, <i>Oxygen</i>
<input type="checkbox"/> How to recognize and respond to problems with the oxygen supply.	Clinician
<input type="checkbox"/> How to respond to dyspnea	Clinician
<input type="checkbox"/> Techniques to prevent aspiration of vomit.	Clinician

Page Left Intentionally Blank

# B Specifications

## B.1 Physical

**Table B-1.** Physical Description (excluding accessories)

Ventilator weight	9.9 lb. (4.5 kg)
Ventilator dimensions	9.25 in wide x 12.40 in deep x 6.0 in high (235 mm wide x 315 mm deep x 154 mm high)
Connectors	Inspiratory limb connector: ISO 22 mm (OD) conical Exhalation limb connector (on exhalation block): ISO 22 mm (ID) conical Oxygen inlet: female connector with valve
Device airway volume	2000 ml
Breathing circuit volume	
• Adult, dual limb	1150 ml
• Pediatric, dual limb	670 ml
• Adult, single limb	550 ml
• Pediatric, single limb	300 ml
Air inlet filter	Dimensions: 70 mm long x 60 mm wide Composition: Polypropylene fiber electrostatic filter material, which is laminated onto polyurethane open-celled foam. Efficiency: 99.999982% at 30 lpm (filtering microbes 3.3 µm)
Inspiratory bacteria filter requirement	Maximum allowable flow resistance: 4mbar at 60 lpm

## B.2 Electrical

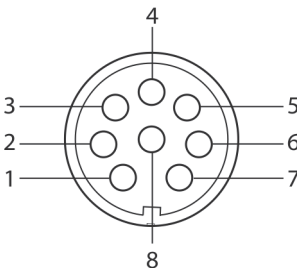
**Table B-2.** Electrical Supply

Voltage (nominal voltage range)	Frequency	Consumption
100 VAC to 240 VAC	50 Hz / 60 Hz	180 VA max
90–250 VAC (rated voltage range)	50 Hz / 60 Hz	180 VA max
12 VDC	N/A	8.3 A
30 VDC	N/A	3.3 A

**Table B-3.** Internal Lithium Ion Battery

Voltage	25.2 VDC
Full-load capacity	4.8 Ah
Ampere-hour rating	On standby: 1.5 Ah
	During ventilation: 0.5 Ah
Watt hour rating	124 Wh to 126 Wh
Charging current	Standby mode: 1.5 A/hr. (duration: <6 hr.)
	Ventilation mode: 0.5 A/hr. (duration: <13 hr.)
Average operating time at 25°C (±5°C) with a fully charged battery (having less than 50 charge/discharge cycles) at the following displayed values:	
Vt = 200 ml (±5 ml), PIP = 10 mbar (±2 mbar), Rate = 20 bpm	11 hr. (-10%)
Vt = 300 ml (±5 ml), PIP = 20 mbar (±2 mbar), Rate = 15 bpm	9 hr. (-10%)
Vt = 500 ml (±5 ml), PIP = 30 mbar (±2 mbar), Rate = 15 bpm	6.5 hr. (-10%)
Vt = 750 ml (±5 ml), PIP = 45 mbar (±2 mbar), Rate = 20 bpm (maximum settings)	4.5 hr. (-10%)

**Table B-4.** Remote Alarm

<p>Remote alarm port: Also known as the nurse call port, it provides for remote alerts of ventilator alarm conditions. An example of a setting that requires such a feature is when the ventilator is used in an isolation room.</p> <p>The ventilator signals an alarm using a normally open (NO) or a normally closed (NC) signal. A remote alarm is activated when an alarm condition occurs, unless the audio paused function is active or the ventilator power switch is turned off.</p> <p>The alarm delay, once generated from the ventilator, to the nurse call output/input cable connectors is less than 100 ms.</p> <p>The remote alarm port is an 8-pin female connector. Allowable current is 100 mA at 24 VDC (maximum).</p>	 <p>Nurse call pin-out (view from rear of ventilator)</p>
--	---

Pin	Signal	Remote alarm wire color
1	Relay common	Black
2	Normally open (NO)	Brown
3	Normally closed (NC)	Orange
4	Remote supply— (not used)	N/A
5	RX signal (not used)	N/A
6	TX signal (not used)	N/A
7	Remote supply + (not used)	N/A
8	Not used	N/A



## B.3 Indicators and Alarms

**Table B-5.** Power Indicators

Ventilation ON/OFF	AC power	DC power	Internal battery
<ul style="list-style-type: none"> <li>• Blue in standby mode</li> <li>• Not lit if ventilation is in progress.</li> </ul>	Green	Green	<ul style="list-style-type: none"> <li>• Flashing if the battery charge is in progress.</li> <li>• Continuously lit if the ventilator is powered by the internal battery.</li> </ul>

**Table B-6.** Alarm Indicators

High priority	Medium priority	Low priority
Red flashing LED	Yellow flashing LED	Yellow continuously lit LED

**Table B-7.** Audio Alarms

Audio paused	Alarm volume	Power down alarm volume
60 s $\pm$ 1 s	50 dBA to 80 dBA (Alarm volume setting MIN to alarm volume setting MAX) Measurement uncertainty: $\pm$ 3 dBA	Minimum 65 dBA

## B.4 Performance

### B.4.1 Specifications



**Note:**

Performance specifications listed are applicable when dry gases are used in the patient system.

**Table B-8.** Performance Parameter Specifications and Tolerances<sup>1</sup>

Settings	Range	Tolerances
Volume	50 to 2000 ml	$\pm$ (10 ml +15%)
Pressure	5 to 55 mbar	$\pm$ (1 mbar +10%)
Time	0.3 to 6.0 s	$\pm$ 10%
Rate	1 to 60 bpm	$\pm$ 1 bpm
Inspiratory Sensitivity	0P to 5	N/A
Exhalation Sensitivity	5 to 95%	$\pm$ (4 lpm +10% of target exhalation flow) based on E Sens within 50ms
Vt Sigh	Vt $\times$ 1 to Vt $\times$ 2	$\pm$ (20ml +20%)
I:E Ratio	1:4 to 1:1	Insp. time $\pm$ 50 ms and Exh. time $\pm$ 50 ms or I:E ratio $\pm$ 10%, whichever is greater
I/T Ratio	20% to 50%	Insp. time $\pm$ 50 ms and Exh. time $\pm$ 50 ms or I/T ratio $\pm$ 10%, whichever is greater

1. The ventilator parameters' displayed values could vary based on patient settings.

## B.4.2 Measurement Uncertainty

Measurement uncertainties and the manner in which they are applied are listed in [Table B-9](#).

**Table B-9.** Performance Verification Equipment Uncertainty

Measured Parameter	Offset	Gain
Flow	0.05 SLPM <sup>1</sup>	2% reading <sup>1</sup>
Volume	--	1.59% reading
Pressure	0.20 cmH <sub>2</sub> O	1.53% reading
Oxygen concentration	--	0.4% reading
Temperature	1.1 °C	±1 bpm
Atmospheric pressure	2.04 cmH <sub>2</sub> O	--

1. Whichever is greater

During breath delivery performance verification for flow and pressure based measurements, the equipment inaccuracy is subtracted from the acceptance specification as follows:

- Net acceptance gain = Requirement specification gain – Measurement uncertainty gain
- Net acceptance offset = Requirement specification offset – Measurement uncertainty offset
- Acceptance limit = ±[(Net acceptance offset) + (Net acceptance gain) × (Setting)]
- (Setting – Acceptance limit) ≤ Measurement ≤ (Setting + Acceptance limit)

For derived parameters, such as volume, the individual sensor uncertainties are combined and applied as applicable to determine the acceptance limits.

## B.5 Monitored Parameters

**Table B-10.** Monitored Parameter Tolerances

Ventilator parameter	Tolerances
Peak Inspiratory Pressure (PIP)	±(2 mbar +4%)
Positive End Expiratory Pressure (PEEP) <sup>1</sup>	±(2 mbar +4%)
Inspiratory Tidal Volume (VTI)	± (10 ml +15%) and ±(20 mL +20%) in CPAP mode above 200 mL or in NIV configuration
Exhalation Tidal Volume (VTE)	± (10 ml +15%)
Total Breath Rate (Rtot)	±1 bpm
I:E Ratio (I:E)	Insp. time ±50 ms and Exh. time ±50 ms or I:E ratio ±10%, whichever is greater
I/T Ratio (I/T)	Insp. time ±50 ms and Exh. time ±50 ms or I/T ratio ±10%, whichever is greater
Inspiratory Time (I Time)	±100 ms

**Table B-10.** Monitored Parameter Tolerances (Continued)

Ventilator parameter	Tolerances
Exhalation Time (E Time)	±100 ms
Inspiratory Minute Volume (M Vol)	±(10 mL +15% VTI) ×Rate (with exhalation valve) and ±(20 mL +20% VTI) ×Rate in NIV configuration (without exhalation valve)
Vt Sigh	±(20ml +20%)
FiO <sub>2</sub>	±(2.5% +2.5% FiO <sub>2</sub> )
Leak	±(3 lpm +20%)
Apnea Index (AI)	±1 ev/h
Apnea Time	±1 s
% Spontaneous (Spont)	±1%
Peak Airway Pressure (Paw)	±(2 mbar +4%)

1. The Puritan Bennett™ 560 ventilator does not have the capability to reduce pressure below the PEEP pressure during the exhalation phase.

## B.6 Range, Resolution, and Accuracy

Table *B-11* lists the ranges, resolutions, and accuracies for ventilator settings, alarm settings, and patient data.

**Table B-11.** Ventilator Range, Resolution, and Accuracy

Ventilator settings	Range, resolution, and accuracy
Mode	Range: V A/C, P A/C, V SIMV, P SIMV, PSV, CPAP Resolution: N/A Accuracy: N/A Default value: P A/C
Tidal volume (Vt)	Range: 50 mL to 2000 mL Resolution: 10 mL Accuracy: ±(10 ml +15%) of setting Default value: 500 mL Depends on: Insp time, R-Rate in V SIMV and P SIMV Depends on: Rate and I:E (I/T) in V A/C
Vt Target	Range: 50 mL to 2000 mL Resolution: 10 mL Accuracy: Vt target < VTI < Vt target +20% if Max P is high enough to reach Vt target Default value: OFF (100 mL)
Inspiratory Pressure (Pi)	Range: 5 mbar to 55 mbar in valve configuration Range: 6 mbar to 30 mbar in leak configuration Resolution: 1 mbar Accuracy: ±(1 mbar +10%) of Pi + PEEP setting Default value: 15 mbar Depends on: PEEP when Relative Pressure is set to YES

**Table B-11.** Ventilator Range, Resolution, and Accuracy (Continued)

Ventilator settings	Range, resolution, and accuracy
Pressure support (P Support)	Range: OFF or 5 mbar to 55 mbar in valve configuration Range: 6 mbar to 30 mbar in leak configuration Resolution: 1 mbar Accuracy: $\pm(1 \text{ mbar} + 10\%)$ of P Support + PEEP setting Default value: 15 mbar Depends on: PEEP when Relative Pressure is set to YES
I:E Ratio (I:E)	Range: 1:1 to 1:4 Resolution: 1/0.1 Accuracy: Insp. time $\pm 50$ ms and Exh. time $\pm 50$ ms or I:E ratio $\pm 10\%$ , whichever is greater Default value: 1:2
I/T Ratio (I/T)	Range: 20% to 50% Resolution: 1% Accuracy: Insp. time $\pm 50$ ms and Exh. time $\pm 50$ ms or I/T ratio $\pm 10\%$ , whichever is greater Default value: 33%
Inspiratory time (Insp Time)	Range: 0.3 s to 6.0 s in P A/C and V A/C modes; 0.3 s to 2.4 s in P SIMV and V SIMV modes Resolution: 0.1 s Accuracy: $\pm 10\%$ Default value: 1.5 s Depends on: R-Rate, Vt in V SIMV mode Depends on: R-Rate in P SIMV mode
Respiratory rate (R-Rate)	Range: 1 bpm to 60 bpm in V A/C and P A/C modes 1 bpm to 40 bpm in P SIMV and V SIMV modes Resolution: 1 bpm Accuracy: $\pm 1$ bpm Default value: 13 Depends on: Insp Time and Vt in V SIMV mode Depends on: Insp Time in P SIMV modes Depends on: Vt in V A/C mode
Inspiratory sensitivity (I Sens)	Range: 0P to 5 Resolution: 1 Accuracy: N/A Default value: 2 In CPAP, I Sens is set to 2 and is not adjustable
Exhalation sensitivity (E Sens)	Range: 5% to 95% of peak flow Resolution: 5% Accuracy: $\pm(4 \text{ lpm} + 10\%$ of target exhalation flow) based on E Sens within 50ms Default value: 25% In CPAP, E Sens is fixed at 25% and is not adjustable

**Table B-11.** Ventilator Range, Resolution, and Accuracy (Continued)

Ventilator settings	Range, resolution, and accuracy
Ramp (Flow Pattern)	Range: Square (SQ), descending ramp (D), sinusoidal (S) Resolution: N/A Default value: Descending ramp (D) In V SIMV, flow pattern is set to square and is not adjustable
PEEP	Range: OFF (0.5 mbar) to 20 mbar Resolution: 1 mbar Accuracy: $\pm(1 \text{ mbar} + 10\%) \text{ mbar}$ Default value: OFF Depends on: Pi in P A/C and PSV modes when Relative Pressure is set to YES Depends on: P Support and Pi in P SIMV mode when Relative Pressure is set to YES Depends on: P Support in V SIMV mode when Relative Pressure is set to YES
Rise time	Range: 1 to 4 Resolution: 1 Default value: 2 Depends on: Insp time
Backup rate	Range: OFF or 4 to 40 bpm Resolution: 1 bpm Default value: 13 Depends on: Min I time In P SIMV and V SIMV, Backup rate = Max (8, R-Rate)
Apnea time	Range: AUTO or 1 to 60 s Resolution: 1 s Default value: AUTO Depends on: Backup R In PSV, Apnea time: AUTO = 60/Backup R In V SIMV or P SIMV, Apnea Time: AUTO = 12 In CPAP, Apnea Time: AUTO = 30
Minimum Inspired Tidal Volume (Min VTi)	Range: 30 mL to 2000 mL Resolution: 10 mL Default value: 300 Depends on: Max VTi
Maximum Inspired Tidal Volume (Max VTi)	Range: 80 mL to 3000 mL Resolution: 10 mL Default value: 2000 mL Depends on: Min VTi
Minimum Exhaled Tidal Volume (Min VTE)	Range: 30 mL to 1990 mL Resolution: 10 mL Default value: 300 Depends on: Max VTE

**Table B-11.** Ventilator Range, Resolution, and Accuracy (Continued)

<b>Ventilator settings</b>	<b>Range, resolution, and accuracy</b>
Maximum Exhaled Tidal Volume (Max VTE)	Range: 80 mL to 3000 mL Resolution: 10 mL Default value: 1000 Depends on: Min VTE
Maximum Respiratory Rate (Max Rtot)	Range: 10 bpm to 70 bpm in CPAP, P A/C, and V A/C modes and 17 bpm to 70 bpm in P SIMV and V SIMV modes Resolution: 1 bpm Default value: OFF Depends on: R-Rate
Minimum Peak Inspiratory Pressure (Min PIP)	Range: PIP-20% (not adjustable in pressure breath) Range: 2 to 52 (V SIMV); 2 to 82 (V A/C) Resolution: 1 Default value: 2 Depends on: PEEP, Max PIP
Maximum Peak Inspiratory Pressure (Max PIP)	Range: PIP+20% (not adjustable in pressure breath) Range: 12 to 90 in volume breath Resolution: 1 Default value: 40 Depends on: PEEP, Min PIP
Minimum inspiratory time (Min I time)	Range: 0.1 to 2.8 s Resolution: 0.1 s Default value: AUTO (Rise time + 300 ms) Depends on: Max I Time, Backup R, Rise time
Maximum inspiratory time (Max I time)	Range: 0.8 to 3 s Resolution: 0.1 s Default value: AUTO (minimum of 3 s or 30/monitored rate) Depends on: Min I Time, R-Rate
Minimum Fraction of Inspired Oxygen (Min FiO <sub>2</sub> )	Range: 18 to 90% Resolution: 1% Default value: OFF Depends on: Max FiO <sub>2</sub>
Maximum Fraction of Inspired Oxygen (Max FiO <sub>2</sub> )	Range: 30 to 100% Resolution: 1% Default value: OFF Depends on: Min FiO <sub>2</sub>

## B.7 Environmental

The following environmental conditions shall be observed:

**Table B-12.** Environmental Conditions for Storage or Transport

Temperature	Humidity	Atmospheric pressure	Altitude
-40°C to +70°C (-40°F to +158°F)	10% to 95% RH	500 hPa to 1060 hPa (7.2 psi to 15.4 psi)	-152 m to 3964 m (500 ft to 13 000 ft)

**Table B-13.** Environmental Conditions for Operation

Temperature	Humidity	Atmospheric pressure	Altitude
+5°C to 40°C (+41°F to 104°F)	10% to 95% RH	600 hPa to 1100 hPa (8.7 psi to 16.0 psi)	-152 m to 3964 m (500 ft to 13 000 ft)

Under extreme conditions of use, within the limits of a supply voltage of –20% and temperatures ranging from normal to 45°C (113°F) with ≤75% RH, the ventilator should not malfunction nor endanger the user. However, operating the device for prolonged periods or repeatedly under such extreme conditions could result in premature aging of components and more frequent maintenance.

## B.8 USB

**Table B-14.** USB Memory Device Specifications

Characteristics	Supported formats
USB compatibility	USB flash memory USB 2.0 or USB 1.1
Memory file format	USB 32 bit format (sector size: 512 - 2048 bytes)
Number of files	Maximum 999
USB size	128 MB to 4 GB

**Table B-15.** Data Transfer Characteristics

Ventilator data description	Capacity
Trends capacity	86 MB
Events capacity	512 KB or 5500 events
Monitoring capacity	42 MB /48 hours

## B.9 Pneumatic

**Table B-16.** Airway Resistances

Inspiratory	Exhalation
1.0 mbar at 30 lpm flow $\pm 0.1$ mbar	0.5 mbar at 30 lpm $\pm 0.1$ mbar
3.7 mbar at 60 lpm flow $\pm 0.1$ mbar	1.1 mbar at 60 lpm $\pm 0.1$ mbar

**Table B-17.** Patient Circuit Resistances<sup>1</sup>

Adult double limb	Pediatric double limb
$\leq 2$ mbar at 60 lpm flow <sup>2</sup>	$\leq 2$ mbar at 30 lpm flow

1. Includes exhalation valve.
2. Values obtained from the manufacturer's directions for use.

**Table B-18.** Air Inlet Resistance (Filter)

1.1 cmH <sub>2</sub> O (1.079 mbar) at 30 lpm flow $\pm 0.1$ cmH <sub>2</sub> O
---

**Table B-19.** Oxygen Inlet Specifications

Maximum pressure	Maximum flow
50 kPa (7 psi)	15 lpm

**Table B-20.** Performance Specifications

<b>Working pressure</b>	5 mbar–55 mbar
<b>Sound pressure level</b>	30 dBA (per NF EN ISO 17510-1 test conditions) Does not exceed 55 dBA per EN ISO 80601-2-72 test conditions
<b>Sound power level</b>	Does not exceed 63 dBA per EN ISO 80601-2-72 test conditions
<b>Maximum pressure limit</b>	90 mbar
<b>Internal compliance (ventilator)</b>	0.0001 l/mbar
<b>Inspiratory triggering response time (T<sub>tr</sub>)</b>	100 ms
<b>Average total system response time to change FiO<sub>2</sub> from 21% to 90% O<sub>2</sub></b>	<30 s
<b>Drift of measurement accuracy</b>	FiO <sub>2</sub> monitor will meet the accuracy requirements for at least 6 hours after the O <sub>2</sub> sensor has been calibrated, and when used in accordance with the instructions for use.



## B.10 Manufacturer's Declaration

Tables *B-21* through Table *B-24* contain the manufacturer's declarations for the ventilator's electromagnetic emissions, electromagnetic immunity, and recommended separation distances between the ventilator and portable and mobile RF communications equipment, as well as a list of compliant cables.



**WARNING:**

Portable and mobile RF communications equipment can affect the performance of the Puritan Bennett™ 560 Ventilator. Install and use this device according to the information contained in this manual.

Interference may occur in the vicinity of equipment marked with the following symbol: 



**WARNING:**

The ventilator should not be used adjacent to or stacked with other equipment, except as specified in this manual. If adjacent or stacked use is necessary, the ventilator should be observed to verify normal operation in the configurations in which it will be used.



**WARNING:**

This equipment has been tested and found to comply with the EMC limits for IEC 60601-1-2 (EN 60601-1-2), the EMC Collateral Standard. These limits are designed to provide reasonable protection against harmful interference in a typical medical installation. The equipment generates, uses, and can radiate radio frequency energy and, if not installed and used in accordance with these instructions, may cause harmful interference to other devices in the vicinity or may cause degradation of the performance of this equipment. However, there is no guarantee that interference will not occur in a particular installation.

If this equipment does cause harmful interference with other devices, which can be determined by turning the equipment off and on, the user is encouraged to try to correct the interference by one or more of the following measures:

- Reorient or relocate the receiving device.
- Increase the separation between the equipment.
- Connect the equipment to an outlet on a circuit different from that to which the other device or devices are connected.
- Consult the manufacturer or field service technician for assistance.

**Table B-21.** Electromagnetic Emissions

<b>The ventilator is intended for use in the electromagnetic environment specified below.                      The customer or the user of the ventilator should ensure that it is used in such an environment.</b>		
Phenomenon and standard	Compliance	Electromagnetic environment – guidance
Conducted and radiated RF emissions CISPR 11/EN 55011	Group 1 Class B	The ventilator uses RF energy only for its internal functions. Therefore, its RF emissions are very low and are not likely to cause any interference in nearby electronic equipment.
Harmonic emissions IEC 61000-3-2	Class A	The ventilator is suitable for use in all establishments including domestic establishments and those directly connected to the public low-voltage power supply network that supplies buildings used for domestic purposes.
Voltage fluctuations and flicker IEC 61000-3-3	Complies	

**Table B-22.** Electromagnetic Immunity

Phenomenon	Basic EMC standard or test method	Immunity test levels for Home Healthcare environment
Electrostatic discharge	IEC/EN 61000-4-2	± 8kV contact ±2 kV, ±4 kV, ±8 kV, ±15 kV air
Electrical fast transients/bursts	IEC/EN 61000-4-4	±2 kV for power supply lines ±1 kV for input/output lines 100 kHz repetition frequency
Surge	IEC/EN 61000-4-5	± 0,5 kV, ± 1 kV line-to-line ± 0,5 kV, ± 1 kV, ± 2 kV line-to-ground
Voltage dips	IEC/EN 61000-4-11	0% UT; 0,5 cycle At 0°, 45°, 90°, 135°, 180°, 225°, 270° and 315° 0% UT; 1 cycle and 70% UT; 25/30 cycles Single phase: at 0°
Voltage interruptions	IEC/EN 61000-4-11	0% UT; 250/300 cycle
Rated power frequency magnetic field	IEC/EN 61000-4-8	30 A/m (50/60 Hz)
<b>NOTE:</b> UT is the AC mains voltage prior to application of the test level.		

**Table B-23.** Electromagnetic Immunity—Conducted and Radiated RF

Phenomenon	Basic EMC standard or test method	Immunity test levels for Home Healthcare environment
Conducted disturbances induced by RF fields	IEC/EN 61000-4-6	3 V 0,15 MHz–80 MHz 6 V in ISM and amateur radio bands <sup>1</sup> between 0,15 MHz and 80 MHz 80% AM at 1 kHz
Radiated RF EM fields	IEC/EN 61000-4-3	10 V/m 80 MHz to 2.7 GHz 80% AM at 1 kHz
Proximity fields from RF wireless communications equipment	IEC/EN 61000-4-3	27 V/m, 18 Hz PM <sup>2</sup> , 385 MHz 28 V/m, 18 Hz PM, 450 MHz 9 V/m, 217 Hz PM, 710 MHz 9 V/m, 217 Hz PM, 745 MHz 9 V/m, 217 Hz PM, 780 MHz 28V/m, 18 Hz PM, 810 MHz 28 V/m, 18 Hz PM, 870 MHz 28 V/m, 18 Hz PM, 930 MHz 28V/m, 217 Hz PM, 1720 MHz 28 V/m, 217 Hz PM, 1845 MHz 28 V/m, 217 Hz PM, 1970 MHz 27 V/m, 217 Hz PM, 2450 MHz 9V/m, 217 Hz PM, 5240 MHz 9 V/m, 217 Hz PM, 5500 MHz 9 V/m, 217 Hz PM, 5785 MHz

1. The ISM (industrial, scientific, and medical) bands between 0,15 MHz and 80 MHz are 6,765 MHz to 6,795 MHz; 13,553 MHz to 13,567 MHz; 26,957 MHz to 27,283 MHz; and 40,66 MHz to 40,70 MHz. The amateur radio bands between 0,15 MHz and 80 MHz are 1,8 MHz to 2,0 MHz; 3,5 MHz to 4,0 MHz; 5,3 MHz to 5,4 MHz; 7 to 7,3 MHz; 10,1 MHz to 10,15 MHz; 14 MHz to 14,2 MHz; 18,07 MHz to 18,17 MHz; 21,0 MHz to 21,4 MHz; 24,89 MHz to 24,99 MHz; 28,0 MHz to 29,7 MHz; and 50,0 MHz to 54,0 MHz.
2. PM is the Pulse Modulation.

**Table B-24.** Compliant Cables and Accessories

Cable or accessory	Maximum length
UK AC power cable assembly	1.8 m (5.9 ft)
Japan AC power cable assembly	1.8 m (5.9 ft)
China AC power cable assembly	1.8 m (5.9 ft)
South Africa AC power cable assembly	1.8 m (5.9 ft)
India AC power cable assembly	1.8 m (5.9 ft)
Australia AC power cable assembly	1.8 m (5.9 ft)
Europe AC power cable assembly	1.8 m (5.9 ft)
Canada AC power cable assembly	1.8 m (5.9 ft)

**Table B-24.** Compliant Cables and Accessories (Continued)

Cable or accessory	Maximum length
Nurse call cable	5 m (16.4 ft)
12V DC car adapter cable	5 m (16.4 ft)
Oxygen inlet connector	n/a
Puritan Bennett™ power pack (4098100)	n/a

## B.11 Standards Compliance and IEC Classification

### B.11.1 General Standards

- Medical Electrical Equipment: General Requirements for Safety IEC 60601-1.
- The ventilator will be constructed to comply with the following product classifications as detailed in Clause 5 of 60601-1:
  - Class II Equipment
  - Internally Powered Equipment
  - Type BF Applied Parts
  - IP32 with respect to access to hazardous parts and ingress of moisture
  - Not suitable for use in the presence of flammable anesthetic mixtures
  - Not suitable for sterilization
  - Suitable for continuous operation
  - Detachable power supply cable
- CAN/CSA-C22.2 No. 60601-1, Medical Electrical Equipment - Part 1: General requirements for basic safety and essential performance

### B.11.2 Collateral Standards

- Medical Electrical Equipment - Part 1: General Requirements for Safety -2- Collateral standard Electro-Magnetic Compatibility requirements and tests IEC 60601-1-2 and EN 60601-1-2.
- Medical Electrical Equipment - Part 1: General Requirements for Safety -2- Collateral standard: Usability IEC 60601-1-6 and EN 60601-1-6.
- General Requirements, tests, and guidance for alarm systems in medical electrical equipment and medical electrical systems IEC 60601-1-8 and EN 60601-1-8.

### **B.11.3 Particular Standards**

- Particular requirement for basic safety and Essential performance of home healthcare environmental ventilators for ventilator-dependent patients – EN ISO 80601-2-72.
- Anesthetic and respiratory equipment - Conical connectors - Part 1: Cones and sockets EN ISO 5356-1.

### **B.11.4 Air Transportation Standards**

- Environmental Conditions and Test Procedures for Airborne Equipment - RTCA/DO-160.

Page Left Intentionally Blank

# C Theory of Operation

## c.1 Architecture

The Puritan Bennett™ 560 ventilator's gas delivery system is primarily composed of an airflow generator and a three-way valve to control the patient circuit exhalation valve. The flow generator is a low-inertia, micro-turbine driven by a brushless DC electric motor, while the three-way valve is a proportional solenoid valve.

These two actuators are microprocessor-controlled and perform according to specific control algorithms. The microprocessor control circuit receives its data from the various servo-controlled pressure and feedback flow sensors that are built into the ventilator.

An electrical supply management system performs the energy conversion so the device can switch between the three available power sources to provide power to the internal electronics.

A cooling fan helps maintain the proper operating temperature range for the internal environment of the ventilator. This fan is servo-controlled to maintain the proper temperature for the most heat-sensitive of the ventilator's components.

## c.2 Operation

The operation of the device is based on a self-adapting, closed loop drive system. The speed of the flow generator (turbine) is servo-controlled according to the patient pressure signal or the inspired flow signal.

The turbine speed control algorithms themselves are based on equations that vary according to the ventilation modes, settings, and the respiratory cycle phases. Thus, fixing the pressure rise time or flow pattern has an influence on the level of turbine acceleration at the start of the inspiration phase. The transition between the inspiration phase and expiration phase is controlled by a deceleration or braking algorithm proportional to the pressure difference between the two phases.

The exhalation solenoid valve (three-way valve) is fully closed during the inspiratory phase and is proportionally controlled during the exhalation phase to obtain the bias flow. The speed of the turbine adapts to the exhalation pressure threshold during the entire exhalation phase to maintain the operator-set PEEP.

The flow measurement completes the system by enabling detection of patient inspiratory effort and the triggering of inspiration phases. The flow measurement can also be used to determine the end of the inspiration phase in certain ventilation modes.

The flow measurement is automatically corrected as a function of the atmospheric pressure measured inside the ventilator with the altitude compensation feature. The flow and volume are in Body Temperature Pressure Saturated (BTPS) conditions. This necessitates that periodic inspections for calibrating the sensors be performed by maintenance technicians authorized by Covidien (see the service manual).

If the altitude compensation feature is active, a corrective algorithm is applied to the inspiration and exhalation flow for volume calculation and the flow set point in volume breath.

The sensor measurement range is software limited from 600 to 1100 hPa.

A cooling fan is provided to maintain the internal temperature of the ventilator within specified limits and to help ensure proper performance and longevity of the device.

Finally, the various measurement signals used in control and detection are protected and specifically filtered in order to limit any risk of disturbance to the device and possible problem.

For an illustration of the ventilator's gas delivery system, see Figure 9-1 on page 9-3.



**Note:**

The altitude compensation feature is enabled (set to "YES" on the Setup screen) by default and should remain at this setting.



# D Modes and Breath Types

## D.1 Modes of Ventilation

This chapter is a general description of the various modes of ventilation and breath types available with the Puritan Bennett™ 560 ventilator.



**Note:**

The default ventilation mode setting is P A/C; for more information, see below.

### D.1.1 Assist/Control (A/C) Modes

When set to an Assist/Control mode, machine-initiated breaths are delivered at a clinician-set volume or pressure, inspiratory time, and rate. If the patient triggers a spontaneous breath between machine breaths, the ventilator will deliver a breath based on the volume or pressure settings and inspiratory time.

Whether initiated by the patient or the ventilator, all breaths are delivered at the same preset volume or pressure and inspiratory time.

The names of the Assist/Control modes are:

- V A/C, if the breaths are based on a volume setting
- P A/C, if the breaths are based on a pressure setting

### D.1.2 SIMV Modes

When set to a SIMV (Synchronized Intermittent Mandatory Ventilation) Mode, machine-initiated breaths are delivered at a clinician-set volume or pressure, inspiratory time, and rate. These mandatory breaths are synchronized with patient effort. If the patient triggers a spontaneous breath between machine breaths, the ventilator will deliver a spontaneous breath, which is pressure-supported.

CPAP spontaneous breaths are not available in SIMV modes.

The names of the SIMV modes are:

- V SIMV, if mandatory breaths are based on a volume setting
- P SIMV, if mandatory breaths are based on a pressure setting

### D.1.3 CPAP Mode

In CPAP mode, the ventilator maintains a constant level of pressure in the patient's airway.

### D.1.4 PSV Mode

PSV mode maintains a constant level of pressure in the patient's airway during exhalation. In addition, the ventilator applies a clinician-set pressure (Pressure Support) to each of the patient's breaths. This has the same benefits as CPAP, with the additional benefit of assisting the patient in moving gas into his or her lungs.

## D.2 Breath Types

The following breath types are available from the ventilator:

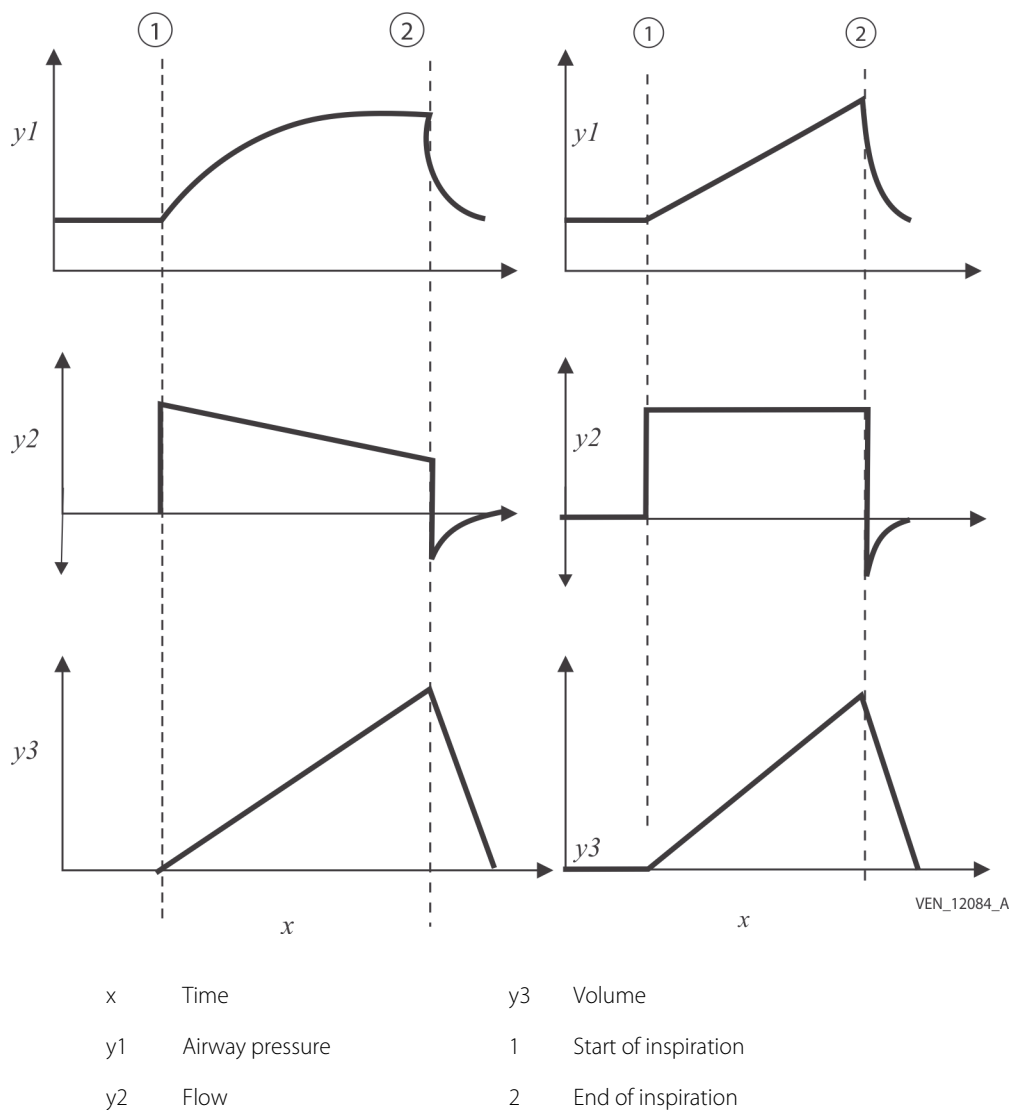
- Volume controlled breaths in Assist/Control mode (in V A/C or V SIMV)
- Pressure controlled breaths in Assist/Control mode (in P A/C or P SIMV)
- Pressure-supported breaths in SIMV mode (V SIMV and P SIMV) or PSV
- CPAP

### D.2.1 Volume Breaths in Assist/Control Mode

In V A/C mode, each delivered breath will be of the selected volume ( $V_t$ ), delivered over the selected inspiratory time. Inspiration is triggered by patient-generated flow (for assisted breaths) or by the ventilator. For controlled breaths, breath rate (R-Rate) is the controlling parameter. For both controlled and assisted breaths, the inspiration is limited by the volume and is cycled by inspiratory time (Insp Time).

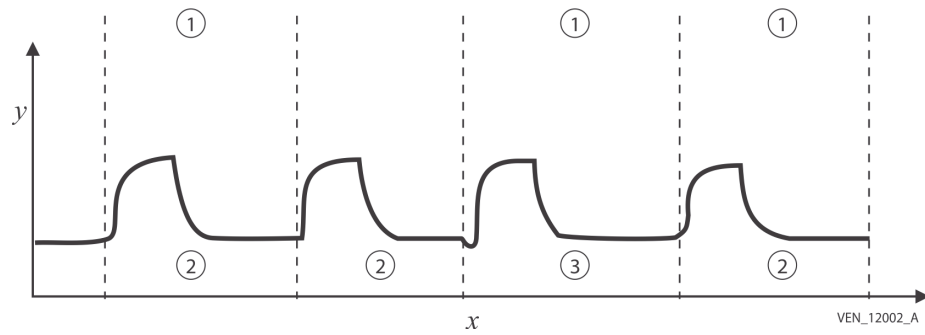
The shape of the flow waveform can be either a decelerated (D), a (SQ) square, or sinusoidal (S) flow patterns according to the Flow Pattern setting. See [Figure D-1](#).

Figure D-1. Waveforms (Volume Breaths in A/C Mode)



A/C mode guarantees a maximum period between breaths, as determined by the Breath Rate setting. In the waveform below, the ventilator delivers a controlled (machine) breath, and calculates the time before another controlled breath must be delivered. The ventilator delivers a second controlled breath at the conclusion of the machine calculated breath time (for simplicity, we will use the term period for “machine-calculated breath time”). Following the second controlled breath, but before another period can elapse, the patient's effort triggers an assisted (or patient-initiated) breath. This restarts the period. At the conclusion of the period, the ventilator delivers another controlled breath. See [Figure D-2](#).

**Figure D-2. A/C Mode Breaths**



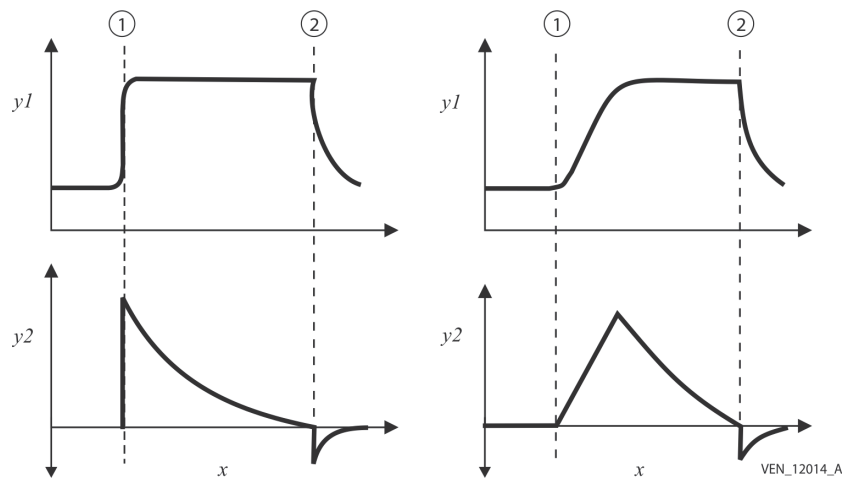
- |   |                 |   |                          |
|---|-----------------|---|--------------------------|
| x | Time            | 2 | Machine breath           |
| y | Airway pressure | 3 | Patient-initiated breath |
| 1 | Period          |   |                          |

### D.2.2 Pressure Control Breaths in Assist/Control Mode

In Assist/Control mode (P A/C), each delivered breath will maintain the selected pressure ( $P_i$ ) maintained over the selected inspiratory time. Inspiration is triggered by patient-generated flow (for assisted breaths) or by the ventilator (for controlled breaths; breath rate [R-Rate] is the controlling parameter). For both controlled and assisted breaths, the inspiratory pressure is limited to the pressure ( $P_i$ ) setting, and is cycled by time.

The shape of the pressure waveform depends on the setting of the pressure rise time (Rise Time). See [Figure D-3](#).

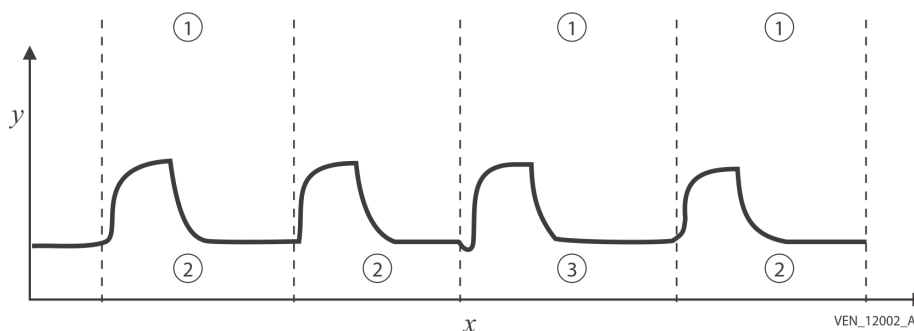
**Figure D-3. Waveforms (Pressure Control Breaths in A/C Mode)**



- |    |                 |   |                      |
|----|-----------------|---|----------------------|
| x  | Time            | 1 | Start of inspiration |
| y1 | Airway pressure | 2 | End of inspiration   |
| y2 | Flow            |   |                      |

P A/C mode guarantees a maximum period between breaths, as determined by the Breath Rate setting. In the next waveform (shown on the following page), the ventilator delivers a controlled (machine) breath, and calculates the time before another controlled breath must be delivered. The ventilator delivers a second controlled breath at the conclusion of the machine calculated breath time (for simplicity, we will use the term period for “machine-calculated breath time”). Following the second controlled breath, but before another period can elapse, the patient's effort triggers an assisted (or patient-initiated) breath. This restarts the period. At the conclusion of the period, the ventilator delivers another controlled breath. See [Figure D-4](#).

**Figure D-4.** P A/C Mode Breaths



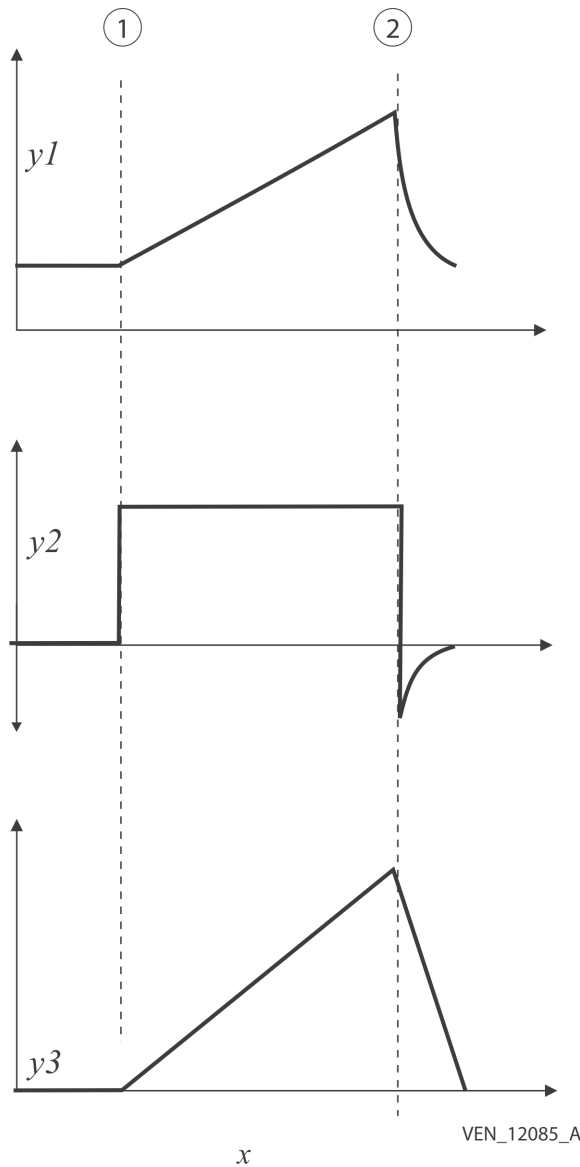
x	Time	2	Machine breath
y	Airway pressure	3	Patient-initiated breath
1	Period		

### D.2.3 Volume Breaths in V SIMV Mode

In V SIMV the mandatory volume breaths deliver the selected volume ( $V_t$ ) over the selected inspiratory time (Insp Time). Inspiration is triggered by patient-generated flow (for assisted breaths) or by the ventilator (for controlled breaths; breath rate [R-Rate] is the controlling parameter). For both controlled and assisted breaths, the inspiration is limited by the volume and is cycled by volume and time.

The shape of the flow of volume cycles is of the Square type. See [Figure D-5](#).

**Figure D-5.** Waveforms (Volume Breaths in V SIMV Mode)



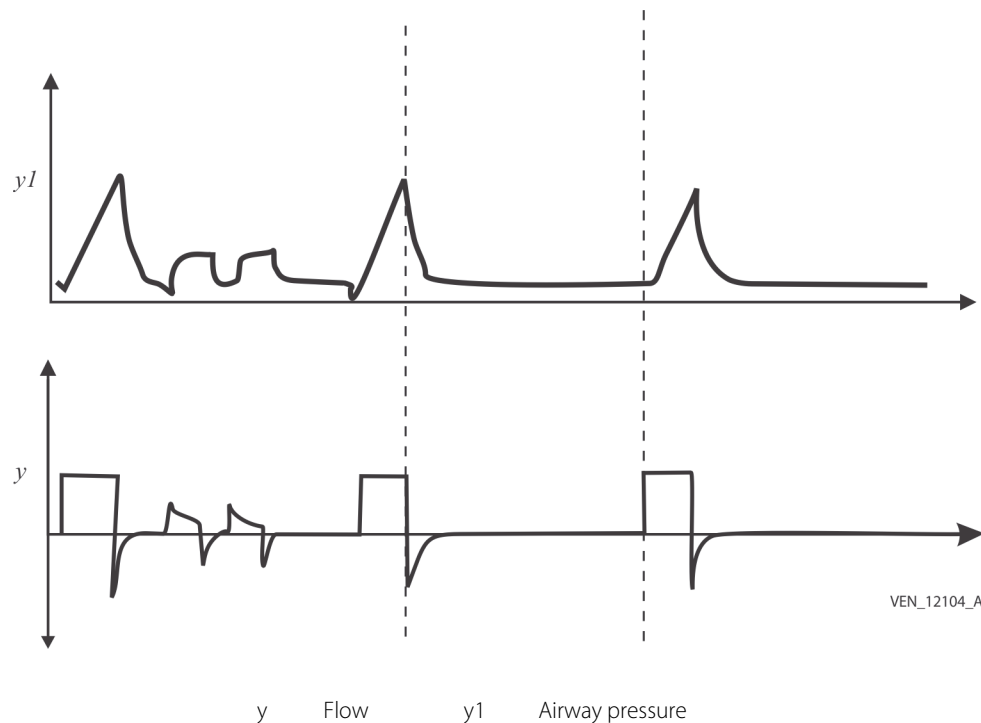
x	Time	y3	Volume
y1	Airway pressure	1	Start of inspiration
y2	Flow	2	End of inspiration

SIMV mode will also deliver pressure supported breaths (see the description for Pressure supported breaths). The SIMV mode is a combination of mandatory volume breaths and pressure supported breaths. The alternation between them is determined by the setting of breath rate (R-Rate) or period.

In addition, the back up rate will enable the ventilator to ventilate in the case of patient apnea. The back up rate is equal to the maximum between 8 and the breath rate (R-Rate). The “controlled” cycles following an apnea event will be volume cycles. These cycles end as soon as a new inspiration trigger is detected.

When the patient triggers a breathing effort, the volume and pressure cycles alternate between each other according to the breath rate setting (R-Rate). All the cycles are synchronized on inspiration triggers. A period always includes a volume cycle, plus as many pressure cycles as have been triggered by the patient; beyond the period the following inspiration trigger will initiate a new volume cycle, and so forth. See [Figure D-6](#).

**Figure D-6.** V SIMV Mode Breaths



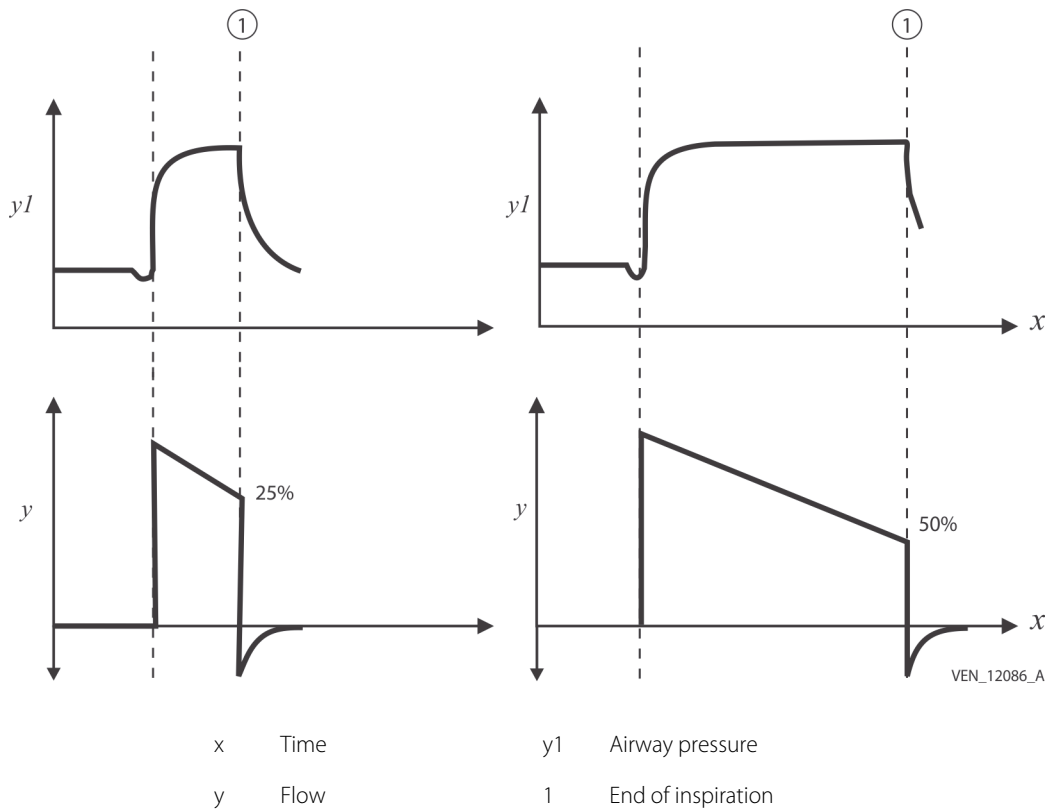
### D.2.4 Pressure Supported Breaths in SIMV and PSV Modes

In P SIMV (or Synchronized) and PSV modes, the supported breaths maintain the selected pressure (P Support). Inspiration is triggered by patient-generated flow. The inspiration is terminated when inspiratory flow drops to the Exhalation Sensitivity (E Sens) setting.

In P SIMV, additional mandatory pressure breaths will be delivered, dependent on the selected Breath Rate (Rate).

The shape of the pressure waveform depends on the setting of the pressure rise time (Rise Time). See [Figure D-7](#).

**Figure D-7.** Waveforms (Pressure Supported Breaths in SIMV and PSV Modes)

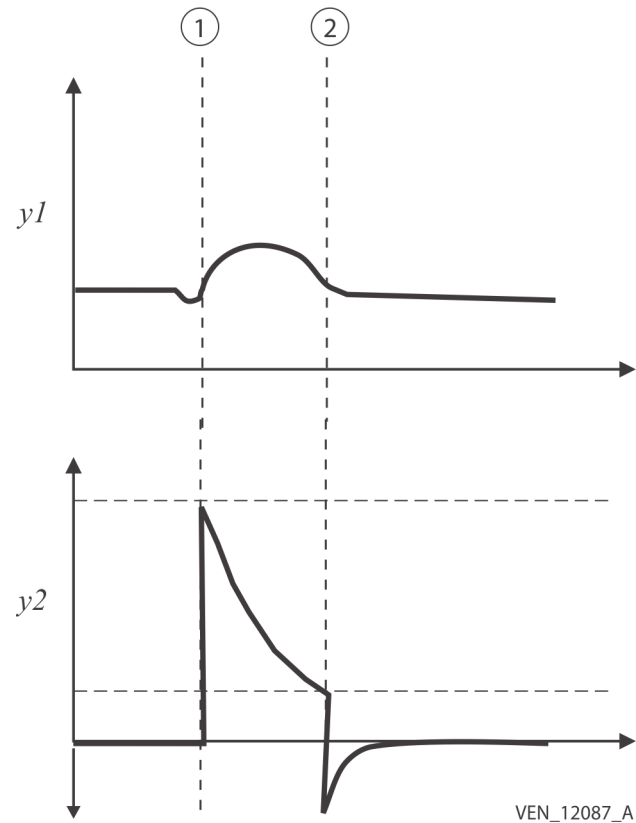




## D.2.5 CPAP

In Continuous Positive Airway Pressure (CPAP) the ventilator maintains pressure at the selected PEEP over the entire breath cycle. Inspiration is triggered by patient-generated flow. Inspiration is limited by the pressure and is cycled by the patient when inspiratory flow drops to the Exhalation Sensitivity threshold (E Sens = 25%). See [Figure D-8](#).

**Figure D-8.** Waveforms (CPAP)



y1	Airway pressure	1	Start of inspiration
y2	Flow	2	End of inspiration

## D.3 Ventilation Modes and Apnea

In SIMV mode with apnea time (Apnea Time) settings, the ventilator will sound an Apnea alarm if no patient effort occurs during the apnea time. During an Apnea alarm, the ventilator delivers breaths at a breath rate (backup rate) equal to the maximum of eight and the breath rate setting (R-Rate). If the patient initiates a spontaneous breath, the ventilator will stop the controlled breaths and return to the previous operating parameters.

In PSV mode, the back-up rate is activated so that the ventilator will automatically begin to deliver breaths at the breath rate (Backup R) setting if no patient effort occurs for the Apnea Time setting. The pressure during a back-up breath is equal to the Pressure Support (P Support) setting before the apnea condition began. If the patient initiates a spontaneous breath while the back-up rate is in effect, the ventilator will return to the previous operating parameters.

In CPAP, a backup rate is not set, but the operator must still set an apnea time (Apnea Time). In that case, the ventilator will sound an Apnea alarm if no breath is triggered by the patient in the apnea time; however, no back up breaths will be generated.

# E Operational Verification Checklist

The operational verification and safety checks listed in Table E-1 below should be performed to ensure the ventilator is operating properly in the following circumstances:

- Prior to using the ventilator with a patient
- Monthly while the ventilator is in use
- Following maintenance or changes in ventilator settings

If the ventilator fails any of the safety checks below, or if you cannot complete these checks, see section 5.9, *Troubleshooting* or call the equipment supplier or Covidien (see section 10.7, *Service Assistance*).



**WARNING:**


**Provide the patient with an alternate means of ventilation before conducting these tests.**



**WARNING:**

**To reduce the risk of infection, wash your hands thoroughly before and after handling the ventilator or its accessories.**

**Table E-1.** Operational Verification Checklist

1	Verify the proper appearance and cleanliness of the ventilator.	<input type="checkbox"/> Pass
2	Verify all of the labels and markings on the ventilator are clear and legible.	<input type="checkbox"/> Pass
3	Confirm the air inlet filter is clean and correctly installed.	<input type="checkbox"/> Pass
4	Ensure the AC power cable does not exhibit any signs of damage, such as kinks, breaks, or damaged insulation.	<input type="checkbox"/> Pass
5	Connect the AC power cable. Ensure that all power supply indicators on the front panel flash, except for the AC power supply (mains) indicator, which should remain lit.	<input type="checkbox"/> Pass
6	Push the I/O (power) switch to the I position to activate the ventilator test: Check that the two alarm indicators and the standby indicator (located close to the VENTILATOR ON/OFF  button) flash. Ensure also that the two alarm buzzers sound.	<input type="checkbox"/> Pass
7	Perform the functioning alarms tests. See Appendix F, <i>Alarms Tests</i> .	<input type="checkbox"/> Pass
8	Verify the alarm volume is adapted to the patient environment. See section 7.3, <i>Preferences Menu Parameters</i> for instructions on changing the alarm volume setting.	<input type="checkbox"/> Pass

**Table E-1.** Operational Verification Checklist (Continued)

9	Verify that the preventive maintenance schedule for the ventilator is followed. See Chapter <i>10, Routine Maintenance</i> .	<input type="checkbox"/> Pass
10	Ensure the patient breathing circuit is correctly attached to the ventilator, with all the necessary components, and is free from any signs of damage and leaks. If exhaled volume monitoring is required, use the double-limb circuit for exhaled tidal volume monitoring.	<input type="checkbox"/> Pass

# F Alarms Tests

Before connecting the ventilator to the patient, perform the following tests to ensure the ventilator's alarms are working properly.



**WARNING:**

**Do not perform ventilator alarm tests while the patient is connected to the ventilator. Provide the patient with an alternate means of ventilation before conducting these tests.**



**WARNING:**

**If the ventilator fails any alarm test or if you cannot complete these tests, see the Troubleshooting section (refer to Chapter 5, *Alarms and Troubleshooting*) of this manual or call your equipment supplier or Covidien (refer to section 10.7, *Service Assistance*).**



**WARNING:**

**The Min PIP alarm setting must be adjusted for the patient, but must also be set high enough to allow the Patient Disconnection alarm to trigger properly. Perform the low pressure test (see section F.1, *Low Pressure Test*) to ensure that the alarm is properly set.**




**WARNING:**

**The Max Leak alarm setting must be adjusted for the patient, but must also be set low enough to allow the High Leakage alarm to trigger properly. Perform the max leak test (see section F.2, *Max Leak Test (Only NIV)*) to ensure that the alarm is functioning properly. This alarm only applies to leak configuration (NIV).**



**Note:**

Many ventilator functions are not accessible when the Locking key  is enabled. See *Unlocking the Control Panel* on page 7-35 for instructions to disable the Locking key.



**Note:**

Most of these tests require that an approved patient circuit be connected to the ventilator. Ensure that your patient circuit is properly connected prior to performing these tests.

## F.1 Low Pressure Test



### WARNING:

The Min PIP alarm setting must be adjusted for the patient, but must also be set high enough to allow the Patient Disconnection alarm to trigger properly. Perform the following test to ensure that the alarm is properly set.



### Note:

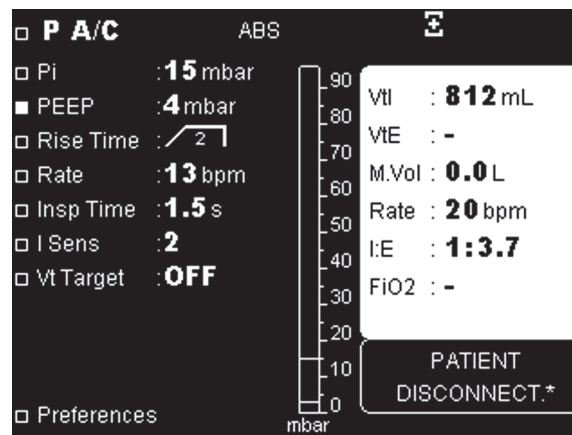
Before a low pressure test, the patient's clinician should have set ventilation and alarm parameters appropriately, and specified the circuit setup (single or dual).

### To perform a low pressure test, do the following:



1. Press the VENTILATION ON/OFF key to start ventilation.
2. Keep the patient's end of the breathing circuit open and allow ventilation to continue.
3. Wait for the Apnea time setting plus 2 seconds (Apnea time is not always 5 seconds), then ensure that:
  - The high priority indicator (flashing red LED) illuminates
  - The audible alarm sounds
  - The Patient Disconnection alarm is shown

Figure F-1. Ventilator Screen (Patient Disconnection alarm shown)



4. Press the ALARM CONTROL key once to pause the audible alarm.



5. Press and hold the VENTILATION ON/OFF key for 3 seconds, then release it. Press the VENTILATION ON/OFF key again to confirm stop.
  - The ventilator will switch to standby mode
  - Alarms are canceled

## F.2 Max Leak Test (Only NIV)



### WARNING:

The Max Leak alarm setting must be adjusted for the patient, but must also be set low enough to allow the High Leakage alarm to trigger properly. Perform the following test to ensure that the alarm is functioning properly. This alarm only applies to leak configuration (NIV).



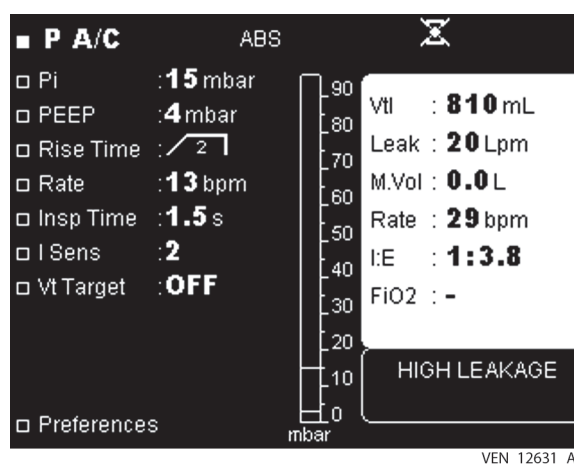
### Note:

Before performing the max leak test, a clinician should set ventilation and alarm parameters appropriately.

### To perform the max leak test:

1. Verify that the pressure tube of the patient circuit is properly connected to the appropriate fitting on both the ventilator and the proximal pressure port (see page 6-13).
2. Press the VENTILATION ON/OFF key to start ventilation.
3. Keep the patient's end of the breathing circuit open and allow ventilation to continue.
4. Allow the ventilator to deliver three consecutive breaths. At the beginning of the fourth breath, ensure that:
  - The high priority indicator (flashing red LED) illuminates
  - The audible alarm sounds
  - The High Leakage alarm is shown

Figure F-2. Ventilator Screen (High Leakage alarm shown)





### Note:

If the ventilator detects a Patient Disconnect alarm, the ventilator will not declare a High Leakage alarm.



5. Press the ALARM CONTROL key once to pause the audible alarm.

- 6.  Press and hold the VENTILATION ON/OFF key for 3 seconds, then release it.
- 7.  Press the VENTILATION ON/OFF key again to confirm stop.
  - Ventilation stops

### F.3 Circuit Check

Perform a circuit check whenever replacing or altering a patient circuit.  
 Ensure the patient is fully disconnected from the ventilator prior to starting this test.

#### F.3.1 Accessing the Circuit Check Screen



**Note:**

Before performing a circuit check, stop ventilation using the VENTILATION ON/OFF key, **not** the I/O (power) switch. If the I/O (power) switch was used to stop ventilation, the circuit check function cannot be used unless first stopping ventilation using the VENTILATION ON/OFF key.



**Note:**

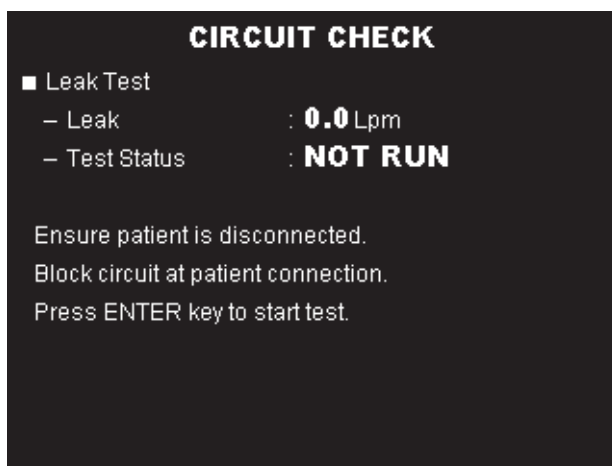
The circuit check screen cannot be accessed if the ventilator has been turned off without first being placed into standby. If unable to access the screen using this procedure, follow the normal procedure for turning the ventilator on, wait for it to enter standby mode, then follow the normal procedure for turning it off.

**To access the circuit check screen:**



1. Ensure that the ventilator’s I/O (power) switch is set to O (off).
2. Press and hold the MENU key, while turning the I/O (power) switch to I (on). Continue to hold down the MENU key until the circuit check screen appears (approximately 3 seconds).

**Figure F-3.** Circuit Check Screen (before starting)





## F.3.2 Performing the Circuit Check

### To perform a circuit check:

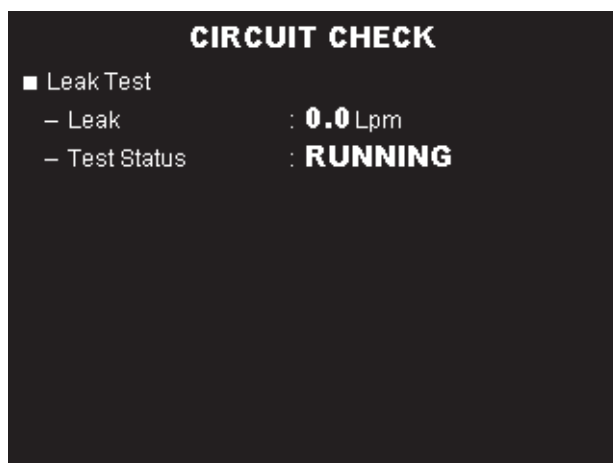
1. Verify that the proximal pressure tube of the patient circuit is properly connected to the proximal pressure port (see section 6.4, *Patient Circuit*).
2. Verify that the exhalation valve tube is connected to the exhalation valve port.
3. Block the patient connection port or patient wye of the patient circuit (see Figure F-4).

**Figure F-4.** Blocking the Patient Circuit (single-limb circuit at left; double-limb circuit at right)



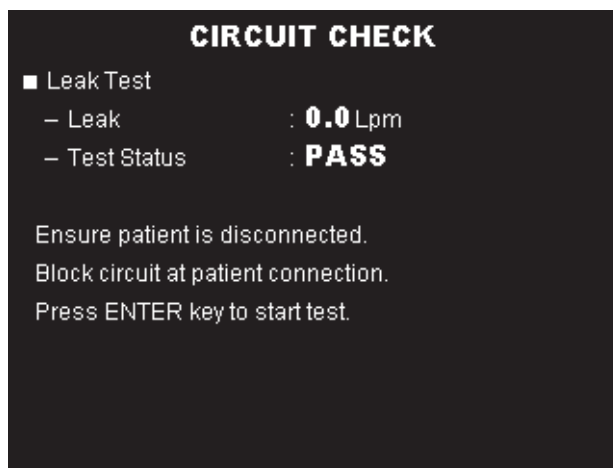
4. Activate the circuit check by pressing the ENTER key.
5. During the circuit check (which typically takes about 10 seconds to complete), the ventilator will do the following:
  - a. Sound a short beep
  - b. Close the exhalation valve
  - c. Show Test Status as RUNNING (see Figure F-5)

**Figure F-5.** Circuit Check (running)

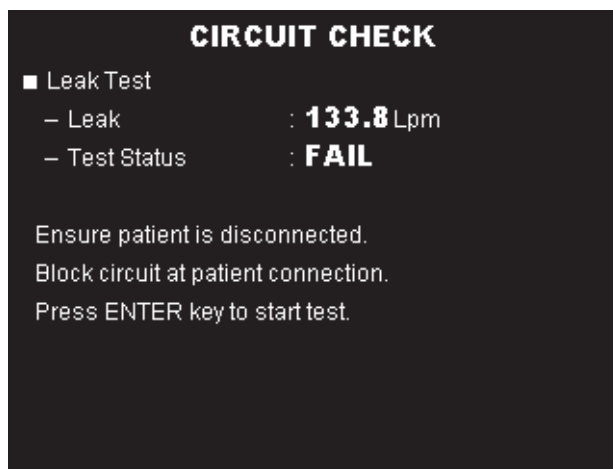


- d. Increase pressure to 30 mbar ( $\pm 10\%$  with no leak)
- e. Show flow sensor measurement as Leak in Lpm (updated every 2 seconds)
- f. Sound a short beep every time the flow measurement is updated
- g. Sound a long audible beep once the check is complete
- h. Show PASS (see Figure F-6) or FAIL (see Figure F-7) in the Test Status field

**Figure F-6.** Circuit Check (complete, passed)



**Figure F-7.** Circuit Check (complete, failed)



- 6. Review the results. A FAIL result indicates leak(s) of greater than 1 L/min exist.

✓ To rerun the circuit check, press the ENTER key again.

To cancel the circuit check while it is running, press the UP, DOWN, ENTER, VENTILATION ON/OFF, or MENU key.

### F.3.3 Troubleshooting a Failed Check

**If the circuit check fails, do the following:**

1. Ensure an approved circuit is in use. See [Table H-2](#).
2. Check patient circuit connections to the ventilator, examining each for leakage and tightness.
3. Replace the patient circuit if necessary.
4. Rerun the circuit check.
5. If the failure persists, have the ventilator evaluated by a qualified technician.

### F.3.4 Returning to Ventilation Mode

Once the circuit check is complete, cycle ventilator power to exit the test.

**To exit the circuit check screen and return to ventilation mode:**

1. Set the ventilator's I/O (power) switch to O (off).
2. Wait for 30 seconds.
3. Set the ventilator's I/O (power) switch to I (on).

The ventilator will proceed through its power-on routine, as described in section [7.1, Turning on the Ventilator](#), and then will be in standby mode.

## F.4 Apnea Test

Apnea breaths only apply in PSV, CPAP, and SIMV modes.

1. Connect the patient end of the patient circuit to a test lung.
2. Verify that the pressure tube of the patient circuit is properly connected to the appropriate fitting on both the ventilator and the proximal pressure port (see section [6.4, Patient Circuit](#)).



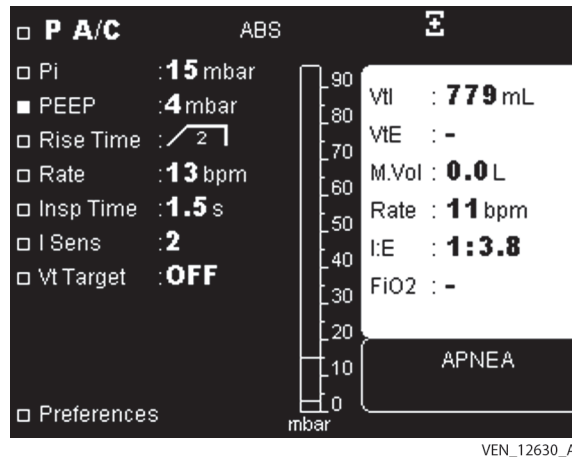
3. Press the VENTILATION ON/OFF key to start ventilation.

The ventilator will deliver a mandatory breath. Before the second mandatory breath is delivered, verify that the following events occur:

- The medium priority indicator (flashing yellow LED) illuminates
- An audible alarm sounds

- The Apnea alarm is shown

**Figure F-8.** Ventilator Screen (Apnea alarm shown)



4. Press the ALARM CONTROL key twice to reset the alarm.



5. Press and hold the VENTILATION ON/OFF key for 3 seconds, then release it. Press the VENTILATION ON/OFF key again to confirm stop.

- Ventilation stops

## F.5 Power Failure Test



### Note:

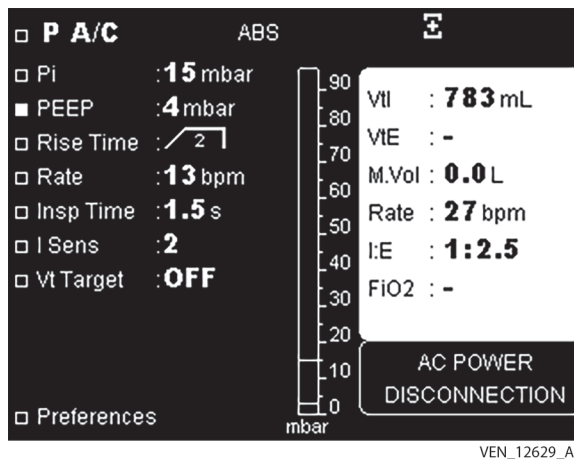
If the ventilator is operating on either the external power supply or the internal battery, you must plug it in to an AC power source before beginning this test.

### To perform a power failure test:

1. Disconnect the ventilator from its AC power supply. Ensure that the following events occur:
  - The low priority indicator (continuous yellow LED) illuminates
  - An audible alarm sounds
  - The DC power indicator illuminates if the DC power source is connected; otherwise, the internal battery indicator illuminates

- The AC Power Disconnection alarm is shown

**Figure F-9.** Ventilator Screen (AC Power Disconnection alarm shown)



2. Press the ALARM CONTROL key twice to reset the alarm.
3. Reconnect the ventilator to its AC power supply.

## F.6 Occlusion Test



### Note:

Occlusion testing can only be done in pressure modes.

### To perform an occlusion test:

1. Verify that the pressure tube of the patient circuit is properly connected to the appropriate fitting on both the ventilator and the proximal pressure port (see section 6.4, *Patient Circuit*).
2. Block the patient end or patient wye of the patient circuit. See *Figure F-10*.

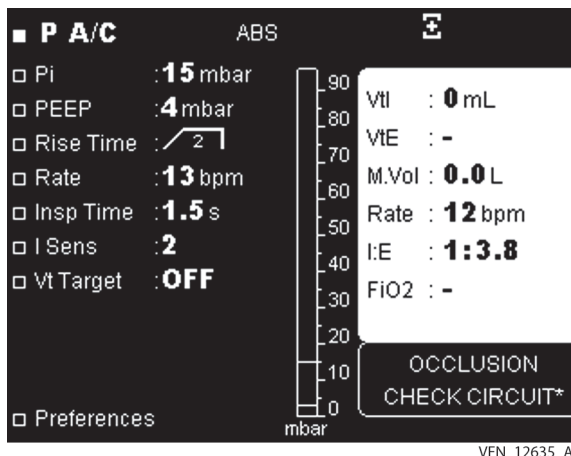
**Figure F-10.** Blocking the Patient Circuit (single-limb circuit at left; double-limb circuit at right)



VEN\_10209\_B

3. Press the VENTILATION ON/OFF key to start ventilation.
4. After two breaths or after 5 seconds, whichever takes longer, ensure that the following events occur:
  - The high priority indicator (flashing red LED) illuminates
  - An audible alarm sounds
  - The Occlusion alarm is shown; the Low VTI alarm may also activate

**Figure F-11.** Ventilator Screen (Occlusion alarm shown)



5. Press the ALARM CONTROL key once to pause the alarm.
6. Unblock the patient end or patient wye of the patient circuit, and connect the circuit to a test lung. (Connect the circuit quickly to avoid unnecessary triggering of the Patient Disconnect alarm.)
  - The Occlusion alarm is canceled
7. Press and hold the VENTILATION ON/OFF key for 3 seconds, then release it. Press the VENTILATION ON/OFF key again to confirm stop.
  - Ventilation stops

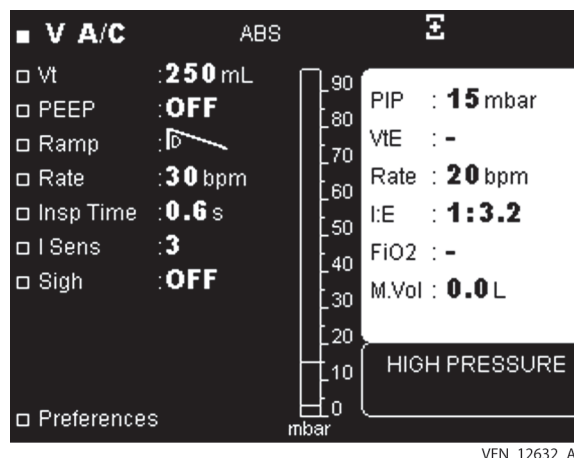
## F.7 High Pressure Test

### To perform a high pressure test:

1. Set the ventilator to V A/C mode and set the following parameter values:
  - Vt: 250 ml
  - PEEP: OFF
  - Flow Pattern: D
  - Rate: 30 bpm

- Insp Time: 0.6 s
  - I Sens: 3
  - Max PIP limit for High Pressure alarm: 12 mbar
  - Min PIP (Low Pressure) limit must be 4 or lower
2. Connect the patient end of the patient circuit to a test lung.
  3. Verify that the pressure tube of the patient circuit is properly connected to the appropriate fitting on both the ventilator and the proximal pressure port (see *Patient Circuit* on page 6-9).
4. Press the VENTILATION ON/OFF key to start ventilation.
5. Allow the ventilator to deliver three consecutive breaths. At the beginning of the fourth breath, ensure that:
    - The high priority indicator (flashing red LED) illuminates
    - An audible alarm sounds
    - The High Pressure alarm is shown


**Figure F-12.** Ventilator Screen (High Pressure alarm shown)



6. Press the ALARM CONTROL key once to pause the audible alarm.
  7. Set the High Pressure parameter value to 40 mbar.
    - The alarm is canceled
8. Press and hold the VENTILATION ON/OFF key for 3 seconds, then release it. Press the VENTILATION ON/OFF key again to confirm stop.
- Ventilation stops

## F.8 Continuous Positive Pressure Alarm Test

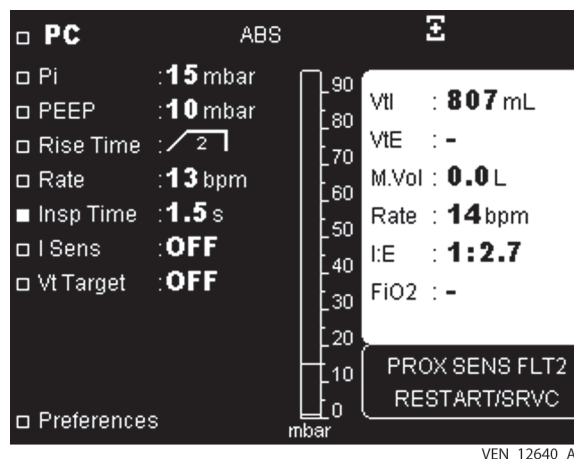
### To verify proper functioning of the Continuous Positive Pressure alarm:



1. Set the ventilator to P A/C mode and set the following parameter values:
  - Pi: 15 mbar
  - PEEP: 10 mbar
  - Rise Time: 2
  - Rate: 13 bpm
  - Insp Time: 1.5
  - Insp Sens: OFF
  - Vt Target: OFF
2. Connect the patient end or patient wye of the patient circuit to a test lung.
3. Connect a syringe to the connector of the proximal pressure port.
4. Set alarm disconnection to 17 seconds.
5. Set all alarms to OFF.
-  6. Press the VENTILATION ON/OFF key to start ventilation.
7. Use the syringe to create a constant pressure of 8.5 hPa to 11.5 hPa for at least 17 seconds. Ensure that:
  - The medium priority indicator (flashing yellow LED) illuminates
  - An audible alarm sounds



- The Proximal Sensor Fault 2 (PROX SENS FLT2) alarm is shown


**Figure F-13.** Ventilator Screen (Proximal Sensor Fault 2 alarm shown)



8. Use the syringe to create a constant pressure greater than 12 hPa for at least 17 seconds. Ensure that:
  - The medium priority indicator (flashing yellow LED) illuminates
  - An audible alarm sounds
  - The Proximity Sensor Fault 2 (PROX SENS FLT2) alarm activates (see Figure F-13)
9.  Press the ALARM CONTROL key twice to reset the alarm.
10.  Press and hold the VENTILATION ON/OFF key for 3 seconds, then release it. Press the VENTILATION ON/OFF key again to confirm stop.
  - Ventilation stops

## F.9 Delivered Volume Alarm Test

### To perform the delivered volume (Low VTI) test:

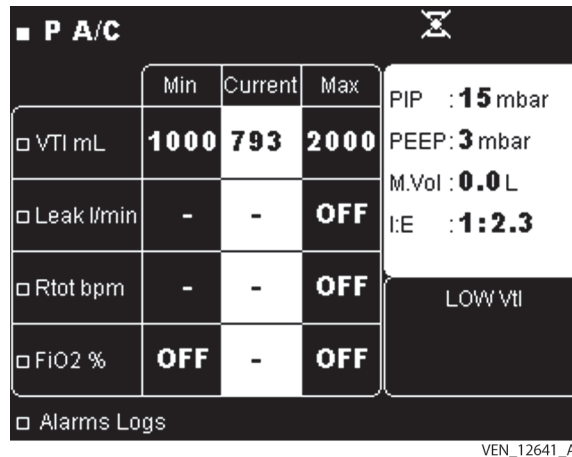
1. Connect the patient end of the patient circuit to a test lung.
2. Increase the lower VTI alarm limit to a value greater than the stabilized VTI being delivered, as shown on the ventilator screen.
3.  Press the VENTILATION ON/OFF key to start ventilation.

Allow a minimum of three breaths. Verify that the following events occur:

- The medium priority indicator (flashing yellow LED) illuminates
- An audible alarm sounds

- The Low VTI alarm is shown

**Figure F-14.** Ventilator Screen (Low VTI alarm shown)



4. Press the ALARM CONTROL key twice to reset the alarm.
5. Press and hold the VENTILATION ON/OFF key for 3 seconds, then release it. Press the VENTILATION ON/OFF key again to confirm stop.
  - Ventilation stops

## F.10 High Expiratory Volume Alarm Test

### To verify proper functioning of the high expiratory volume (High VTE) alarm:

1. Set the ventilator to P SIMV mode and set the following parameter values:

- Pi: 20 mbar
- P Support: 10 mbar
- PEEP: OFF
- Rise Time: 2
- Rate: 4 bpm
- Insp Time: 1.5 s
- Insp Sens: 1P
- E Sens: 75%
- Apnea Time: 10 s

2. Connect the patient end of the patient circuit to a test lung.

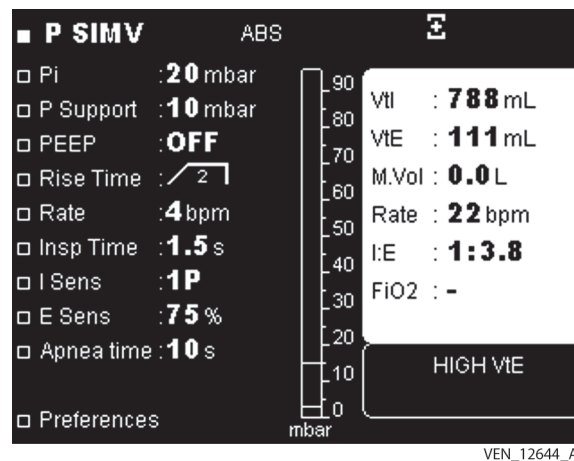
3. Press the VENTILATION ON/OFF key to start ventilation.

- Decrease the upper VTE alarm limit to a value less than the stabilized VTE being delivered, as shown on the ventilator screen.

Allow a minimum of three breaths. Verify that the following events occur:

- The medium priority indicator (flashing yellow LED) illuminates
- An audible alarm sounds
- The High VTE alarm is shown

**Figure F-15.** Ventilator Screen (High VTE alarm shown)




- Press the ALARM CONTROL key twice to reset the alarm.
- Press and hold the VENTILATION ON/OFF key for 3 seconds, then release it. Press the VENTILATION ON/OFF key again to confirm stop.
  - Ventilation stops

## F.11 Low Expiratory Volume Alarm Test

**To verify proper functioning of the low expiratory volume (Low VTE) alarm:**

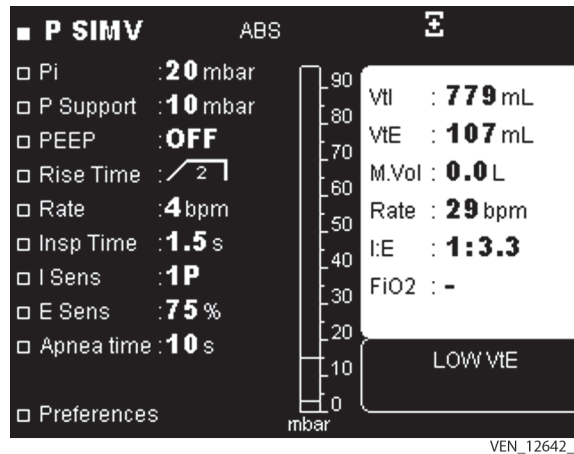
- Set the ventilator to P SIMV mode and set the following parameter values:
  - Pi: 20 mbar
  - P Support: 10
  - PEEP: OFF
  - Rise Time: 2
  - Rate: 4 bpm
  - Insp Time: 1.5



- I Sens: 1P
  - E Sens: 75%
  - Apnea Time: 10 s
2. Connect the patient end of the patient circuit to a test lung.
  3.  Press the VENTILATION ON/OFF key to start ventilation.
  4. Increase the lower VTE alarm limit to a value greater than the stabilized VTE being delivered, as shown on the ventilator screen.

Allow a minimum of three breaths. Verify that the following events occur:

- The medium priority indicator (flashing yellow LED) illuminates
- An audible alarm sounds
- The Low VTE alarm is shown

**Figure F-16.** Ventilator Screen (Low VTE alarm shown)



5.  Press the ALARM CONTROL key twice to reset the alarm.
6.  Press and hold the VENTILATION ON/OFF key for 3 seconds, then release it. Press the VENTILATION ON/OFF key again to confirm stop.
  - Ventilation stops

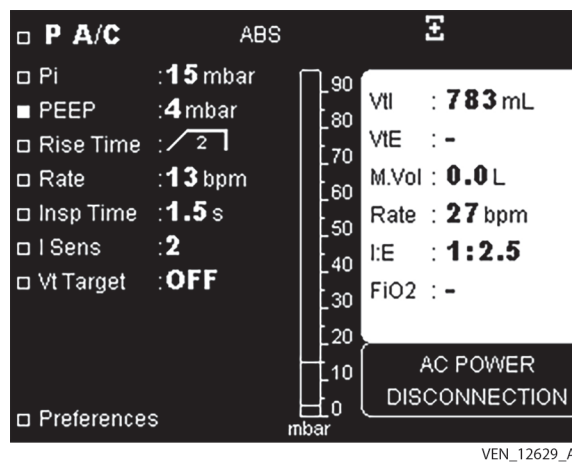
## F.12 Battery Test

The ventilator is capable of testing the power of the battery (see Chapter 8, *Internal Battery*). You can determine which power source the ventilator is using by checking the power indicator, located on the top panel. The indicator light will be lit to indicate which power source is currently available.

### To perform a battery test:

1. Disconnect the AC power supply cable (or the DC power cable, if it is connected) from the rear panel of the ventilator.
  - An AC Power Disconnection alarm will be shown

**Figure F-17.** Ventilator Screen (AC Power Disconnection alarm shown)



2. Press the ALARM CONTROL key twice to reset the alarm. Ensure that the following events occur:

- The internal battery indicator to the upper-left of the display illuminates
- The battery symbol is shown at the top of the screen (along with its reserve capacity)



3. Connect the AC (mains) power supply. Ensure that the following events occur:
  - The AC power indicator to the upper left of the display illuminates
  - The internal battery indicator to the upper-left of the display is flashing, which indicates that the battery is charging (this only occurs if the ventilator has run on battery power long enough to lose enough charge that the charger will turn on)
  - The battery symbol is no longer shown at the top of the screen

## F.13 Involuntary Stop Test

**To verify proper functioning of the very high priority audible alarm:**



1. Press the VENTILATION ON/OFF key to start ventilation.
2. Set the I/O (power) switch to the O (off) position to turn off the ventilator during ventilation. Ensure that the following events occur:
  - An audible alarm sounds continuously
  - The ventilator turns off; there should be no alarm indicators illuminated and no alarm messages shown



3. Press the ALARM CONTROL key once to cancel the audible alarm.

# G Unpacking and Preparation

The Puritan Bennett™ 560 ventilator is delivered with the items listed in [Table G-1](#).

**Table G-1.** Items Included with Ventilator

Item	Quantity
Printed user's manual <sup>1</sup>	1
Clinician's manual on CD <sup>2</sup>	1
Patient circuit and valve	1
Set of six combination foam/fine particle air inlet filters	1
Dual bag (carrying bag)	1
Oxygen connector	1
AC power cable	1

1. Language as requested by the customer.

2. A print copy is available upon request by the customer.



**WARNING:**

**Users must always possess an additional circuit and valve while using the Puritan Bennett™ 560 ventilator.**



**WARNING:**

**To minimize the risk of damage, you must use the dual bag to transport the Puritan Bennett™ 560 ventilator.**

**To unpack and prepare the ventilator:**

1. From the plastic bag, remove the following:
  - Plastic pocket containing the clinician's manual
  - The ventilator and its components and accessories
2. Remove the patient circuit, the AC ("mains") power cable, and the set of fine-particle air inlet filters.
3. Inspect the ventilator and ensure that:

- The ventilator's outer casing and the I/O (power) switch's protective cover do not have any dents or scratches, which may indicate possible damage
- The ventilator's labels and markings are clear and legible
- The AC power cable does not exhibit any signs of damage, such as kinks, breaks, or cuts



**WARNING:**

**Never use a ventilator or any components or accessories that appear to be damaged. If any signs of damage are evident, contact your equipment supplier or Covidien.**

4. Clean the ventilator with a mild soap solution, if necessary (see Chapter 9, *Cleaning*).
5. Ensure that the air inlet filter is installed.

If using the ventilator in the dual bag (worn as a backpack, or secured on a wheelchair or in a personal vehicle), see section 6.9, *Using the Dual Bag*. If mounting the ventilator on a utility cart, see section 6.10, *Mounting the Ventilator on a Utility Cart*.

To set up the patient circuit, see section 6.4, *Patient Circuit*.



# H Parts and Accessories

Table [H-1](#) provides a list of accessories that are available for the Puritan Bennett™ 560 ventilator. To order parts or accessories, contact your equipment supplier or Covidien representative. For a list of items delivered with the ventilator, see Appendix [G](#), *Unpacking and Preparation*.

**Table H-1.** List of Consumables and Accessories

Description
Carrying bag (grey)
Oxygen inlet connector
Ventilator cart
Dual bag (blue or pink), delivered with: <ul style="list-style-type: none"> <li>• Backpack padded straps, 2 each</li> <li>• Suspension belt</li> <li>• Carrying belt</li> </ul> <b>WARNING:</b> To minimize the risk of damage, you must use the ventilator's dual bag to transport the ventilator.
AC (mains) power cable
DC power cable (for connection to an external DC power source, such as a car 12 volt DC outlet)
Nurse call cable (5 meters)
Exhalation block, single-patient use (blue)
Air inlet combi-filter, fine (pack of 6) <b>Note:</b> This is the "foam plus fine particle" filter listed in Table <a href="#">10-1</a> on page <a href="#">10-8</a> .
Internal battery
External battery
FiO <sub>2</sub> measurement kit
FiO <sub>2</sub> sensor
2-way and 3-way DAR™ valves
<b>DAR™ inspiratory bacteria filters</b>
Electrostatic filter, large (formerly Barrierbac)
Electrostatic filter, small (formerly Barrierbac S)
Electrostatic filter; small, angled port (formerly Barrierbac S Angled)
Adult-pediatric electrostatic filter HME, large (formerly Hygrobac)

**Table H-1.** List of Consumables and Accessories (Continued)

Description
Adult-pediatric electrostatic filter HME, small (formerly Hygrobac S)
Adult-pediatric electrostatic filter HME, small, angled port (formerly Hygrobac S Angled)
Infant-pediatric electrostatic filter HME, small (formerly Hygroboy)
Adult-pediatric mechanical filter HME, large (formerly Hygroster)
Adult-pediatric mechanical filter HME, compact (formerly Hygroster Mini)
Mechanical filter, large (formerly Sterivent)
Mechanical filter, compact (formerly Sterivent S)
Mechanical filter, small (formerly Sterivent Mini)
Adult-pediatric HME (formerly Hygrolife II)

Table *H-2* provides a list of consumable parts available for the ventilator.



**WARNING:**

To ensure proper performance of the ventilator, use a patient circuit recommended by Covidien in this manual; see Chapter 6, *Installation and Assembly* and Appendix H, *Parts and Accessories*. The total specified length of the patient circuit tubing as measured from the ventilator outlet to the ventilator inlet is 1.1 meters (3.6 ft) to 2.0 meters (6.6 feet). The tubing must conform to all applicable standards and must be fitted with Ø 22 mm terminals that also conform to all applicable standards. Ensure that both the length and the internal volume of the patient circuit are appropriate for the tidal volume: a corrugated tube of Ø 22 mm for adult patients, and a corrugated tube of Ø 15 mm for pediatric patients with a tidal volume lower than 200 ml.

**Table H-2.** List of Circuits

Description	Part number
DAR™ double-limb patient circuit with exhalation valve, 180 cm, PVC, adult	5094000
DAR™ double-limb patient circuit with exhalation valve, 180 cm, PVC, pediatric	5093900
DAR™ single-limb patient circuit with exhalation valve, 180 cm, PVC, adult	5093600
DAR™ single-limb patient circuit with exhalation valve, 180 cm, PVC, pediatric	5093500
DAR™ single-limb patient circuit without exhalation valve, 180 cm, PVC, adult	5093300
DAR™ single-limb patient circuit without exhalation valve, 180 cm, PVC, pediatric	5093100



**Note:**

The responsible organization is accountable for the compatibility of the ventilator and all of the parts and accessories used to connect to the patient before use.

For more information regarding parts and accessories for the Puritan Bennett™ 560 ventilator, contact your service representative or [www.covidien.com/rms/products](http://www.covidien.com/rms/products).

# I Glossary

## **AC Power**

Alternating current.



## **Alarm Pause**

The audible and visual alarms cease and the alarm paused symbol appears. The symbol will remain until the cause of the alarm is addressed. For example, when the ventilator is running on internal battery, the AC Disconnection alarm may be paused, and the alarm paused symbol will appear until the device is plugged into AC. The paused alarm will be captured in the alarm log screen and can be reactivated.

## **Alarm Reset**

Used only for the High Pressure alarm, this function resets the visual alarm message.

## **Apnea**

The absence of breathing or a breathing pattern capable of supporting an individual's respiratory needs.

## **Apnea Index (AI)**

The apnea index is the average number of apnea events per hour of ventilation. It is based on the Apnea alarm.

## **Apnea Time**

Time allowed between breath starts before Apnea alarm occurs when no patient effort is detected.

## **Assist/Control**

In Assist/Control mode, the ventilator delivers an assisted breath of a set volume or set pressure when the patient's breathing effort creates a flow or pressure drop that is greater than the sensitivity setting. In absence of patient breathing effort, the ventilator will deliver a controlled breath of the set volume or pressure. (Does not apply in PSV/CPAP mode).

## **Assisted Breath**

A volume or pressure breath triggered by the patient but then controlled and terminated by the ventilator.



## **Audio Pause**

Pauses the audible alarm for 60 seconds at a time and shows the audio paused symbol.

**Back Up Rate**

Rate of control cycles in PSV or SIMV modes during apnea phase.

**Battery Level**

Display of the remaining battery capacity; located adjacent to the battery symbol.

**Bias Flow**

Turbine flow during exhalation phase through the patient circuit to avoid rebreathing.

**bpm**

An abbreviation for “breaths per minute,” which is the unit of measure for breath rate (see below).

**Breath Rate**

The total number of breaths, both machine and spontaneous, delivered by a ventilator in one minute.

**Caregiver**

An individual who assists a patient with the tasks of daily living. This may be a family member, a live-in assistant, or the nursing staff of a health care facility.

**cmH<sub>2</sub>O**

An abbreviation for “centimeters of water,” which is a unit of measure for pressure.

**CPAP (Continuous Positive Airway Pressure)**

Continuous airway pressure maintained throughout a spontaneous breath cycle.

**Controlled Breath**

A volume or pressure breath triggered, controlled and terminated by the ventilator.

**DC Power**

Direct current.

**Double-Limb Patient Circuit**

Patient circuit with a tube between the ventilator gas outlet and the patient for inspiratory gas and another tube between the patient and the exhalation block for exhalation gas.

**Exhalation Block**

Part of the ventilator that allows the connection of the exhalation limb of the patient circuit. The exhalation block is for single-patient use only.

**Exhalation Phase**

Phase of the breath cycle during which the patient exhales.

**Exhalation Sensitivity**

The exhalation sensitivity (E Sens) level is a percentage of peak flow at which a pressure-supported breath will be terminated.

---

**Exhalation Tidal Volume (VTE)**

Volume exhaled by the patient at each exhalation phase.

**Exhaled Tidal Volume (VTE)**

Exhaled volume measured for all breath types through the exhalation block. Monitored value available only with double-limb patient circuit. Exhaled volume is computed using a five-breath average.

**Fraction of Inspired Oxygen (FiO<sub>2</sub>)**

Amount of oxygen delivered to the patient.

**FiO<sub>2</sub> Sensor**

The sensor that measures the amount of oxygen being delivered to the patient.

**Flow**

Volume of gas delivered by the ventilator compared to time, expressed in liters per minute (lpm).

**Flow Pattern (Ramp Setting)**

This is the flow distribution shape during the inspiration phase. There are three flow patterns available: Square waveform or constant flow, Decelerated (sawtooth waveform) or decreasing flow and Sinusoidal flow.

**Freeze**

Interruption of the waveform plot tracing on the ventilator's display.

**hPa**

An abbreviation for "hectopascal", which is a unit of measure for atmospheric pressure.

**I:E Ratio**

Inspiratory time versus exhalation time ratio.

**Inspiratory Phase**

Phase of the breath cycle during which the patient inspires.

**Inspiratory Pressure (Pi)**

The operator-set inspiratory pressure during a pressure control (PC) mandatory breath.

**Inspiratory Sensitivity (I Sens)**

Level of inspiratory effort the patient has to provide during the initiation of a machine breath. The sensitivity levels (from 0P to 5) correspond to differences in flow compared to the bias flow. Level 0P is the most sensitive (for a pediatric use) and requires the least effort to trigger a breath. Level 5 requires the most amount of effort to trigger a breath.

**Inspiratory Tidal Volume (VTI)**

Volume delivered to the patient at each inspiratory phase.

**I Time (Inspiratory Time)**

Inspiratory time measure.

**Intentional Vent Stop Alarm**

Ventilation has been switched off by the user/caregiver and the ventilator is in standby.

**I/T Ratio**

Inspiratory time versus total breath time ratio.

**L**

Liters (a unit of volume).

**Leak**

When ventilating with a double-limb circuit in leak configuration, it is the average unexpected leak during each cycle and over the past 24-hour period. When ventilating with a single-limb circuit there is no average leak.

**LED**

Light emitting diode; used as indicator lights on the ventilator's front panel.

**lpm**

Liters per minute (a unit of volume flow rate).

**Machine Hours**

Counter for the total ventilation time since manufacture or the last CPU board change.

**Mains**

AC power supply.

**Max Leak**

The maximum alarm setting of a high leakage threshold. An alarm will be triggered in the event the calculated leakage flow exceeds this limit.

**Max Rtot (Total Breath Rate)**

The maximum alarm setting to prevent hyperventilation or ventilator autotriggering. The High Rate alarm will be triggered if the total breath rate exceeds the maximum limit set.

**Max P (Maximum Inspiration Pressure)**

Max P allows the ventilator to adjust the inspiratory pressure up to a maximum limit in order to reach the target tidal volume (Vt Target).

**mbar**

An abbreviation for "millibar", which is a unit of measure for atmospheric pressure.

**Mean Airway Pressure**

Average patient pressure during each breath.

**Minimum Exhalation Time**

Minimum exhalation time before allowing the patient inspiratory trigger.

---

### **Minimum Inspiratory Time**

Minimum inspiratory time before allowing the patient to exhale.

### **M Vol (Minute Volume)**

Flow delivered at each breath to the patient is measured by the inspiratory flow sensor and that measurement is used to calculate minute volume ( $V_t \times R_{tot}$ ).

### **Non-Invasive Ventilation (NIV)**

Patient ventilation without the use of an endotracheal tube; instead using interfaces such as masks, nasal prongs, or uncuffed endotracheal tubes. NIV is also known as leak configuration.

### **P A/C (Pressure Assist/Control)**

A ventilator mode which provides machine-initiated breaths delivered at a clinician-set pressure, inspiratory time, and rate.

### **Patient Breath**

Breathing cycle initiated by the patient.

### **Patient Circuit**

Tubing between the ventilator and the patient.

### **Patient Counter**

Counter of ventilation time for the patient.

### **Patient Effort**

Inspiratory effort initiated by the patient.

### **Pause**

Waveforms freezing function.

### **Paw (Peak Airway Pressure)**

The Peak Airway Pressure is the average peak pressure during the inspiratory phase, measured by each cycle and over the previous 24-hour period.

### **Peak Inspiratory Pressure (PIP)**

The highest pressure measured in the patient circuit during the inspiration phase.

### **Positive End Expiratory Pressure (PEEP)**

Pressure in the patient circuit at the end of expiration.

### **Pressure Control (P Control)**

Augmentation of the patient's ventilation synchronously with inspiratory effort until a preset pressure is met. Pressure is maintained throughout patient inspiratory flow, and is cycled to expiration by time (controlled by the selected Inspiratory Time setting). Used in Assist/Control mode.

**Pressure Support (P Support)**

Augmentation of the patient's ventilation synchronously with inspiratory effort until a preset pressure is met. Pressure is maintained until inspiratory flow is reduced to a percentage of peak flow that depends on the exhalation sensitivity setting for the inspiration, when the ventilator cycles into exhalation. Available in SIMV mode.

**PSI**

Pounds per square inch.

**PSV (Pressure Support Ventilation)**

Pressure support ventilation.

**Rebreathing**

The patient breathes his/her exhaled gas.

**Respiratory Rate**

The number of breath cycles (inspiration + expiration) completed within one minute. Normal resting adult respiratory rates are from 12–20 breaths per minute (bpm).

**Rise Time**

This determines how the target pressure will be reached, and indirectly defines the minimum inspiration time.

**Rtot**

Parameter measured by the ventilator equal to the total number of breaths per minute (bpm).

**Sigh**

A sigh is an increased volume of gas delivered to the patient at a set rate (for example, every 50 breaths).

**Spont Cyc (Spontaneous Cycling)**

This is the percentage of ventilation cycles initiated by the patient over the previous 24-hour period.

**Standby**

The operational mode of the ventilator where it is powered (I/O (power) switch set to the I position), but is not ventilating the patient.

**SIMV (Synchronized Intermittent Mandatory Ventilation)**

A ventilator mode which provides a mechanism for synchronizing the ventilator-delivered breaths with a patient's inspiration, as detected by the ventilator.

**Tidal Volume (Vt)**

Volume of gas delivered to the patient in a breath.

**Unfreeze**

Resumption of the waveform plot tracing on the ventilator's display.



---

**V A/C (Volume Assist/Control)**

A ventilator mode which provides machine-initiated breaths are delivered at a clinician-set volume inspiratory time, and rate.

**Vent Time (Ventilation Time)**

The ventilation duration data is based on the patient counter and shows the total ventilation time in hours and minutes over the previous 24-hour period.

**Volume Breath**

Inspiration of the selected volume, delivered over the selected inspiratory time.

Page Left Intentionally Blank

---

# Index

## A

- AC power
  - Connecting ..... 6-3
  - Disconnecting ..... 6-6
- AC Power Disconnection alarm
  - Cause & response ..... 5-9
  - Corrective action ..... 5-15
- Air circulation (warning) ..... 1-6, 6-2
- Air inlet filter ..... 6-17
  - Replacing ..... 10-6
- Air transport
  - Battery warning ..... 2-1, 8-1
  - Carry-on baggage rules and requirements (warning) ..... 2-1, 8-1
  - Use on commercial aircraft ..... 2-1
- Air transportation standards compliance ..... B-15
- Alarm Logs menu
  - Access ..... 5-4
  - Dismissing
    - Automatically ..... 5-5
    - Manually ..... 5-5
- Alarm messages
  - AC POWER DISCONNECTION ..... 5-9, 5-15
  - APNEA ..... 5-9, 5-16
  - BATTERY FAULT1 ..... 5-9, 5-16, 8-5
  - BATTERY FAULT2 ..... 5-9, 5-16
  - BUZZER FAULT1 ..... 5-9, 5-16
  - BUZZER FAULT2 ..... 5-9, 5-16
  - BUZZER FAULT3 ..... 5-9, 5-16
  - BUZZER LOW BATTERY ..... 5-9, 5-16
  - CALIBRATE FIO<sub>2</sub> ..... 5-9, 5-16
  - CALIBRATION FAIL ..... 5-10, 5-17
  - CHECK BATTERY CHARGE ..... 5-10, 5-17
  - CHECK EXH VALVE ..... 5-10, 5-17
  - CHECK EXH VALVE PRESSURE ..... 5-10, 5-17
  - CHECK FIO<sub>2</sub> SENSOR ..... 5-10, 5-17
  - CHECK PROXIMAL LINE1 ..... 5-10, 5-17
  - CHECK REMOTE ALARM ..... 5-10, 5-18
  - CHECK SETTINGS ..... 5-10, 5-18
  - CONNECT VALVE OR CHANGE PRESS ..... 5-10, 5-18
  - CONTROLLED CYCLES ..... 5-11, 5-18
  - COOLING FAN ..... 5-11, 5-18
  - DC POWER DISCONNECTION ..... 5-11, 5-18, 6-8
  - DEVICE FAULT10 ..... 5-11, 5-18
  - DEVICE FAULT11 ..... 5-11, 5-18
  - DEVICE FAULT12 ..... 5-11, 5-18
  - DEVICE FAULT13 ..... 5-11, 5-19
  - DEVICE FAULT3 ..... 5-11, 5-18
  - DEVICE FAULT5 ..... 5-11, 5-18
  - DEVICE FAULT7 ..... 5-11, 5-18
  - DEVICE FAULT9 ..... 5-11, 5-18
  - E SENS FAULT OR CIRC LEAK ..... 5-11, 5-19
  - EMPTY BATTERY ..... 5-11, 5-19, 8-4
  - EXH VALVE LEAKAGE ..... 5-11, 5-19
  - FIO<sub>2</sub> SENSOR MISSING ..... 5-11, 5-19
  - HIGH FIO<sub>2</sub> ..... 5-12, 5-19
  - HIGH INT TEMP COOL VENT ..... 5-20
  - HIGH LEAKAGE ..... 5-12, 5-20
  - HIGH PRESSURE ..... 5-12, 5-21
  - HIGH RATE ..... 5-12, 5-21
  - HIGH VTE ..... 5-12, 5-21
  - HIGH VTI ..... 5-12, 5-22
  - HIGH/LOW BATTERY TEMP ..... 5-11, 5-12, 5-20
  - INSP FLOW ..... 5-12, 5-22
  - INTENTIONAL VENT STOP ..... 5-12, 5-22
  - KEYPAD FAULT ..... 5-12, 5-22
  - LOW BATTERY ..... 1-8, 5-12, 5-22, 8-4
  - LOW FIO<sub>2</sub> ..... 5-13, 5-22
  - LOW VTE ..... 5-13, 5-23
  - LOW VTI ..... 5-13, 5-23
  - OCCLUSSION CHECK CIRCUIT
    - In leak configuration ..... 5-13, 5-23
    - In valve configuration ..... 5-13, 5-23
  - PATIENT DISCONNECTION ..... 5-13, 5-24
  - POWER FAULT ..... 5-13, 5-24
  - POWER SUPPLY LOSS ..... 5-14, 5-24
  - PRES SENS FLT1 ..... 5-14, 5-24
  - PROX SENS FLT2 ..... 5-14, 5-24
  - REMOVE VALVE CPAP MODE ..... 5-14, 5-24
  - REMOVE VALVE OR CHANGE PRES ..... 5-14, 5-24
  - SOFTWARE VERSION ERROR ..... 5-14, 5-24
  - TURB OVERHEAT ..... 5-14, 5-24
  - UNKNOWN BATTERY ..... 5-14, 5-24
  - VALVE MISSING CONNECT VALVE ..... 5-14, 5-25
  - VTI NOT REACHED ..... 5-14, 5-25
- Alarm parameters
  - Blocking alarm thresholds ..... 7-29
  - P A/C Mode Menu ..... 3-13
  - P SIMV Mode Menu ..... 3-22
  - Setting ..... 7-27
  - V SIMV Mode Menu ..... 3-28
- Alarm tone (setting) ..... 7-7
- Alarms
  - Alarm Logs menu ..... 5-4
  - Alarm menu ..... 2-8
  - Apnea alarm setting ..... 7-19
  - Blocking alarm thresholds ..... 7-29
  - Calibration Fail ..... 10-4
  - Disconnection alarm setting ..... 7-20
  - Display ..... 5-2
  - Intentional Ventilation Stop alarm setting ..... 7-7
  - Level of priority ..... 5-2
  - NO DATA message ..... 5-4
  - Overview of alarms ..... 5-9
  - Pausing ..... 5-6
    - Audible portion ..... 5-5
  - Reactivating ..... 5-7
  - Resetting ..... 5-7
  - Setting alarm volume ..... 7-18
  - Setting parameters ..... 7-27
  - Technical faults ..... 5-1
- Tests
  - Apnea test ..... F-7
  - Battery test ..... F-17
  - Circuit check ..... F-4
  - Continuous positive pressure alarm ..... F-12
  - Delivered volume alarm ..... F-13
  - High expiratory volume alarm ..... F-14
  - High pressure ..... F-10
  - Involuntary stop test ..... F-18
  - Low expiratory volume alarm ..... F-15
  - Low pressure ..... F-2
  - Max leak test ..... F-3
  - Occlusion ..... F-9
  - Power failure ..... F-8

---

# Index

Troubleshooting	5-15
Ventilation (utilization)	5-1
Altitude compensation feature	C-2
Anesthetic gases (contraindication)	2-2
Apnea (hypoventilation) alarm	
Cause & response	5-9
Corrective action	5-16
Apnea alarm (setting)	7-19
Apnea alarm test	F-7
Apnea and Backup Rate	3-29, 3-30
Apnea time	
In CPAP mode	3-10
In P SIMV mode	3-24
In PSV mode	3-6
In V SIMV mode	3-30
Assist/Control (A/C) modes (description)	D-1
Audible alarms, pausing	5-5
<b>B</b>	
Back (Setup 2 menu)	7-14
Back panel	2-5
Backlight (setting)	7-16
Backpack use	6-27
Backup R (backup rate)	3-5
Backup Rate and R-Rate setting	3-28, 3-29, 3-30
Bacteria filter	6-18
Bar chart, pressure	4-1
Bargraph display	4-7
Battery	
Capacity	8-2
Maintenance	10-10
Operation	8-3
Recharging	8-5
Replacement	10-10
Reserve capacity display	
Ventilation running	8-4
Ventilation stopped	8-3
Storage	8-6
Testing	8-5, 10-10, F-17
Battery Fault 1 alarm	
Cause & response	5-9, 8-5
Corrective action	5-16
Battery Fault 2 alarm	
Cause & response	5-9
Corrective action	5-16
Battery, internal	
Charging (warning)	6-2
Heat safety device	1-7
Breath types	
CPAP	D-9
Pressure control breaths (A/C modes)	D-4
Pressure supported breaths (SIMV and PSV modes)	D-8
Volume breaths (A/C modes)	D-2
Volume breaths (V SIMV modes)	D-5
Breathing circuit	2-3
Buzzer Fault 1 alarm	
Cause & response	5-9
Corrective action	5-16
Buzzer Fault 2 alarm	
Cause & response	5-9
Corrective action	5-16

Buzzer Fault 3 alarm	
Cause & response	5-9
Corrective action	5-16
Buzzer Low Battery alarm	
Cause & response	5-9
Corrective action	5-16
<b>C</b>	
Calibrate FiO <sub>2</sub> alarm	
Cause & response	5-9
Corrective action	5-16
Calibration	
Exhalation flow sensor	10-2
FiO <sub>2</sub> sensor	10-4
Calibration Fail alarm	10-4
Cause & response	5-10
Corrective action	5-17
Capacity of the battery	8-2
Carbon dioxide	
Risk of inhalation and suffocation (warning)	1-2, 7-37
Cautions (definition)	1-1
Check Battery Charge alarm	
Cause & response	5-10
Corrective action	5-17
Check Exhalation Valve alarm	
Cause & response	5-10
Corrective action	5-17
Check Exhalation Valve Pressure alarm	
Cause & response	5-10
Corrective action	5-17
Check FiO <sub>2</sub> Sensor alarm	
Cause & response	5-10
Corrective action	5-17
Check Proximal Line 1 (continuous positive pressure) alarm	
Cause & response	5-10
Corrective action	5-17
Check Remote Alarm alarm	
Cause & response	5-10
Corrective action	5-18
Check Settings alarm	
Cause & response	5-10
Corrective action	5-18
Circuit check	
Accessing the Circuit Check screen	F-4
Performing the circuit check	F-5
Returning to ventilation mode	F-7
Troubleshooting a failed check	F-7
Classification of device	2-3
Cleaning	
Accessories	9-2
Approved solutions	9-2
Exhalation block	9-2
Pneumatic system description	9-3
Ventilator	9-1
Collateral standards compliance	B-14
Connect Valve or Change Pressure alarm	
Cause & response	5-10
Corrective action	5-18
Connecting	
AC power	6-3
DC power	6-6

# Index

FiO <sub>2</sub> sensor	6-25
Nurse call cable	6-32
Oxygen supply	6-22
Patient circuit	6-9, 6-10
Continuous positive pressure alarm test	F-12
Contraindications	2-2
Contrast (setting)	7-17
Control panel	2-6
Locking	7-35
Unlocking	7-35
Controlled Cycles message	
Cause & response	5-11
Corrective action	5-18
Cooling Fan alarm	
Cause & response	5-11
Corrective action	5-18
CPAP (Continuous Positive Airway Pressure) mode	
Apnea time	3-10
E Sens (exhalation sensitivity)	3-11
I Sens (inspiratory trigger sensitivity)	3-11
Max FiO <sub>2</sub> (maximum fraction of inspired oxygen)	3-11
Max Leak (maximum leakage)	3-10
Max Rtot (maximum total breath rate)	3-11
Max VTI (maximum inspiratory tidal volume)	3-10
Min FiO <sub>2</sub> (minimum fraction of inspired oxygen)	3-11
Min VTI (minimum inspiratory tidal volume)	3-10
Parameters	
Alarm	3-9
Ventilation	3-9
PEEP (positive end expiratory pressure)	3-10
CPAP (Continuous Positive Airway Pressure) mode (description)	D-2
CPAP breaths (description)	D-9
CPAP mode and ventilator-dependent patients (warning)	3-9
Cycling mode (setting)	7-12
<b>D</b>	
Date (setting)	7-7
DC power	
Connecting	6-6
DC Power Disconnection alarm	
Cause & response	5-11
Corrective action	5-18
Delivered volume alarm test	F-13
Device classification	2-3
Device Fault 10 alarm	
Cause & response	5-11
Corrective action	5-18
Device Fault 11 alarm	
Cause & response	5-11
Corrective action	5-18
Device Fault 12 alarm	
Cause & response	5-11
Corrective action	5-18
Device Fault 13 alarm	
Cause & response	5-11
Corrective action	5-19
Device Fault 3 alarm	
Cause & response	5-11
Corrective action	5-18
Device Fault 5 alarm	
Cause & response	5-11
Corrective action	5-18
Device Fault 7 alarm	
Cause & response	5-11
Corrective action	5-18
Device Fault 9 alarm	
Cause & response	5-11
Corrective action	5-18
Digital monitoring	
Inspiratory trigger	4-5
Menus	4-1
Monitored parameters shown	4-6
Disconnecting	
AC power cable	6-6
DC power cable	6-8
Disconnection alarm (setting)	7-20
Double-limb patient circuit	
Installing	6-13
Dual bag	
Fitting ventilator into	6-26
Securing in personal vehicle	6-29
Securing on wheelchair	6-27
Wearing as backpack	6-27
<b>E</b>	
E Sens (exhalation sensitivity)	
In CPAP mode	3-11
In P SIMV mode	3-25
In PSV mode	3-5
In V SIMV mode	3-31
E Sens (exhalation sensitivity) (setting)	7-13
E Sens Fault or Circuit Leak alarm	
Cause & response	5-11
Corrective action	5-19
Electrical specifications	B-1
Electromagnetic compatibility	
Emissions and use of accessories (warning)	6-2
Mobile/portable communications equipment (warning)	6-3
Empty Battery alarm	
Cause & response	5-11
Corrective action	5-19
Empty Battery alarm message	8-4
Environmental specifications	B-9
Erase data from USB memory device	7-34
Exhalation block	
Cleaning	9-2
Installing	6-20
Removing	6-20
Exhalation flow sensor calibration	10-2
Exhalation Valve Leakage alarm	
Cause & response	5-11
Corrective action	5-19
Expected service life	10-1
<b>F</b>	
FAA (United States Federal Aviation Administration) requirements	2-1
Filters	
Air inlet filter	6-17
Bacteria	6-18
FiO <sub>2</sub> for oxygen and ventilator settings	3-34
FiO <sub>2</sub> sensor (connecting)	6-25
FiO <sub>2</sub> sensor calibration	10-4

---

# Index

FiO <sub>2</sub> Sensor Missing alarm	
Cause & response	5-11
Corrective action	5-19
Freezing a waveform trace	4-8
Front panel	2-4

## G

General standards compliance	B-14
Glossary	I-1

## H

Heat safety device, battery	1-7
High expiratory volume alarm test	F-14
High FiO <sub>2</sub> alarm	
Cause & response	5-12
Corrective action	5-19
High Internal Temperature alarm	
Corrective action	5-20
High Leakage alarm	
Cause & response	5-12
Corrective action	5-20
High pressure (alarm) test	F-10
High Pressure alarm	
Cause & response	5-12
Corrective action	5-21
High priority (HP) alarm (definition)	5-2
High Rate alarm	
Cause & response	5-12
Corrective action	5-21
High VTE alarm	
Cause & response	5-12
Corrective action	5-21
High VTI alarm	
Cause & response	5-12
Corrective action	5-22
High/Low Battery Temperature alarm	
Cause & response	5-11, 5-12
Corrective action	5-20
Holes, air circulation	1-6, 6-2
Hours counters (machine and patient)	7-3
Humidifier	6-18

## I

I Sens (inspiratory trigger sensitivity)	
In CPAP mode	3-11
In P A/C mode	3-15
In P SIMV mode	3-24
In PSV mode	3-4
In V A/C mode	3-19
In V SIMV mode	3-30
Ignition sources (warning)	6-2
Indications for use	
General	2-1
Target environments	2-1
Target operators	2-2
Target patients	2-1
Indicator and alarm specifications	B-3
Indicators	
AC power	8-5
Internal battery	8-3, 8-5
Ventilator standby	7-3

Insp Time (inspiratory time)	
In P A/C mode	3-15
In P SIMV mode	3-24
In V A/C mode	3-19
In V SIMV mode	3-30
Inspiratory Flow alarm	
Cause & response	5-12
Corrective action	5-22
Inspiratory trigger	4-5
Installation and assembly	
Connecting nurse call cable	6-32
Connecting to power	
External AC	6-3
External DC	6-6
Exhalation block	6-20
Filters	6-17
Humidifier	6-18
Mounting on utility cart	6-30
Oxygen	6-21
Patient circuit	6-9
Using the dual bag	6-26
Ventilator start-up procedure	6-1
Intentional Vent Stop alarm	
Cause & response	5-12
Corrective action	5-22
Intentional Ventilation Stop alarm (setting)	7-7
Internal battery	
Battery capacity	8-2
Battery operation	8-3
Charging (warning)	6-2, 8-6
Maintenance	10-10
Periodic test	10-10
Recharging	8-5
Replacement	10-10
Storage	8-6
Testing	8-5, F-17
Involuntary stop test	F-18

## K

Key sound (setting)	7-18
Keypad Fault alarm	
Cause & response	5-12
Corrective action	5-22

## L

Language (setting)	7-7
Level of priority (alarms)	5-2
Liquids, avoiding ingress into ventilator (warning)	1-5
Locking key	
Disabling	7-35
Enabling	7-35
Locking stud, oxygen inlet (warning)	6-23
Locking the control panel	7-35
Low Battery alarm	
Cause & response	5-12
Corrective action	5-22
Low Battery alarm (warning)	8-4
Low Battery alarm message	1-8
Low expiratory volume alarm test	F-15
Low FiO <sub>2</sub> alarm	
Cause & response	5-13
Corrective action	5-22

---

# Index

Low pressure (alarm) test	F-2
Low priority (LP) alarm (definition)	5-2
Low VTE alarm	
Cause & response	5-13
Corrective action	5-23
Low VTI alarm	
Cause & response	5-13
Corrective action	5-23
<b>M</b>	
Machine hours counter	7-3
In Setup menu	7-6
Maintenance	
In Setup menu	7-11
Recommended schedule	10-7
Manufacturer's declaration	
Compliant cables and accessories	B-13
Conducted and radiated RF	B-13
Electromagnetic emissions	B-12
Electromagnetic immunity	B-12
Max FiO <sub>2</sub> (maximum fraction of inspired oxygen)	
In CPAP mode	3-11
In P A/C mode	3-17
In P SIMV mode	3-26
In PSV mode	3-8
In V A/C mode	3-21
In V SIMV mode	3-33
Max I Time (maximum inspiration time)	
In P SIMV mode	3-24
In PSV mode	3-7
In V SIMV mode	3-31
Max leak (alarm) test	F-3
Max Leak (maximum leakage)	
In CPAP mode	3-10
In P A/C mode	3-16
In PSV mode	3-8
Max P (maximum inspiration pressure)	
In P A/C mode	3-15
In PSV mode	3-6
Max PIP (maximum peak inspiratory pressure)	
In V A/C mode	3-20
In V SIMV mode	3-32
Max Rtot (maximum total breath rate)	
In CPAP mode	3-11
In P A/C mode	3-16
In P SIMV mode	3-26, 3-33
In PSV mode	3-8
In V A/C mode	3-21
Max VTE (maximum exhalation tidal volume)	
In P SIMV mode	3-26
In PSV mode	3-7
In V A/C mode	3-20
In V SIMV mode	3-33
Max VTI (maximum inspiratory tidal volume)	
In CPAP mode	3-10
In P A/C mode	3-16
In P SIMV mode	3-26
In PSV mode	3-7
In V SIMV mode	3-32
Measurement uncertainty	B-4
Medium priority (MP) alarm (definition)	5-2
Menus	
Alarm Logs	5-4
Alarm menu	2-8
Overview	4-1
USB Memory Device menu	2-10
Ventilation menu	2-7
Waveforms	2-9, 4-8
Min FiO <sub>2</sub> (minimum fraction of inspired oxygen)	
In CPAP mode	3-11
In P A/C mode	3-17
In P SIMV mode	3-26
In PSV mode	3-8
In V A/C mode	3-21
In V SIMV mode	3-33
Min I Time (minimum inspiration time)	
In P SIMV mode	3-24
In PSV mode	3-7
In V SIMV mode	3-31
Min PIP (minimum peak inspiratory pressure)	
In V A/C mode	3-20
In V SIMV mode	3-32
Min VTE (minimum exhalation tidal volume)	
In P SIMV mode	3-26
In PSV mode	3-7
In V A/C mode	3-20
In V SIMV mode	3-33
Min VTI (minimum inspiratory tidal volume)	
In CPAP mode	3-10
In P A/C mode	3-16
In P SIMV mode	3-26
In PSV mode	3-7
In V SIMV mode	3-32
Modes	
Changing	
During ventilation	7-23
On standby	7-22
Description	
Assist/Control (A/C) modes	D-1
CPAP (Continuous Positive Airway Pressure) mode	D-2
PSV (Pressure Support Ventilation) mode	D-2
Synchronized Intermittent Mandatory Ventilation (SIMV) modes	D-1
Monitored parameters	B-4
Waveform menu (figure)	4-3
<b>N</b>	
Next (Setup menu)	7-11
NO DATA message (Alarm Logs screen)	5-4
Notes (definition)	1-1
Nurse call cable	
Connecting	6-32
Specifications	B-2
<b>O</b>	
Occlusion (alarm) test	F-9
Occlusion alarm (leak configuration)	
Cause & response	5-13
Corrective action	5-23
Occlusion alarm (valve configuration)	
Cause & response	5-13
Corrective action	5-23

---

# Index

- Operating procedures
  - Locking the control panel .....7-35
  - Setting parameters
    - Alarm .....7-27
    - Preferences menu .....7-14
    - Setup menu .....7-5
    - USB menu .....7-30
    - Ventilation .....7-25
  - Setting ventilation mode .....7-22
  - Starting ventilation .....7-36
  - Stopping ventilation .....7-37
  - Turning off the ventilator .....7-38
  - Turning on the ventilator .....7-1
  - Unlocking the control panel .....7-35
- Operational use (general description) .....2-2
  - Breathing circuit .....2-3
  - Oxygen enrichment .....2-3
  - Safety net .....2-3
  - Settings .....2-3
- Operational verification checklist .....E-1
- O-ring, oxygen coupler (warning) .....1-19,6-23
- Overview of alarms .....5-9
- Oxygen
  - Administering .....6-21
  - Connecting FiO<sub>2</sub> sensor .....6-25
  - Connecting supply .....6-22
  - Coupler O-ring .....1-19,6-23
  - Disconnecting supply .....6-23
  - Inlet stud .....1-19
  - Locking stud on inlet (warning) .....6-23
  - Using medical-grade only (warning) .....1-18,6-22
- P**
  - P A/C (Pressure Assisted/Controlled) mode
    - I Sens (inspiratory trigger sensitivity) .....3-15
    - Insp Time (inspiratory time) .....3-15
    - Max FiO<sub>2</sub> (maximum fraction of inspired oxygen) .....3-17
    - Max Leak (maximum leakage) .....3-16
    - Max P (maximum inspiration pressure) .....3-15
    - Max R<sub>tot</sub> (maximum total breath rate) .....3-16
    - Max VTI (maximum inspiratory tidal volume) .....3-16
    - Min FiO<sub>2</sub> (minimum fraction of inspired oxygen) .....3-17
    - Min VTI (minimum inspiratory tidal volume) .....3-16
    - Parameters
      - Alarm .....3-13
      - Ventilation .....3-12
    - PEEP (positive end expiratory pressure) .....3-14
    - Pi (inspiratory pressure) .....3-13
    - Rate (respiratory rate) .....3-14
    - Rise time .....3-14
    - Vt Target (target tidal volume) .....3-15
  - P SIMV (Synchronized Intermittent Mandatory Ventilation Pressure) mode
    - Apnea time .....3-24
    - E Sens (exhalation sensitivity) .....3-25
    - I Sens (inspiratory trigger sensitivity) .....3-24
    - Insp Time (inspiratory time) .....3-24
    - Max FiO<sub>2</sub> (maximum fraction of inspired oxygen) .....3-26
    - Max I Time (maximum inspiration time) .....3-24
    - Max R<sub>tot</sub> (maximum total breath rate) .....3-26,3-33
    - Max VTE (maximum exhalation tidal volume) .....3-26
    - Max VTI (maximum inspiratory tidal volume) .....3-26
    - Min FiO<sub>2</sub> (minimum fraction of inspired oxygen) .....3-26
    - Min I Time (minimum inspiration time) .....3-24
    - Min VTE (minimum exhalation tidal volume) .....3-26
    - Min VTI (minimum inspiratory tidal volume) .....3-26
    - Parameters
      - Alarm .....3-22
      - Ventilation .....3-22
    - PEEP (positive end expiratory pressure) .....3-23
    - Pi (inspiratory pressure) .....3-22
    - Pressure Support (P Support) .....3-23
    - Rate (respiratory rate) .....3-23
    - Rise time .....3-25
  - P Support (pressure support)
    - In PSV mode .....3-3
  - Parameters
    - Blocking alarm thresholds .....7-29
    - Linked ventilation and alarm parameters .....7-27
    - Linked ventilation parameters .....7-26
    - Monitored (tolerances) .....B-4
    - Preferences menu
      - Access .....7-15
      - Changing parameters .....7-15
      - Exiting .....7-21
    - Setting alarm parameters .....7-25,7-27
    - Setup 2 menu .....7-12
    - Setup menu
      - Access .....7-5
      - Changing parameters .....7-5
      - Exiting .....7-14
  - Parameters (monitored)
    - Bargraph display .....4-7
    - Digital monitoring .....4-1
    - Parameters shown .....4-6
    - Ventilation Report .....4-9
    - Waveform display .....4-8
  - Parameters (operating)
    - CPAP (Continuous Positive Airway Pressure) mode .....3-9
    - FiO<sub>2</sub> for oxygen and ventilator settings .....3-34
    - P A/C (Pressure Assisted/Controlled) mode .....3-12
    - P SIMV (Synchronized Intermittent Mandatory Ventilation Pressure) mode .....3-21
    - PSV (Pressure Support Ventilation) mode .....3-2
    - V A/C (Volume Assisted/Controlled) mode .....3-17
    - V SIMV (Synchronized Intermittent Mandatory Ventilation Volume) mode .....3-27
  - Particular standards compliance .....B-15
  - Parts and accessories .....H-1
  - Patient and caregiver checklist .....A-1
  - Patient circuit
    - Choosing .....6-10
    - Installing
      - Double-limb .....6-13
      - Single-limb (with exhalation valve) .....6-11
      - Single-limb (without exhalation valve) .....6-15
    - Length and internal volume .....6-16
  - Patient Disconnection alarm
    - Cause & response .....5-13
    - Corrective action .....5-24
  - Patient hours counter .....7-3
    - Resetting .....7-8



# Index

- Pausing alarms ..... 5-6
  - Peak inspiratory flow ..... 3-5, 3-25
  - Pediatric circuit (setting) ..... 7-20
  - PEEP (positive end expiratory pressure)
    - In CPAP mode ..... 3-10
    - In P A/C mode ..... 3-14
    - In P SIMV mode ..... 3-23
    - In PSV mode ..... 3-3
    - In V A/C mode ..... 3-18
    - In V SIMV mode ..... 3-29
  - Performance
    - Measurement uncertainty ..... B-4
    - Specifications ..... B-3
  - Personal vehicle use ..... 6-29
  - Physical specifications ..... B-1
  - Pi (inspiratory pressure)
    - In P A/C mode ..... 3-13
    - In P SIMV mode ..... 3-22
  - Pneumatic specifications ..... B-10
  - Pneumatic system ..... 9-3
  - Power failure (alarm) test ..... F-8
  - Power Fault alarm
    - Cause & response ..... 5-13
    - Corrective action ..... 5-24
  - Power On Self Test (POST) ..... 7-3
  - Power Supply Loss alarm
    - Cause & response ..... 5-14
    - Corrective action ..... 5-24
  - Preferences menu
    - Access ..... 7-15
    - Alarm Volume ..... 7-18
    - Apnea Alarm ..... 7-19
    - Backlight ..... 7-16
    - Contrast ..... 7-17
    - Disconnection Alarm ..... 7-20
    - Exiting ..... 7-21
    - Key Sound ..... 7-18
    - Pediatric Circuit ..... 7-20
    - Ventilation Report ..... 7-21
    - Waveforms Display ..... 7-20
  - Pressure (absolute and relative setting) ..... 7-13
  - Pressure bar chart ..... 4-1
  - Pressure control breaths in A/C modes (description) ..... D-4
  - Pressure Sensor Fault 1 alarm
    - Cause & response ..... 5-14
    - Corrective action ..... 5-24
  - Pressure Support (P Support)
    - In P SIMV mode ..... 3-23
    - In V SIMV mode ..... 3-29
  - Pressure supported breaths in SIMV and PSV modes (description) ..... D-8
  - Pressure unit (setting) ..... 7-7
  - Preventive maintenance intervals ..... 10-7
  - Proximal Pressure Sensor Fault 2 alarm
    - Cause & response ..... 5-14
    - Corrective action ..... 5-24
  - PSV (Pressure Support Ventilation) mode
    - Apnea time ..... 3-6
    - Backup R (backup rate) ..... 3-5
    - E Sens (exhalation sensitivity) ..... 3-5
    - I Sens (inspiratory trigger sensitivity) ..... 3-4
    - Max FiO<sub>2</sub> (maximum fraction of inspired oxygen) ..... 3-8
    - Max I Time (maximum inspiration time) ..... 3-7
    - Max Leak (maximum leakage) ..... 3-8
    - Max P (maximum inspiration pressure) ..... 3-6
    - Max Rtot (maximum total breath rate) ..... 3-8
    - Max VTE (maximum exhalation tidal volume) ..... 3-7
    - Max VTI (maximum inspiratory tidal volume) ..... 3-7
    - Menus ..... 3-2
    - Min FiO<sub>2</sub> (minimum fraction of inspired oxygen) ..... 3-8
    - Min I Time (minimum inspiration time) ..... 3-7
    - Min VTE (minimum exhalation tidal volume) ..... 3-7
    - Min VTI (minimum inspiratory tidal volume) ..... 3-7
    - P Support (pressure support) ..... 3-3
  - Parameters
    - Alarm ..... 3-3
    - Ventilation ..... 3-2
  - PEEP (positive end expiratory pressure) ..... 3-3
  - Rise time ..... 3-4
  - Vt Target (target tidal volume) ..... 3-6
  - PSV (Pressure Support Ventilation) mode (description) ..... D-2
- Q**
- Qualification of personnel ..... xvii
- R**
- Ramp
    - In V A/C mode ..... 3-31
  - Ramp Pattern (flow shape)
    - In V A/C mode ..... 3-19
  - Range, resolution, and accuracy specifications ..... B-5
  - Rate (respiratory rate)
    - In P A/C mode ..... 3-14
    - In P SIMV mode ..... 3-23
    - In V A/C mode ..... 3-19
    - In V SIMV mode ..... 3-29
  - Reactivating alarms ..... 5-7
  - Recommended schedule of maintenance
    - Internal battery maintenance ..... 10-10
    - Internal battery periodic test ..... 10-10
    - Internal battery replacement ..... 10-10
    - Preventive maintenance intervals ..... 10-7
  - Remove Valve CPAP Mode alarm
    - Cause & response ..... 5-14
    - Corrective action ..... 5-24
  - Remove Valve or Change Pressure alarm
    - Cause & response ..... 5-14
    - Corrective action ..... 5-24
  - Repairing the ventilator, qualified personnel only (warning) ..... 10-6, 10-9
  - Resetting alarms ..... 5-7
  - Resetting patient hours ..... 7-8
  - Restore default settings ..... 7-10
  - Returning to ventilation mode (circuit check) ..... F-7
  - Rise time
    - In P A/C mode ..... 3-14
    - In P SIMV mode ..... 3-25
    - In PSV mode ..... 3-4
    - In V SIMV mode ..... 3-31
  - Risk of fire (warning) ..... 6-2
  - Routine maintenance
    - Calibration
      - Exhalation flow sensor ..... 10-2
      - FiO<sub>2</sub> sensor ..... 10-4

---

# Index

Expected service life	10-1	Indicators and alarms	B-3
Recommended schedule of maintenance	10-7	Manufacturer's declaration	B-11
Replacing air inlet filter	10-6	Measurement uncertainty	B-4
Service assistance	10-11	Monitored parameters	B-4
<b>S</b>			
Safety information		Performance	B-3
Definitions	1-1	Physical	B-1
Symbols and markings	1-19	Pneumatic	B-10
Warnings	1-1	Range, resolution, and accuracy	B-5
Safety net	2-3	Standards compliance and IEC classification	B-14
Service		USB	B-9
Extended service	xvii	Standards compliance and IEC classification specifications	
Qualification of personnel	xvii	Air transportation standards	B-15
Service centers	xviii	Collateral standards	B-14
Technical support	xvii	General standards	B-14
Service assistance	10-11	Particular standards	B-15
Setting ranges		Starting ventilation	7-36
CPAP (Continuous Positive Airway Pressure) mode	3-9	Stopping ventilation	7-37
P A/C (Pressure Assisted/Controlled) mode	3-12	Storage	8-6
P SIMV (Synchronized Intermittent Mandatory Ventilation Pressure) mode	3-21	Stud (oxygen inlet)	1-19
PSV (Pressure Support Ventilation) mode	3-2	Synchronized Intermittent Mandatory Ventilation (SIMV) modes (description)	D-1
V A/C (Volume Assisted/Controlled) mode	3-17	<b>T</b>	
V SIMV (Synchronized Intermittent Mandatory Ventilation Volume) mode	3-27	Target environments	2-1
Settings	2-3	Target operators	2-2
Setup 2 menu		Target patients	2-1
Absolute and relative pressure	7-13	Technical faults	5-1
Access	7-12	Technical support	xvii
Back	7-14	Testing battery	F-17
Cycling Mode	7-12	Theory of operation	
E Sens Settings	7-13	Altitude compensation feature	C-2
Setup menu		Architecture	C-1
Access	7-5	Operation (general description)	C-1
Alarm tone	7-7	Time (setting)	7-7
Date	7-7	Transfer to USB memory device	
Exiting	7-14	Continuous	7-31
Intentional Vent Stop Alarm	7-7	Trends	7-32
Language	7-7	Transport, emergency (contraindication)	2-2
Machine hours	7-6	Trigger threshold setting	
Maintenance	7-11	modifying (Caution)	3-4
Next	7-11	Troubleshooting	
Patient hours	7-8	Alarms	5-15
Pressure unit	7-7	Other problems	5-25
Restore defaults	7-10	Troubleshooting a failed circuit check	F-7
Time	7-7	Turbine Overheat alarm	
Sigh rate		Cause & response	5-14
In V A/C mode	3-20	Corrective action	5-24
Sigh Vt		Turning off the ventilator	7-38
In V A/C mode	3-19	Turning on the ventilator	7-1
Single-limb patient circuit		<b>U</b>	
Installing		Unfreezing a waveform trace	4-9
Circuit with exhalation valve	6-11	Unknown Battery alarm	
Circuit without exhalation valve	6-15	Cause & response	5-14
Software Version Error alarm		Corrective action	5-24
Cause & response	5-14	Unlocking the control panel	7-35
Corrective action	5-24	USB data transfer characteristics	B-9
Specifications		USB memory device	
Electrical	B-1	Menu	2-10
Environmental	B-9	USB memory device specifications	B-9

# Index

- USB menu
  - Erase data ..... 7-34
  - Transfer continuously ..... 7-31
  - Transfer trends ..... 7-32
- USB specifications ..... B-9
- V**
- V A/C (Volume Assisted/Controlled) mode
  - I Sens (inspiratory trigger sensitivity) ..... 3-19
  - Insp Time (inspiratory time) ..... 3-19
  - Max FiO<sub>2</sub> (maximum fraction of inspired oxygen) ..... 3-21
  - Max PIP (maximum peak inspiratory pressure) ..... 3-20
  - Max Rtot (maximum total breath rate) ..... 3-21
  - Max VTE (maximum exhalation tidal volume) ..... 3-20
  - Min FiO<sub>2</sub> (minimum fraction of inspired oxygen) ..... 3-21
  - Min PIP (minimum peak inspiratory pressure) ..... 3-20
  - Min VTE (minimum exhalation tidal volume) ..... 3-20
  - Parameters
    - Alarm ..... 3-18
    - Ventilation ..... 3-17
  - PEEP (positive end expiratory pressure) ..... 3-18
  - Ramp Pattern (flow shape) ..... 3-19
  - Rate (respiratory rate) ..... 3-19
  - Sigh Rate ..... 3-20
  - Sigh Vt ..... 3-19
  - Vt (tidal volume) ..... 3-18
- V SIMV (Synchronized Intermittent Mandatory Ventilation Volume) mode
  - Apnea time ..... 3-30
  - E Sens (exhalation sensitivity) ..... 3-31
  - I Sens (inspiratory trigger sensitivity) ..... 3-30
  - Insp Time (inspiratory time) ..... 3-30
  - Max FiO<sub>2</sub> (maximum fraction of inspired oxygen) ..... 3-33
  - Max I Time (maximum inspiration time) ..... 3-31
  - Max PIP (maximum peak inspiratory pressure) ..... 3-32
  - Max VTE (maximum exhalation tidal volume) ..... 3-33
  - Max VTI (maximum inspiratory tidal volume) ..... 3-32
  - Min FiO<sub>2</sub> (minimum fraction of inspired oxygen) ..... 3-33
  - Min I Time (minimum inspiration time) ..... 3-31
  - Min PIP (minimum peak inspiratory pressure) ..... 3-32
  - Min VTE (minimum exhalation tidal volume) ..... 3-33
  - Min VTI (minimum inspiratory tidal volume) ..... 3-32
  - Parameters
    - Alarm ..... 3-28
    - Ventilation ..... 3-27
  - PEEP (positive end expiratory pressure) ..... 3-29
  - Pressure Support (P Support) ..... 3-29
  - Ramp) ..... 3-31
  - Rate (respiratory rate) ..... 3-29
  - Rise time ..... 3-31
  - Vt (tidal volume) ..... 3-28
- Valve Missing alarm
  - Cause & response ..... 5-14
  - Corrective action ..... 5-25
- Ventilation
  - Menu ..... 2-7
  - Modes ..... 2-2
  - Starting ..... 7-36
  - Stopping ..... 7-37
- Ventilation modes
  - Changing during ventilation ..... 7-23
  - Changing on standby ..... 7-22
- Ventilation parameters
  - Links between parameters ..... 7-26
  - Links with alarm parameters ..... 7-27
  - Setting ..... 7-25
- Ventilation Report ..... 4-9
  - Access ..... 7-21
- Ventilator
  - Cleaning ..... 9-1
  - Connecting nurse call cable ..... 6-32
  - Connections (warning) ..... 6-2, 6-9
  - Connections, proper (warning) ..... 1-5
  - Exhalation block ..... 6-20
  - Expected service life ..... 10-1
  - Failure ..... 2-10
  - Filters ..... 6-17
  - Humidifier ..... 6-18
  - Labels ..... 1-24
  - Liquid ingress (warning) ..... 1-5
  - Mounting on utility cart ..... 6-30
  - Parts and accessories ..... H-1
  - Patient circuit ..... 6-9
  - Pneumatic system ..... 9-3
  - Recommended schedule of maintenance ..... 10-7
  - Repair (warning) ..... 10-1
  - Setting alarm parameters ..... 7-27
  - Setting ventilation mode ..... 7-22
  - Setting ventilation parameters ..... 7-25
  - Specifications ..... B-1
  - Symbols and markings ..... 1-19
  - Theory of operation ..... C-1
  - Turning off ..... 7-38
  - Turning on ..... 7-1
  - USB memory device specifications ..... 7-30
  - Use with dual bag ..... 6-26
- Ventilator overview
  - Alarm menu ..... 2-8
  - Back panel ..... 2-5
  - Contraindications ..... 2-2
  - Control panel ..... 2-6
  - Device classification ..... 2-3
  - Front panel ..... 2-4
  - Indications for use
    - Target environments ..... 2-1
    - Target operators ..... 2-2
    - Target patients ..... 2-1
  - Operational use
    - Breathing circuit ..... 2-3
    - Oxygen enrichment ..... 2-3
    - Safety net ..... 2-3
    - Settings ..... 2-3
  - Operational use (general) ..... 2-2
  - USB memory device menu ..... 2-10
  - Ventilation menu ..... 2-7
  - Ventilator failure ..... 2-10
  - Waveform menu ..... 2-9
- Ventilator standby indicator ..... 7-3
- Very high priority (VHP) alarm (definition) ..... 5-2
- Volume breaths in A/C modes (description) ..... D-2

---

# Index

Volume breaths in V SIMV mode (description) .....	D-5
Vt (tidal volume)	
In V A/C mode .....	3-18
In V SIMV mode .....	3-28
Vt Target (target tidal volume)	
In P A/C mode .....	3-15
In PSV mode .....	3-6
VTI Not Reached alarm	
Cause & response .....	5-14
Corrective action .....	5-25
<b>W</b>	
Warnings	
Definition .....	1-1
Electrical power supplies .....	1-7
Electromagnetic interference .....	1-19
General (use of equipment) .....	1-1
Hoses and accessories .....	1-8
Installation and environment of use .....	1-4
Maintenance .....	1-14
Oxygen .....	1-17
PC connection and USB memory devices .....	1-14
Settings .....	1-11
Warranty .....	.xvii
Waveform menu .....	4-8
monitored parameters (figure) .....	4-3
Waveform tracing	
Freezing a waveform trace .....	4-8
Unfreezing .....	4-9
Waveforms display (setting) .....	7-20
Waveforms menu .....	2-9
Welcome Menu screen	
Screen information .....	7-3
Skipping to start ventilation .....	7-4
Wheelchair use .....	6-27




**Rx**  
**ONLY**


**CE**  
0123

Part No. PT00106572 Rev A 2019-07

© 2019 Covidien. All rights reserved.

 Covidien llc

15 Hampshire Street, Mansfield, MA 02048 USA

 Covidien Ireland Limited, IDA Business and Technology Park, Tullamore.

[www.Medtronic.com](http://www.Medtronic.com)

[T] 1 800 635 5267

 **COVIDIEN**